

8 7 6 5 4 3 2 1

D  
C  
B  
A

D  
C  
B  
A

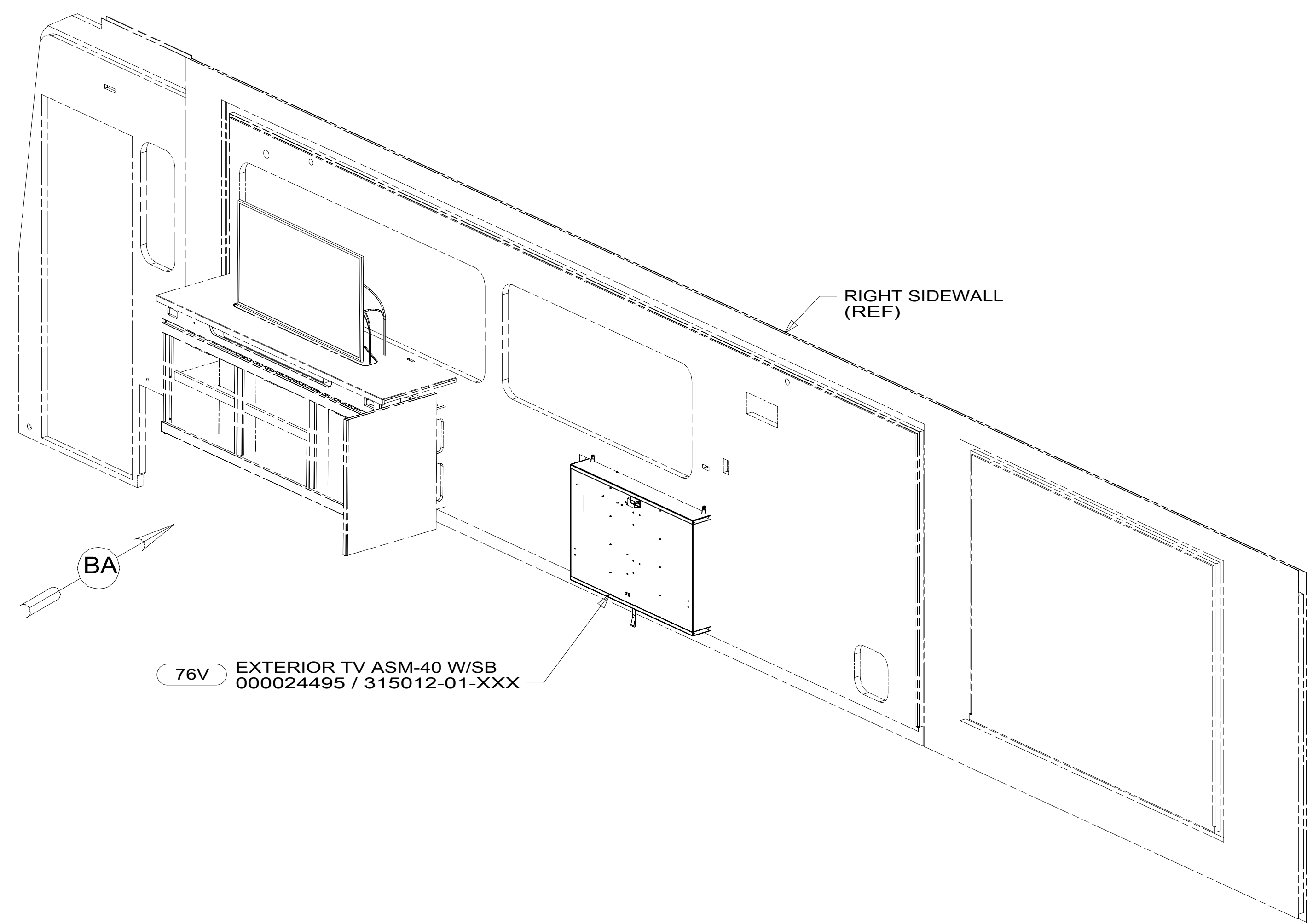
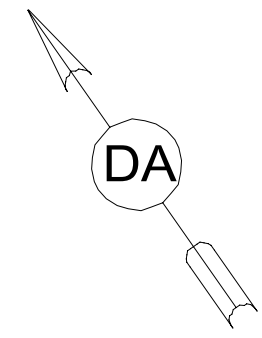
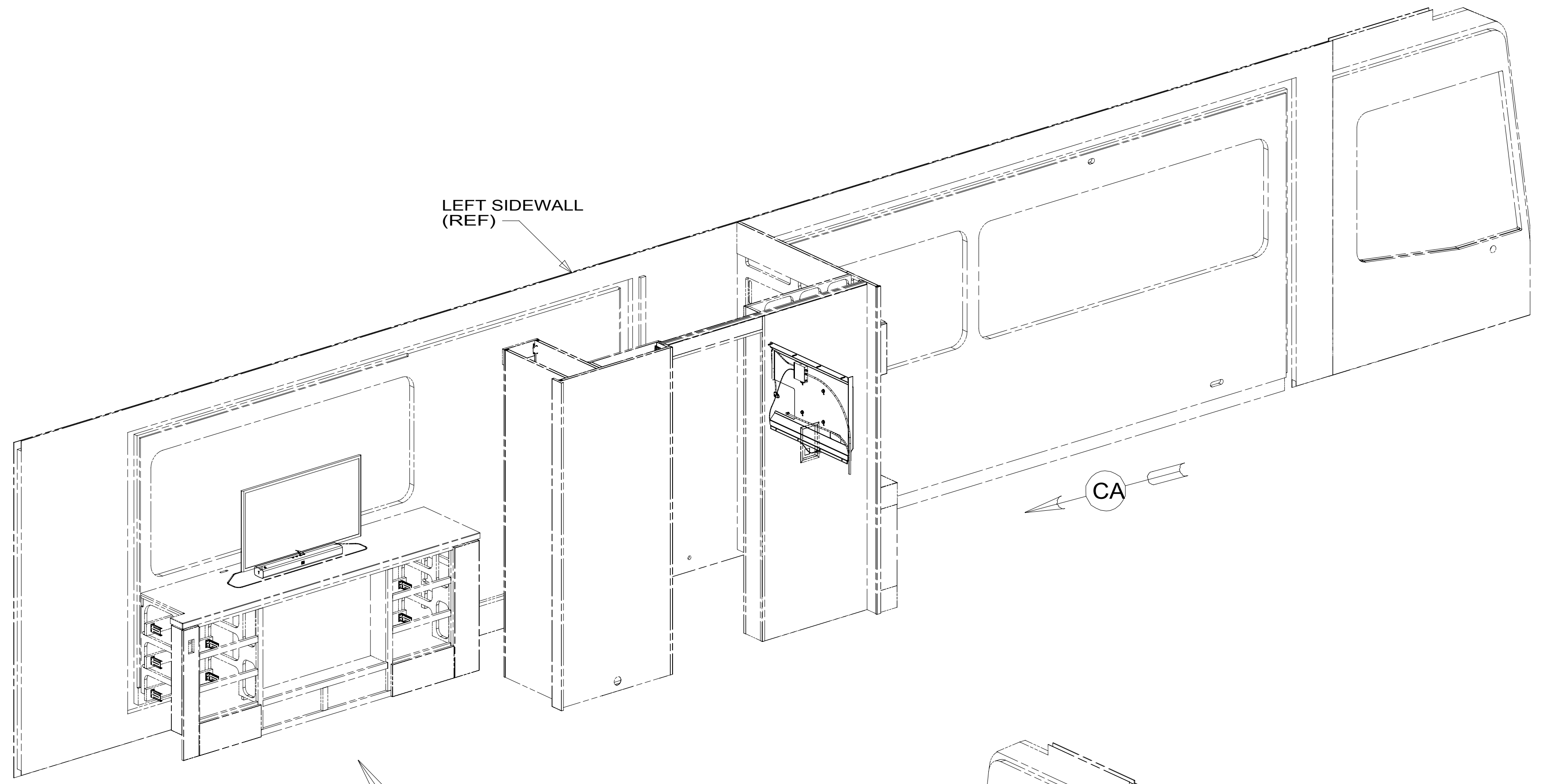

76V EXTERIOR TV ASM-40 W/SB  
000024495 / 315012-01-XXX

- 76V EXT ENT CTR W/TV & SOUNDBAR
- 265 CODES/STANDARDS-CSA/CMVSS
- 1B1 CODES/STANDARDS USA

1B1 265



DSNR:	ALL DIMENSIONS ARE IN MILLIMETERS	
DFTR:	MATERIAL:	
UNSPECIFIED TOLERANCES:		
WHOLE DIM (X)	: 3	
ONE-PLACE (X.X)	: 1.5	
TWO-PLACE (X.XX)	: 0.50	
ANGLE	: 1°	
REFER TO ES0018 FOR FASTENER TIGHTENING GUIDELINES	WEIGHT: (LBS)	FIRST USED:
		18 P40A

FOR ELECTRICAL TORQUE SPECIFICATIONS SEE DWG NO. 128783-01-000

FOR ELECTRICAL CALLOUTS SEE DWG NO. 121339-01-000

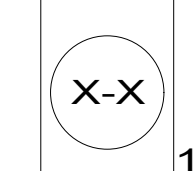

DESCRIPTION: **WIRING INSTL-A/V, COACH**

SHEET: 1 OF 4 ITEM/PART NO.: 000026368 / 31560601000 REF: 1 07-Nov-2018

8 7 6 5 4 3 2 1

8 7 6 5 4 3 2 1

D  
C  
B  
A

D  
C  
B  
A

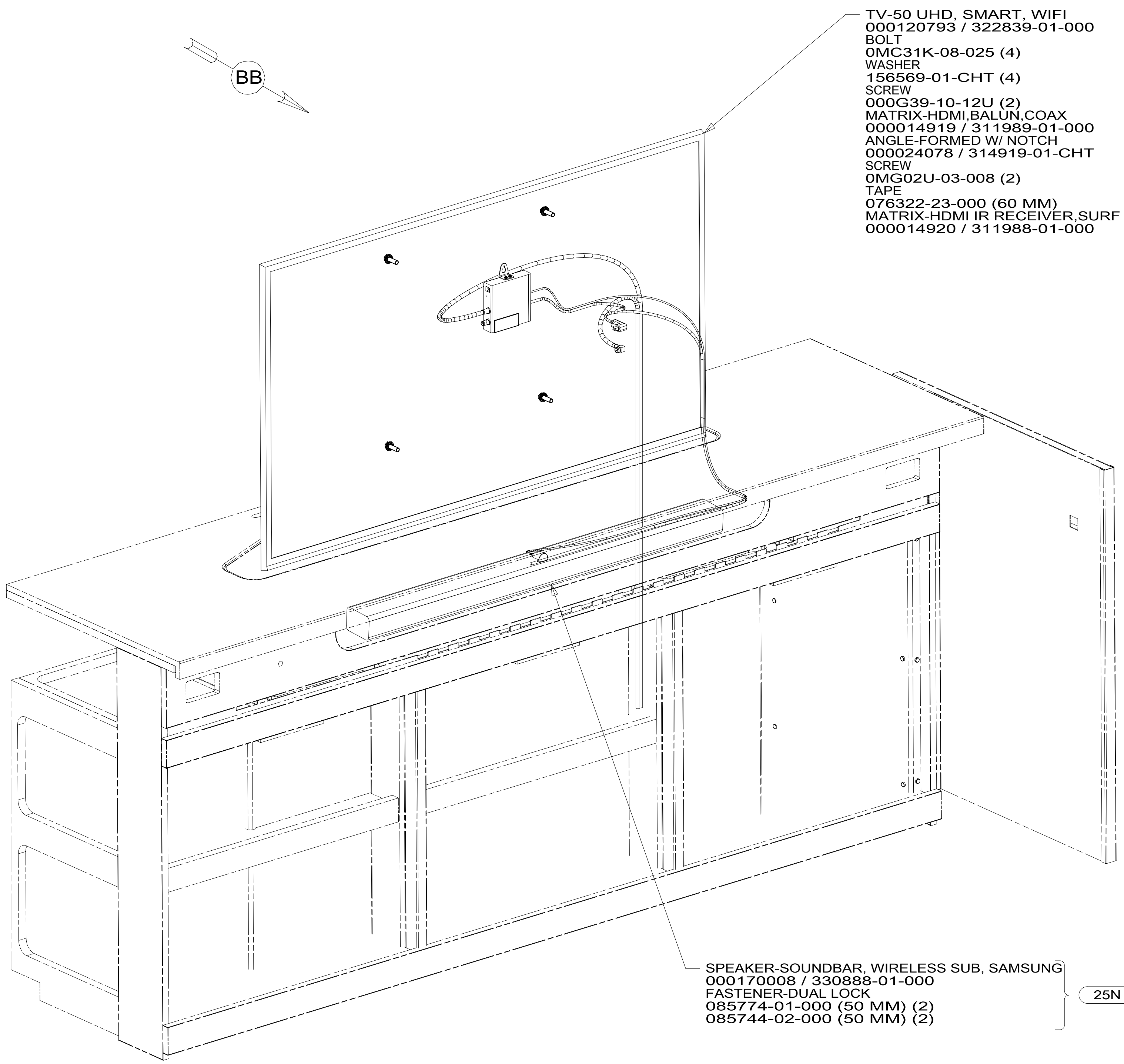

VIEW BA

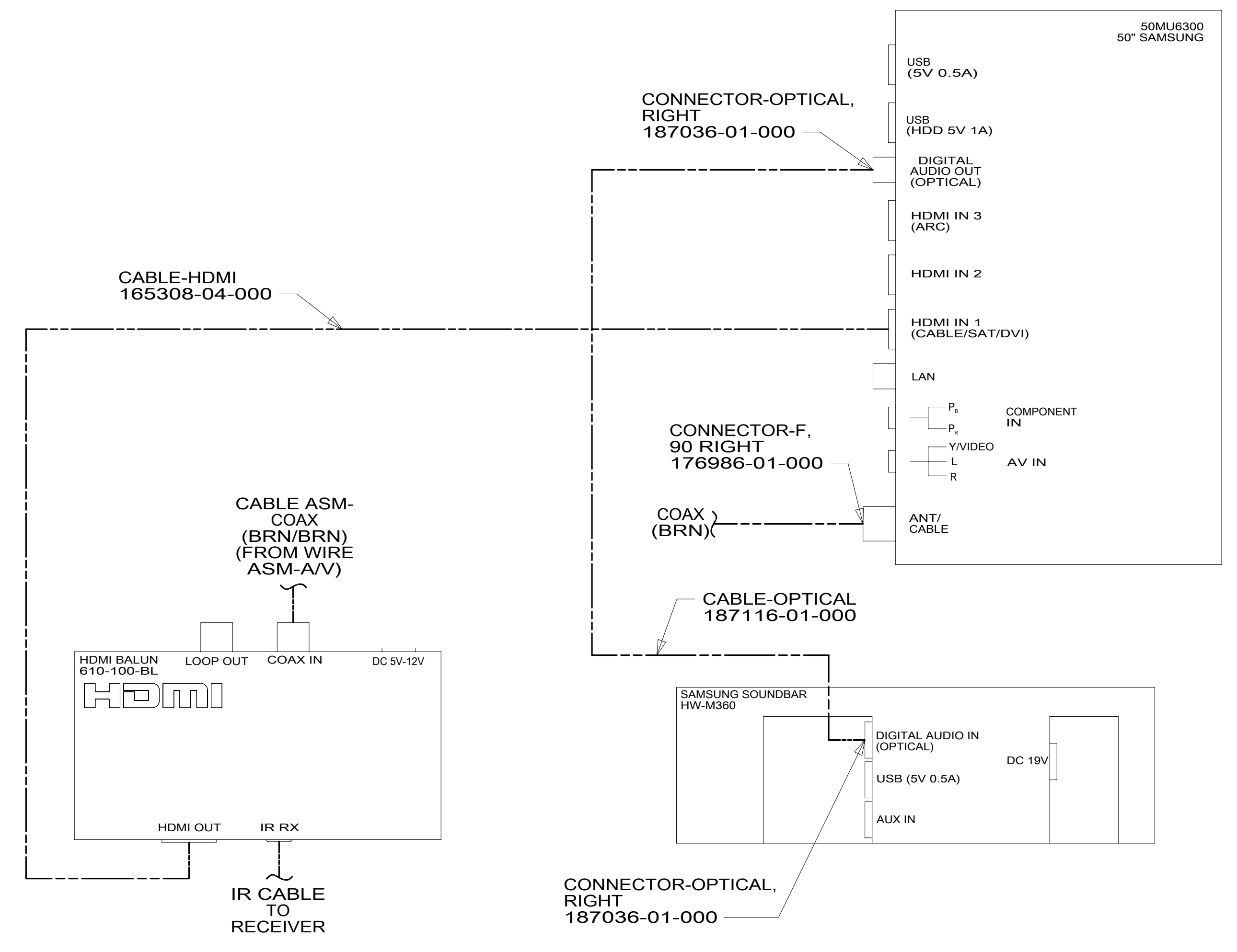
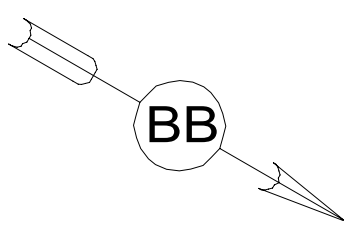

VIEW BB

- 79H ENTERTAINMENT CTR-INTERIOR
- 25N HOME THEATER SOUNDBAR SYSTEM
- 265 CODES/STANDARDS-CSA/CMVSS
- 1B1 CODES/STANDARDS USA

FOR ELECTRICAL TORQUE SPECIFICATIONS SEE DWG NO. 128783-01-000

FOR ELECTRICAL CALLOUTS SEE DWG NO. 121339-01-000

DESCRIPTION: <b>WIRING INSTL-A/V, COACH</b>		
SHEET: 2 OF 4	ITEM/PART NO.: 000026368 / 31560601000	REV
1B1 265 79H		
07-Nov-2018		

8 7 6 5 4 3 2 1

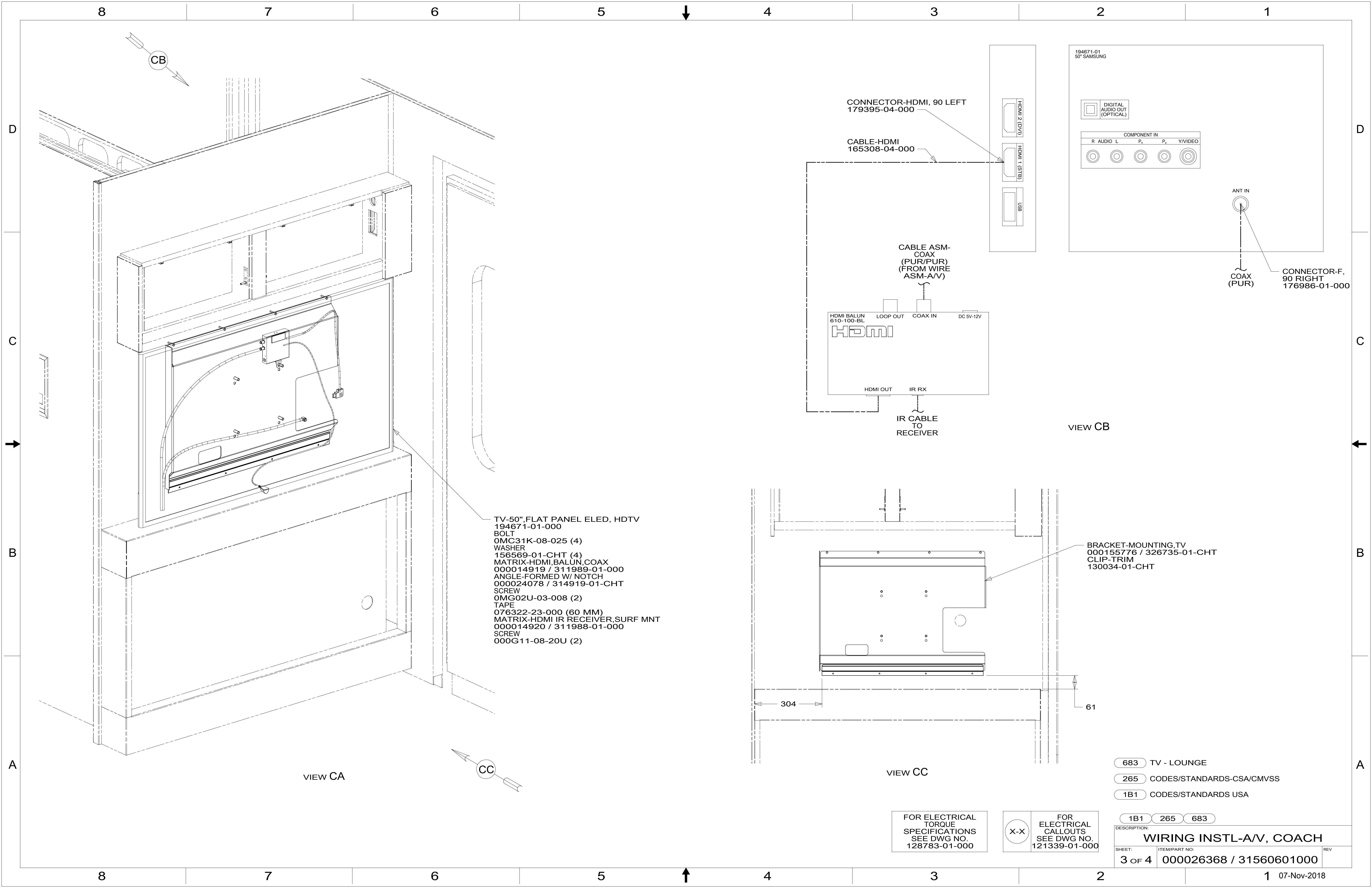

VIEW CA

- TV-50",FLAT PANEL ELED, HDTV  
194671-01-000
- BOLT  
OMC31K-08-025 (4)
- WASHER  
156569-01-CHT (4)
- MATRIX-HDMI,BALUN,COAX  
000014919 / 311989-01-000
- ANGLE-FORMED W/ NOTCH  
000024078 / 314919-01-CHT
- SCREW  
OMG02U-03-008 (2)
- TAPE  
076322-23-000 (60 MM)
- MATRIX-HDMI IR RECEIVER,SURF MNT  
000014920 / 311988-01-000
- SCREW  
000G11-08-20U (2)

VIEW CB

CONNECTOR-HDMI, 90 LEFT  
179395-04-000

CABLE-HDMI  
165308-04-000

CABLE ASM-  
COAX  
(PUR/PUR)  
(FROM WIRE  
ASM-A/V)

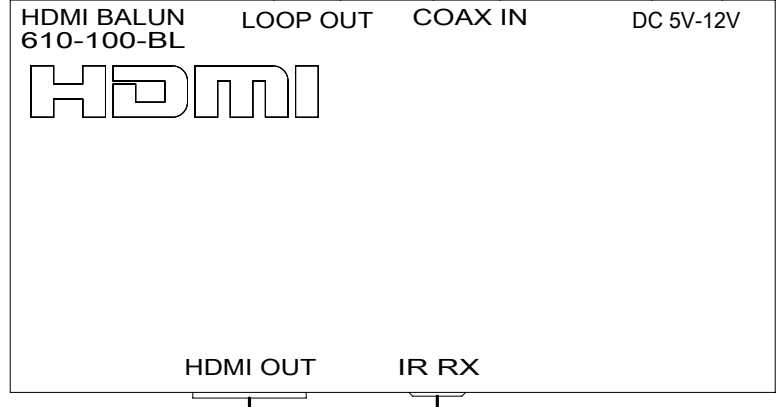

IR CABLE  
TO  
RECEIVER

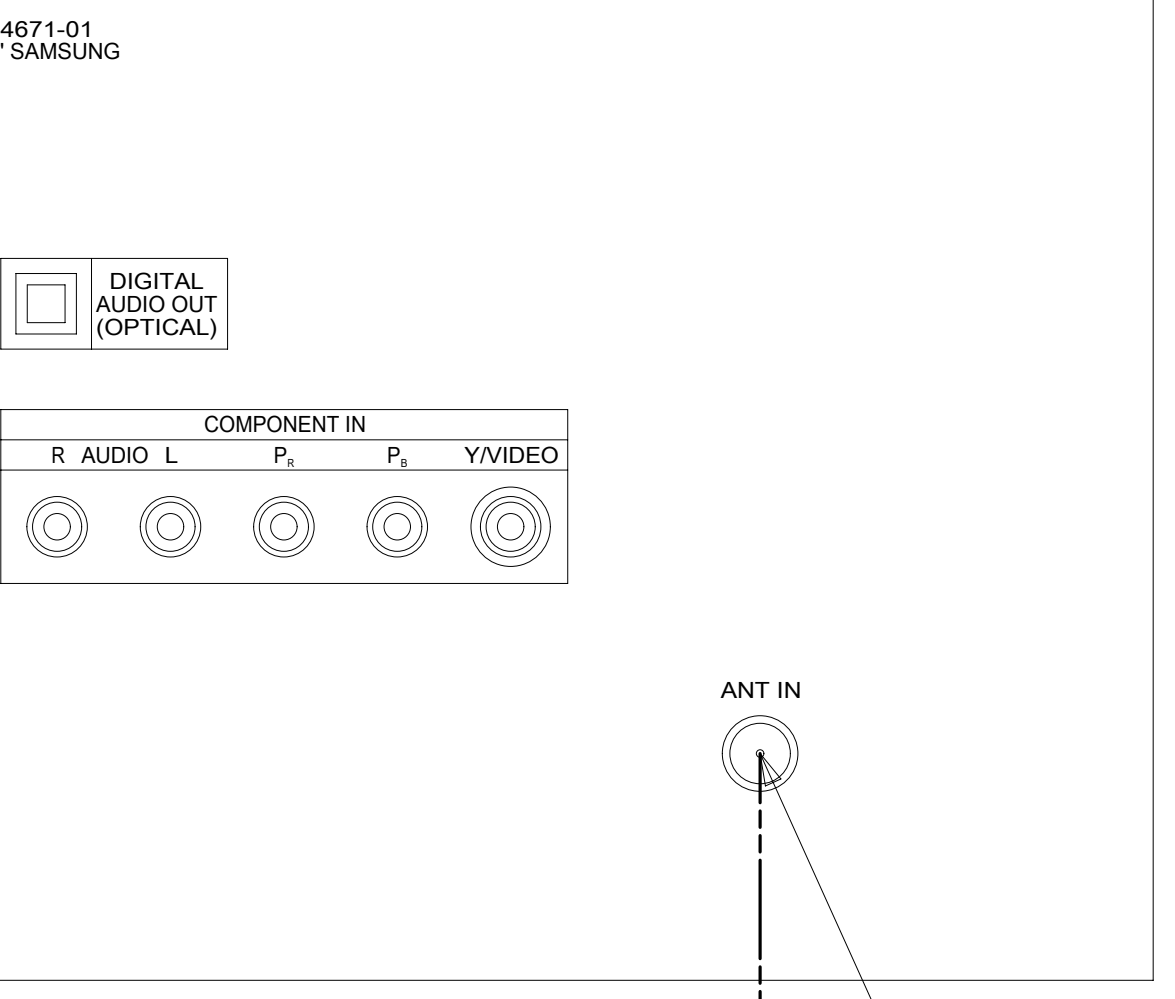

CONNECTOR-F,  
90 RIGHT  
176986-01-000

BRACKET-MOUNTING,TV  
000155776 / 326735-01-CHT  
CLIP-TRIM  
130034-01-CHT

VIEW CC

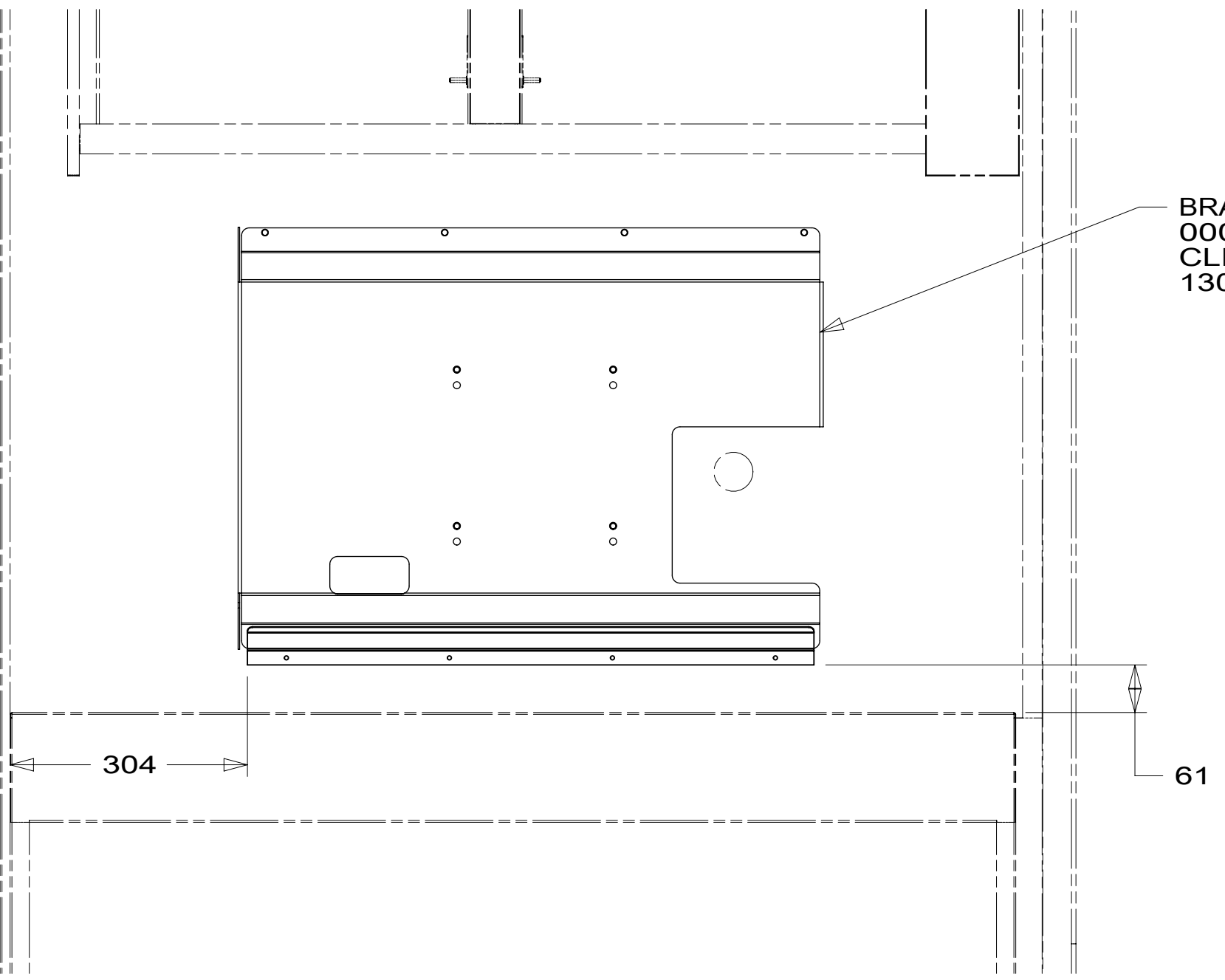

- 683 TV - LOUNGE
- 265 CODES/STANDARDS-CSA/CMVSS
- 1B1 CODES/STANDARDS USA

FOR ELECTRICAL  
TORQUE  
SPECIFICATIONS  
SEE DWG NO.  
128783-01-000

FOR  
ELECTRICAL  
CALLOUTS  
SEE DWG NO.  
121339-01-000

DESCRIPTION:	1B1 265 683	
<b>WIRING INSTL-A/V, COACH</b>		
SHEET:	ITEM/PART NO:	REV
3 OF 4	000026368 / 31560601000	

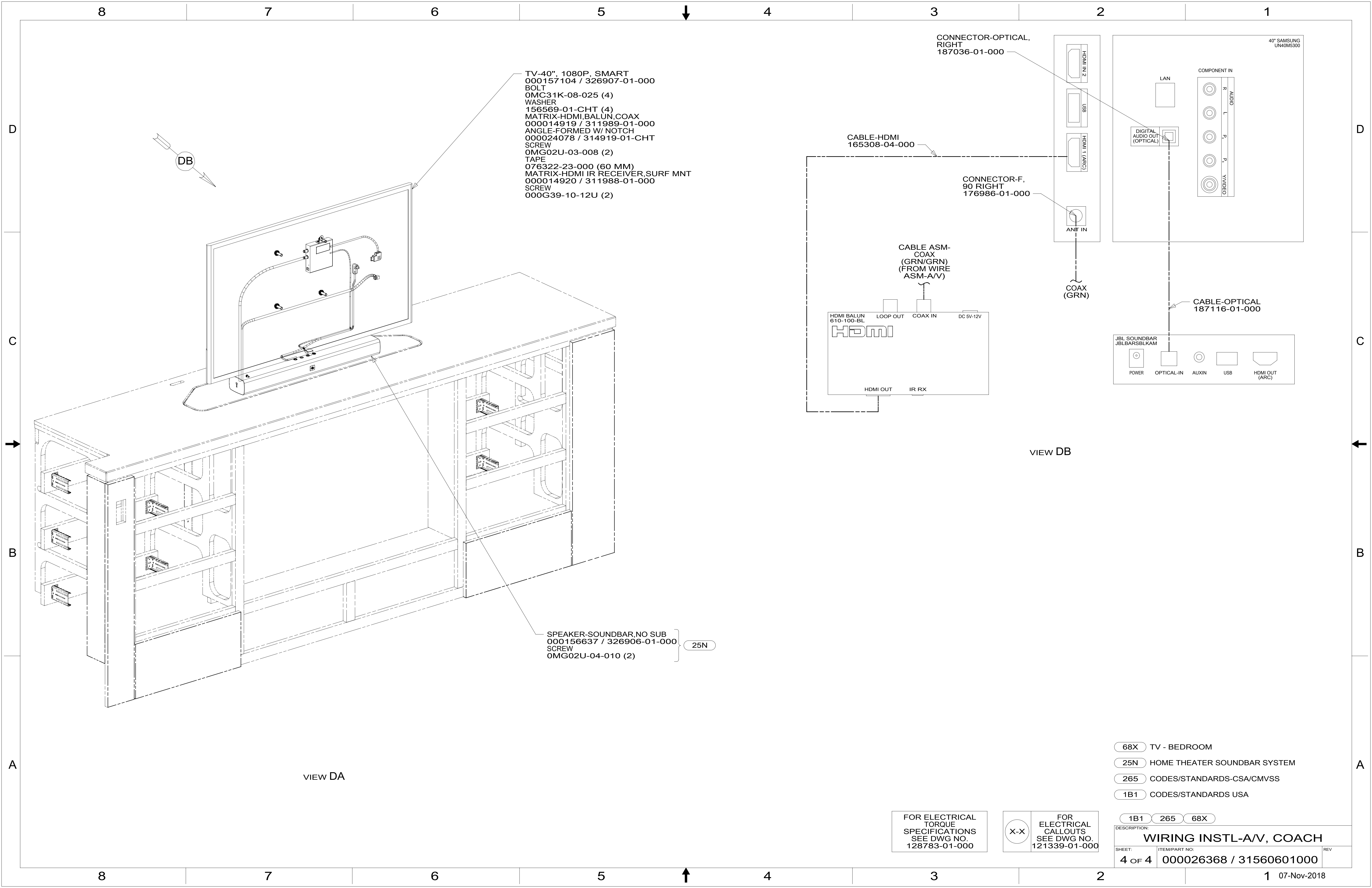

TV-40", 1080P, SMART  
 000157104 / 326907-01-000  
 BOLT  
 OMC31K-08-025 (4)  
 WASHER  
 156569-01-CHT (4)  
 MATRIX-HDMI,BALUN,COAX  
 000014919 / 311989-01-000  
 ANGLE-FORMED W/ NOTCH  
 000024078 / 314919-01-CHT  
 SCREW  
 OMG02U-03-008 (2)  
 TAPE  
 076322-23-000 (60 MM)  
 MATRIX-HDMI IR RECEIVER,SURF MNT  
 000014920 / 311988-01-000  
 SCREW  
 000G39-10-12U (2)

SPEAKER-SOUNDBAR,NO SUB  
 000156637 / 326906-01-000  
 SCREW  
 OMG02U-04-010 (2) 25N

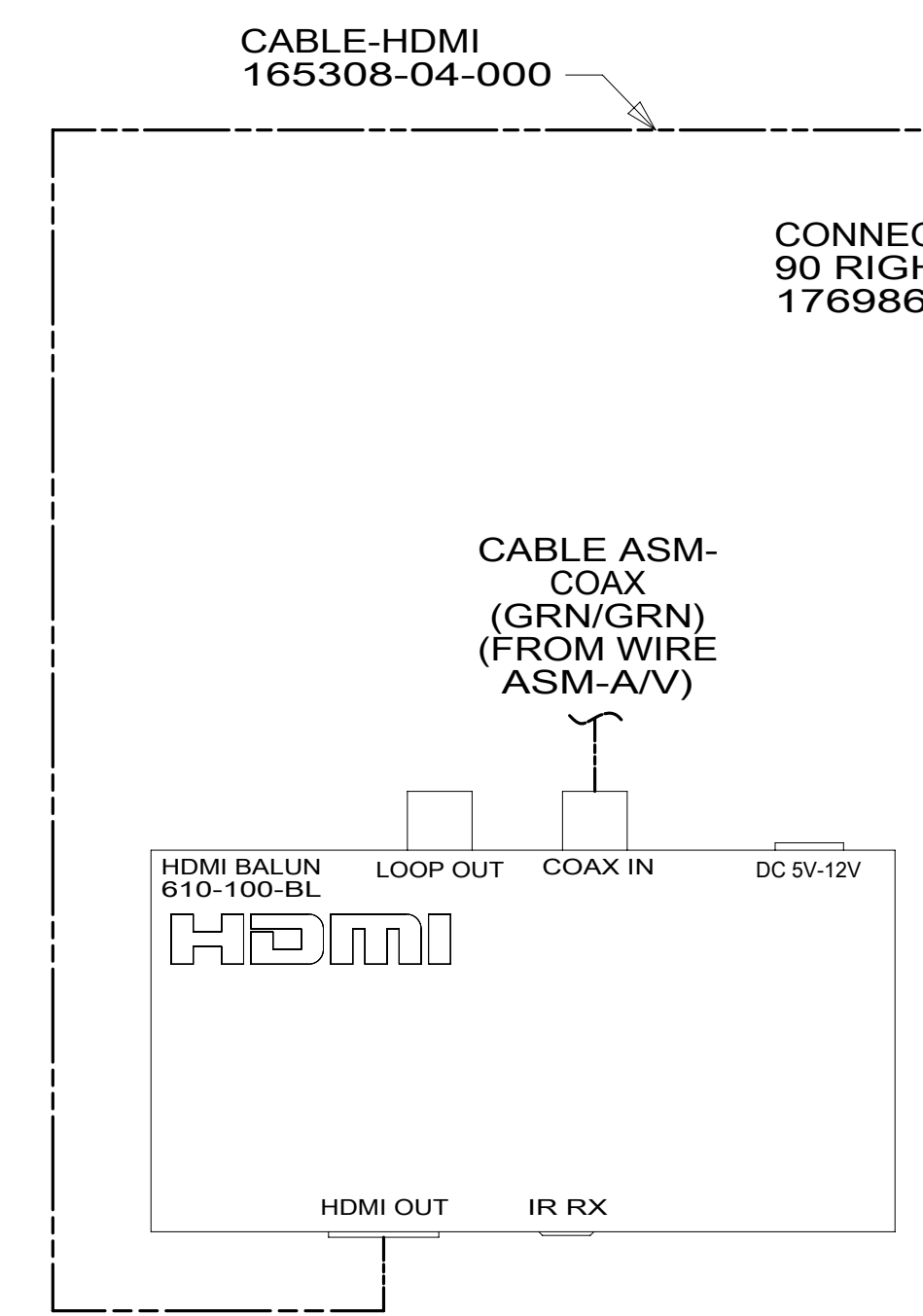
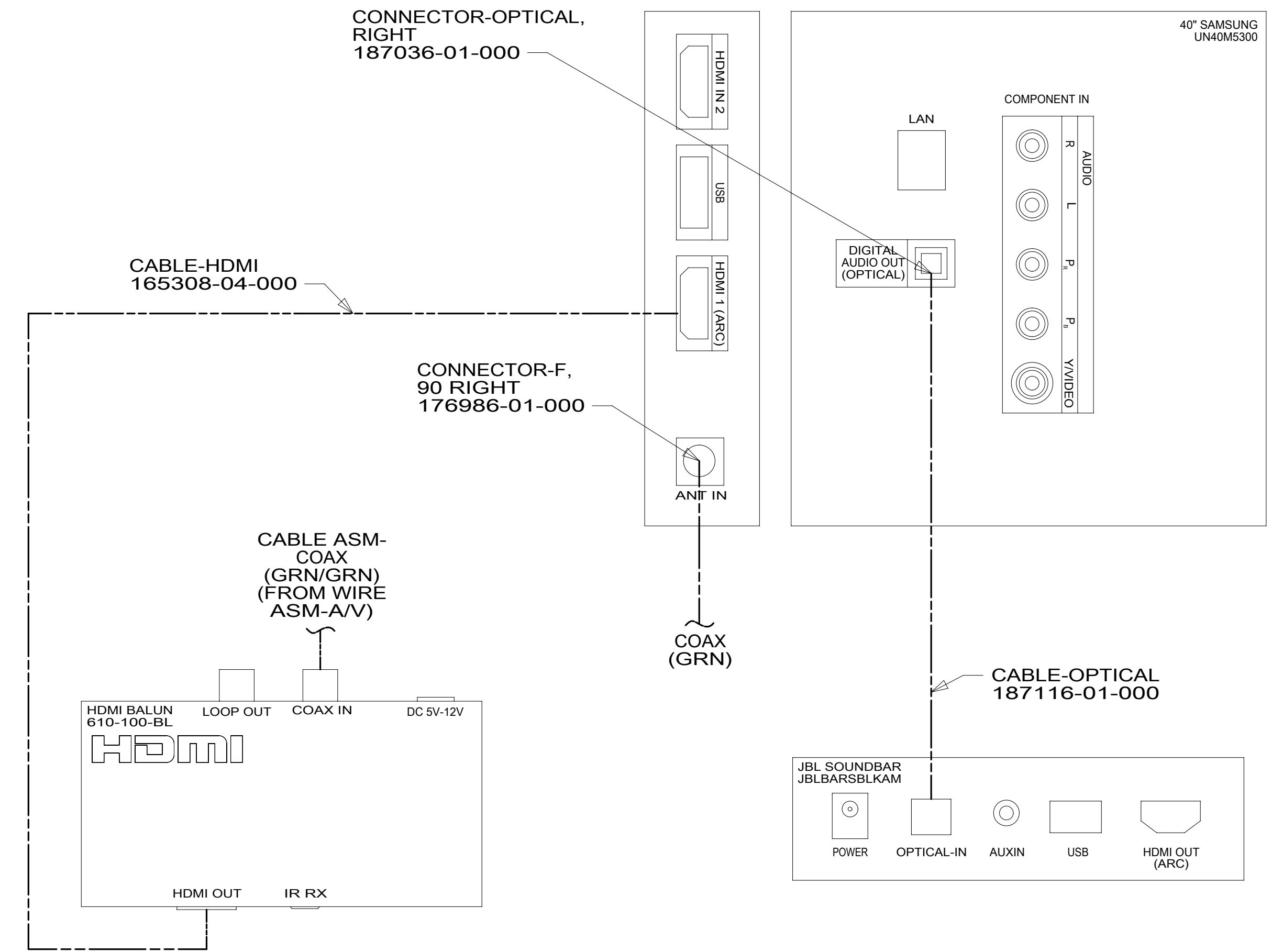

VIEW DB

VIEW DA

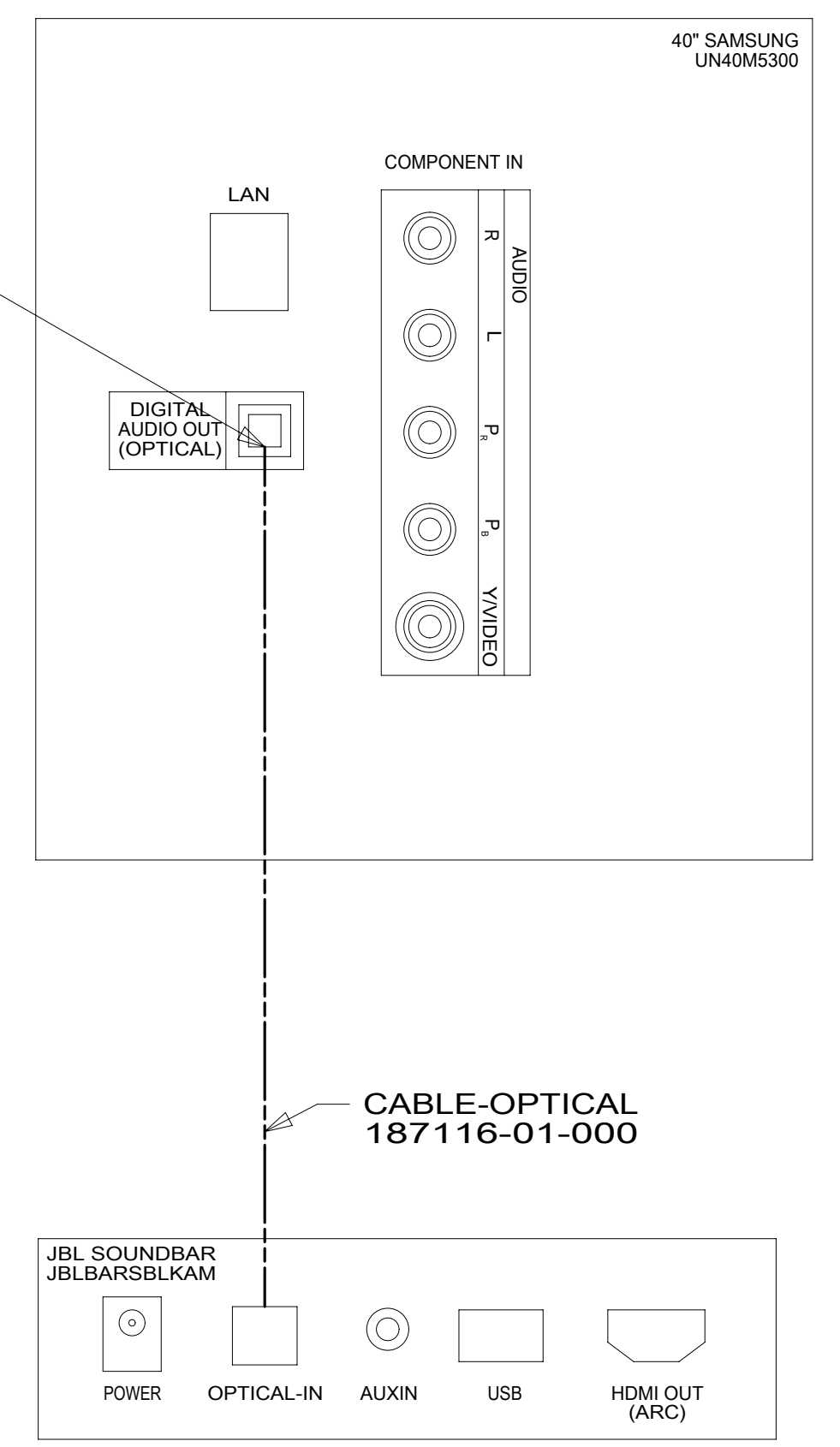

FOR ELECTRICAL TORQUE SPECIFICATIONS SEE DWG NO. 128783-01-000

FOR ELECTRICAL CALLOUTS SEE DWG NO. 121339-01-000

- 68X TV - BEDROOM
- 25N HOME THEATER SOUNDBAR SYSTEM
- 265 CODES/STANDARDS-CSA/CMVSS
- 1B1 CODES/STANDARDS USA

DESCRIPTION:	1B1 265 68X	
<b>WIRING INSTL-A/V, COACH</b>		
SHEET:	ITEM/PART NO.:	REV
4 OF 4	000026368 / 31560601000	