

- NOTES:**
- 4 WIRE PASSES THROUGH FLOOR IN THIS AREA.
  - 3 PLACE CROSS LOCATOR ON SENSORS OVER DIMPLES ON TANK.
  - 2. ROUTE TANK SENSOR WIRES SO THEY DO NOT PASS OVER SENSORS. USE WIRE TIE MOUNT 155366-01-000 AND WIRE TIE 8343-01-000 AS NEEDED. TANK SURFACE MUST BE CLEANED USING ISOPROPYL ALCOHOL AND PRIMED WITH PRIMER 94.
  - 1. AT MINIMUM ALL WIRES TO BE SUPPORTED AND SECURED PER CODE REQUIREMENTS. USE CLAMP 10495 OR 10497 OR WIRE TIE 8343 OR 108046 AND SCREW G67-XX-XXX OR G56-XX-XXX AS APPROPRIATE FOR INSTALLATION.

- 299 ENTERTAINMENT CENTER EXT. W/O
- 1D3 ENTERTAIN CENTR/EXT TV-DVD
- 265 CODES/STANDARDS-CSA/CMVSS
- 1B1 CODES/STANDARDS USA

**WINNEBAGO**  
COPYRIGHT 2016 WINNEBAGO INDUSTRIES, INC.

DSNR:	ALL DIMENSIONS ARE IN MILLIMETERS	
DFTFR:	MATERIAL:	
UNSPECIFIED TOLERANCES:		
WHOLE DIM (X)	: 3	
ONE-PLACE (X.X)	: 1.5	
TWO-PLACE (X.XX)	: 0.50	
ANGLE	: 1°	
REFER TO ES0018 FOR FASTENER TIGHTENING GUIDELINES	WEIGHT: (LBS)	FIRST USED:
		<b>17 E35F</b>
<b>DESCRIPTION:</b>		
<b>WIRING INSTL-BODY, 12V</b>		
SHEET:	ITEM/PART NO.:	REV:
<b>1 OF 8</b>	<b>000002440 / 31200501000</b>	
REF:		

FOR ELECTRICAL TORQUE SPECIFICATIONS SEE DWG NO. 128783-01-000

FOR ELECTRICAL CALLOUTS SEE DWG NO. 121339-01-000

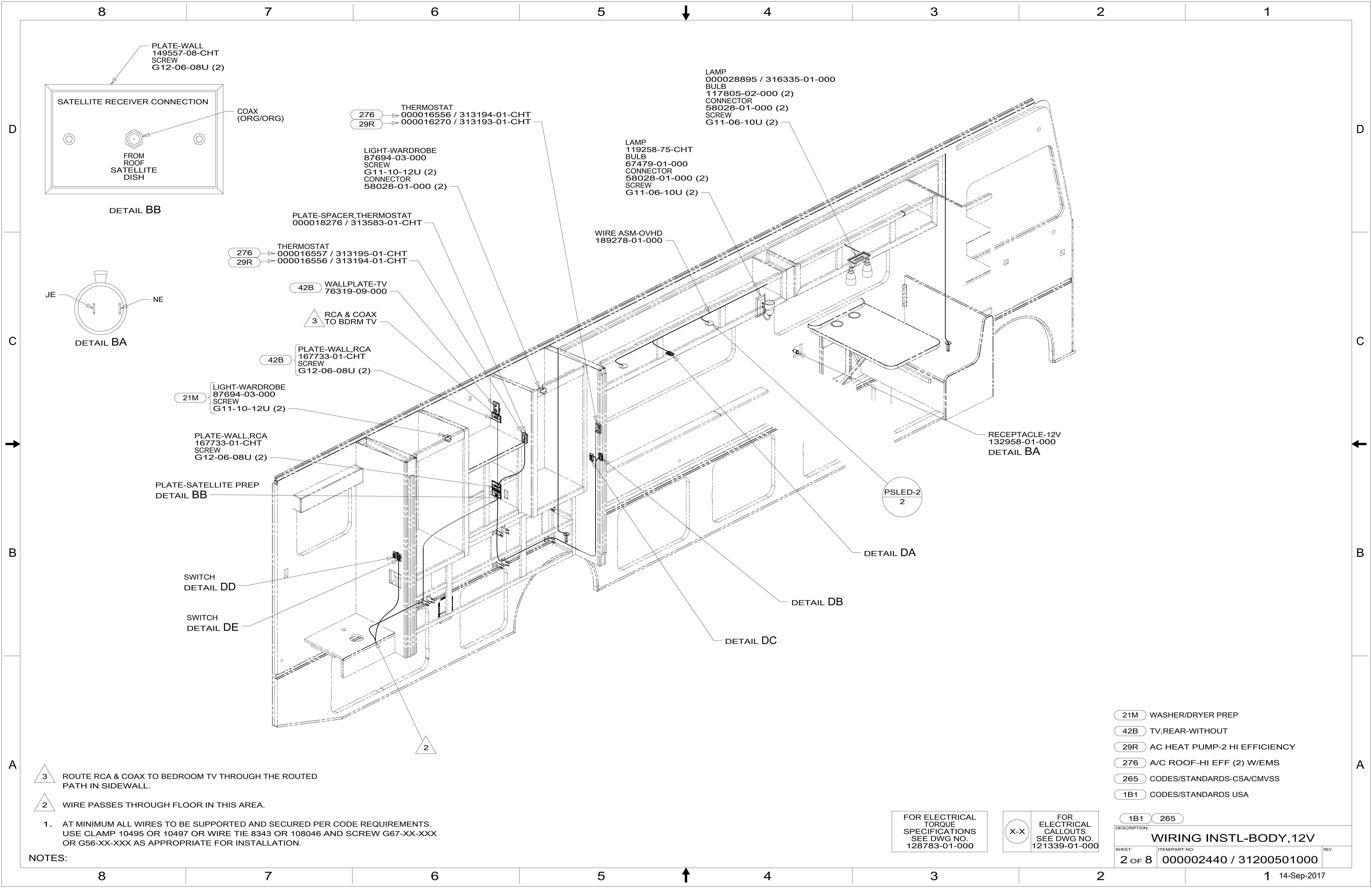
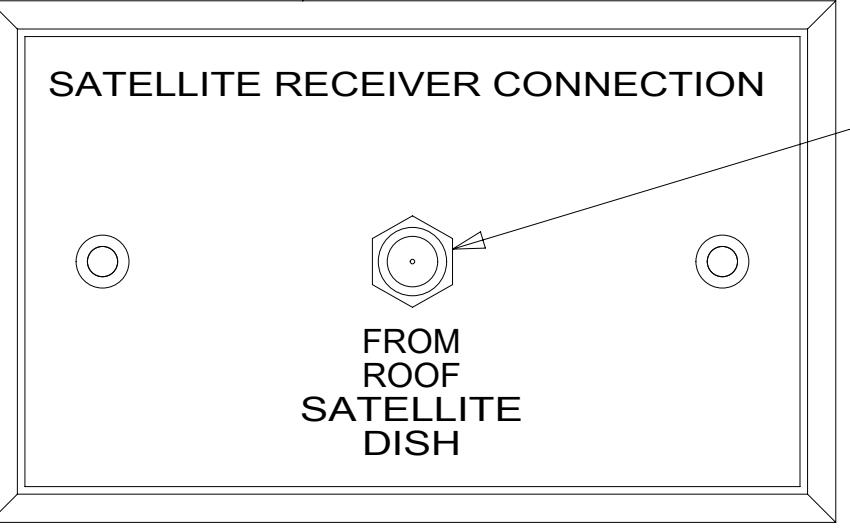

PLATE-WALL  
149557-08-CHT  
SCREW  
G12-06-08U (2)



DETAIL BB

COAX  
(ORG/ORG)

276 THERMOSTAT 000016556 / 313194-01-CHT  
29R 000016270 / 313193-01-CHT

LIGHT-WARDROBE  
87694-03-000  
SCREW  
G11-10-12U (2)  
CONNECTOR  
58028-01-000 (2)

LAMP  
000028895 / 316335-01-000  
BULB  
117805-02-000 (2)  
CONNECTOR  
58028-01-000 (2)  
SCREW  
G11-06-10U (2)

LAMP  
119258-75-CHT  
BULB  
67479-01-000  
CONNECTOR  
58028-01-000 (2)  
SCREW  
G11-06-10U (2)

PLATE-SPACER,THERMOSTAT  
000018276 / 313583-01-CHT

WIRE ASM-OVHD  
189278-01-000

276 THERMOSTAT 000016557 / 313195-01-CHT  
29R 000016556 / 313194-01-CHT

42B WALLPLATE-TV  
76319-09-000

3 RCA & COAX  
TO BDRM TV

42B PLATE-WALL,RCA  
167733-01-CHT  
SCREW  
G12-06-08U (2)

21M LIGHT-WARDROBE  
87694-03-000  
SCREW  
G11-10-12U (2)

PLATE-WALL,RCA  
167733-01-CHT  
SCREW  
G12-06-08U (2)

PLATE-SATELLITE PREP  
DETAIL BB

RECEPTACLE-12V  
132958-01-000  
DETAIL BA

PSLED-2  
2

DETAIL DA

SWITCH  
DETAIL DD

DETAIL DB

SWITCH  
DETAIL DE

DETAIL DC

3 ROUTE RCA & COAX TO BEDROOM TV THROUGH THE ROUTED PATH IN SIDEWALL.

2 WIRE PASSES THROUGH FLOOR IN THIS AREA.

1. AT MINIMUM ALL WIRES TO BE SUPPORTED AND SECURED PER CODE REQUIREMENTS. USE CLAMP 10495 OR 10497 OR WIRE TIE 8343 OR 108046 AND SCREW G67-XX-XXX OR G56-XX-XXX AS APPROPRIATE FOR INSTALLATION.

NOTES:

- 21M WASHER/DRYER PREP
- 42B TV,REAR-WITHOUT
- 29R AC HEAT PUMP-2 HI EFFICIENCY
- 276 A/C ROOF-HI EFF (2) W/EMS
- 265 CODES/STANDARDS-CSA/CMVSS
- 1B1 CODES/STANDARDS USA

FOR ELECTRICAL TORQUE SPECIFICATIONS SEE DWG NO. 128783-01-000

FOR ELECTRICAL CALLOUTS SEE DWG NO. 121339-01-000

DESCRIPTION: <b>WIRING INSTL-BODY, 12V</b>	
SHEET: 2 OF 8	ITEM/PART NO: 000002440 / 31200501000
REV	

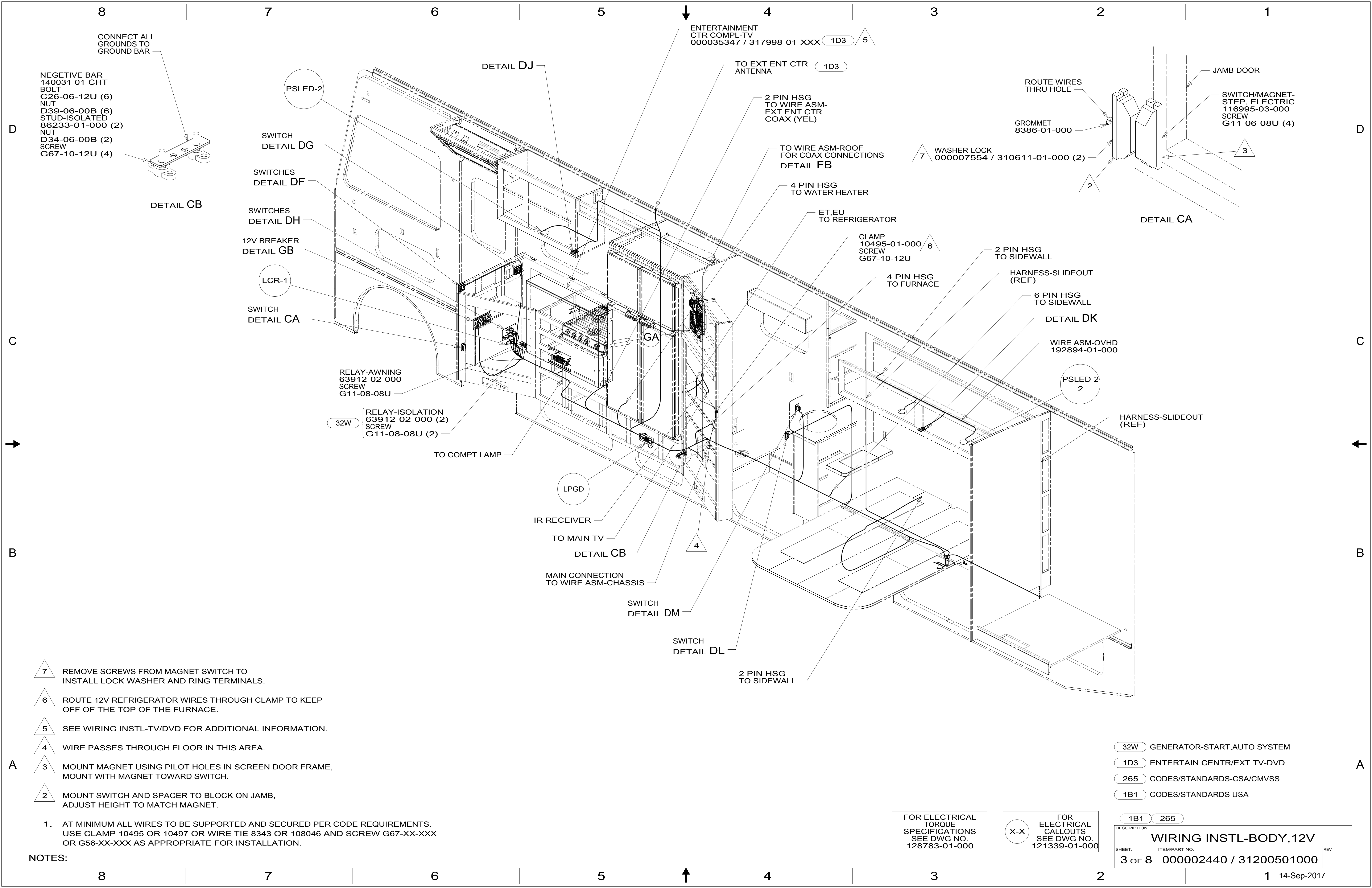

CONNECT ALL GROUNDS TO GROUND BAR

- NEGATIVE BAR 140031-01-CHT
- BOLT C26-06-12U (6)
- NUT D39-06-00B (6)
- STUD-ISOLATED 86233-01-000 (2)
- NUT D34-06-00B (2)
- SCREW G67-10-12U (4)

DETAIL CB

PSLED-2

SWITCH  
DETAIL DG

SWITCHES  
DETAIL DF

SWITCHES  
DETAIL DH

12V BREAKER  
DETAIL GB

LCR-1

SWITCH  
DETAIL CA

RELAY-AWNING  
63912-02-000  
SCREW  
G11-08-08U

32W RELAY-ISOLATION  
63912-02-000 (2)  
SCREW  
G11-08-08U (2)

TO COMPT LAMP

LPGD

IR RECEIVER

TO MAIN TV

DETAIL CB

MAIN CONNECTION  
TO WIRE ASM-CHASSIS

SWITCH  
DETAIL DM

SWITCH  
DETAIL DL

2 PIN HSG  
TO SIDEWALL

ENTERTAINMENT  
CTR COMPL-TV  
000035347 / 317998-01-XXX 1D3 5

TO EXT ENT CTR  
ANTENNA 1D3

2 PIN HSG  
TO WIRE ASM-  
EXT ENT CTR  
COAX (YEL)

TO WIRE ASM-ROOF  
FOR COAX CONNECTIONS  
DETAIL FB

4 PIN HSG  
TO WATER HEATER

ET,EU  
TO REFRIGERATOR

CLAMP  
10495-01-000  
SCREW  
G67-10-12U 6

4 PIN HSG  
TO FURNACE

2 PIN HSG  
TO SIDEWALL

HARNESS-SLIDEOUT  
(REF)

6 PIN HSG  
TO SIDEWALL

DETAIL DK

WIRE ASM-OVHD  
192894-01-000

PSLED-2  
2

HARNESS-SLIDEOUT  
(REF)

ROUTE WIRES  
THRU HOLE

GROMMET  
8386-01-000

7 WASHER-LOCK  
000007554 / 310611-01-000 (2)

JAMB-DOOR

SWITCH/MAGNET-  
STEP, ELECTRIC  
116995-03-000  
SCREW  
G11-06-08U (4)

DETAIL CA

- 7 REMOVE SCREWS FROM MAGNET SWITCH TO INSTALL LOCK WASHER AND RING TERMINALS.
- 6 ROUTE 12V REFRIGERATOR WIRES THROUGH CLAMP TO KEEP OFF OF THE TOP OF THE FURNACE.
- 5 SEE WIRING INSTL-TV/DVD FOR ADDITIONAL INFORMATION.
- 4 WIRE PASSES THROUGH FLOOR IN THIS AREA.
- 3 MOUNT MAGNET USING PILOT HOLES IN SCREEN DOOR FRAME, MOUNT WITH MAGNET TOWARD SWITCH.
- 2 MOUNT SWITCH AND SPACER TO BLOCK ON JAMB, ADJUST HEIGHT TO MATCH MAGNET.

1. AT MINIMUM ALL WIRES TO BE SUPPORTED AND SECURED PER CODE REQUIREMENTS. USE CLAMP 10495 OR 10497 OR WIRE TIE 8343 OR 108046 AND SCREW G67-XX-XXX OR G56-XX-XXX AS APPROPRIATE FOR INSTALLATION.

NOTES:

FOR ELECTRICAL TORQUE SPECIFICATIONS SEE DWG NO. 128783-01-000

FOR ELECTRICAL CALLOUTS SEE DWG NO. 121339-01-000

- 32W GENERATOR-START,AUTO SYSTEM
- 1D3 ENTERTAIN CENTR/EXT TV-DVD
- 265 CODES/STANDARDS-CSA/CMVSS
- 1B1 CODES/STANDARDS USA

DESCRIPTION:		1B1 265	
<b>WIRING INSTL-BODY, 12V</b>			
SHEET:	ITEM/PART NO.:	REV:	
3 OF 8	000002440 / 31200501000		

D

C

B

A

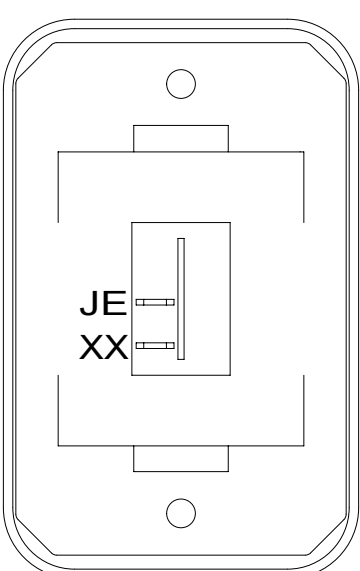

SWITCH-ROCKER  
135740-01-CHT  
SWITCH-BASE  
135741-01-CHT  
SWITCH-BEZEL  
135742-01-CHT  
SCREW  
G11-08-08U (2)

DETAIL DA

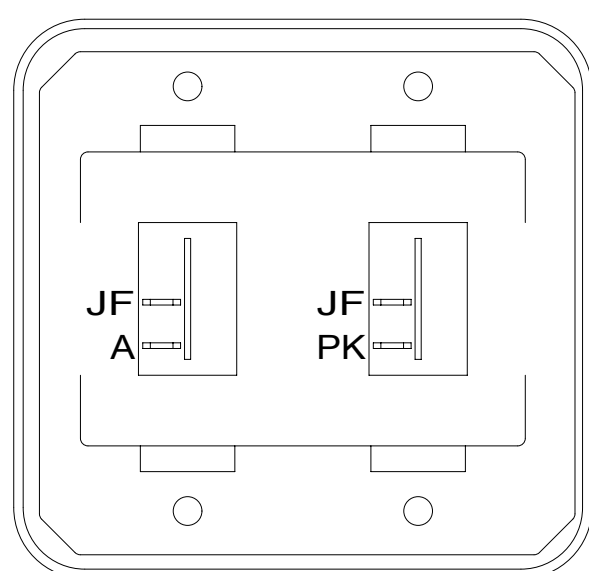

SWITCH-ROCKER  
135740-01-CHT (2)  
SWITCH-BASE  
135741-02-CHT  
SWITCH-BEZEL  
135742-02-CHT  
SCREW  
G11-08-08U (4)

DETAIL DF

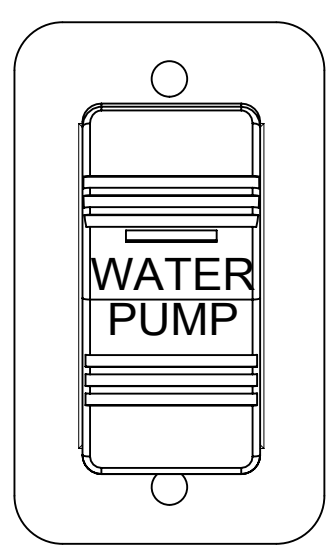

SWITCH-PUMP  
108357-15-000  
ACTUATOR  
108356-23-CHT  
PLATE  
98351-07-CHT  
SCREW  
G11-06-10U (2)

DETAIL DM

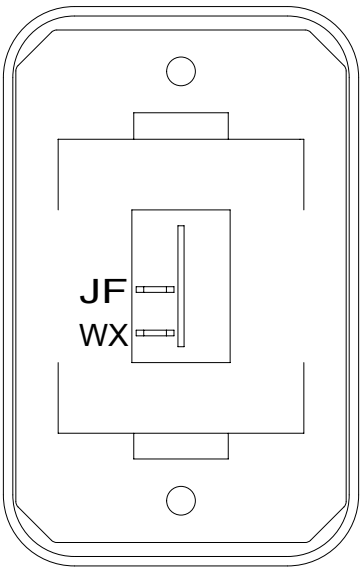

SWITCH-ROCKER  
135740-01-CHT  
SWITCH-BASE  
135741-01-CHT  
SWITCH-BEZEL  
135742-01-CHT  
SCREW  
G11-08-08U (2)

DETAIL DB

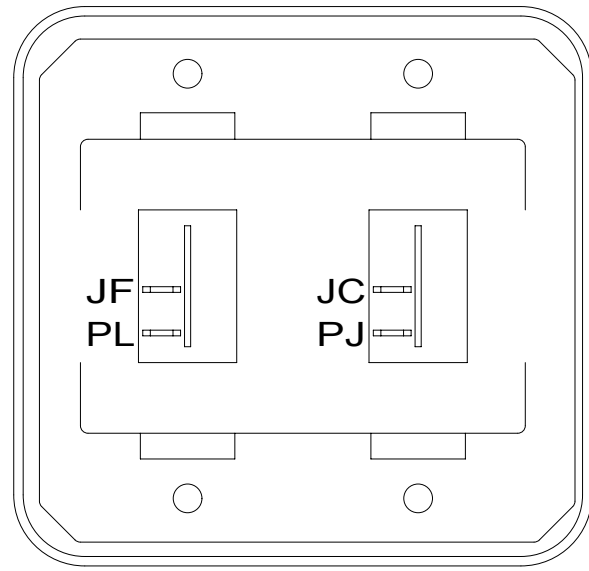

SWITCH-ROCKER  
135740-01-CHT (2)  
SWITCH-BASE  
135741-02-CHT  
SWITCH-BEZEL  
135742-02-CHT  
SCREW  
G11-08-08U (4)

DETAIL DG

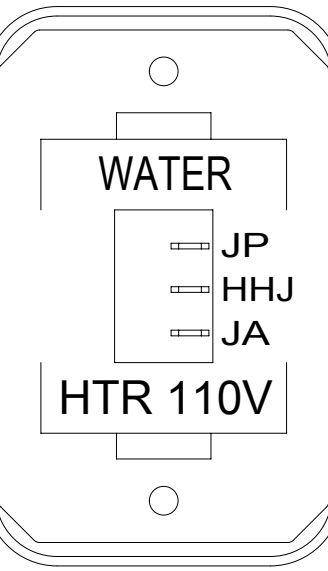

SWITCH-ROCKER  
135740-06-CHT  
SWITCH-BASE  
135741-01-CHT  
SWITCH-BEZEL  
135742-35-CHT  
SCREW  
G11-08-08U (2)

DETAIL DP

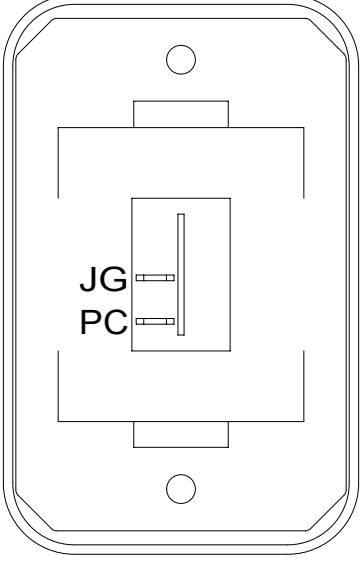

SWITCH-ROCKER  
135740-01-CHT  
SWITCH-BASE  
135741-01-CHT  
SWITCH-BEZEL  
135742-01-CHT  
SCREW  
G11-08-08U (2)

DETAIL DC

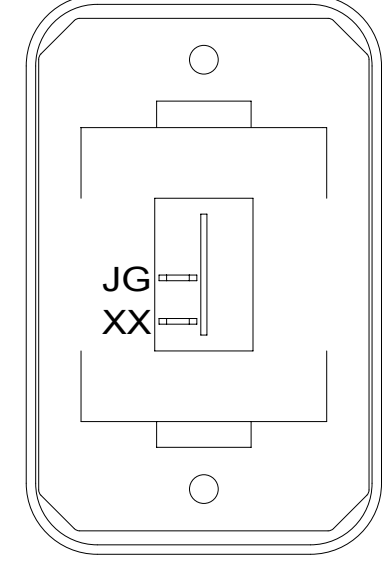

SWITCH-ROCKER  
135740-01-CHT  
SWITCH-BASE  
135741-01-CHT  
SWITCH-BEZEL  
135742-01-CHT  
SCREW  
G11-08-08U (2)

DETAIL DJ

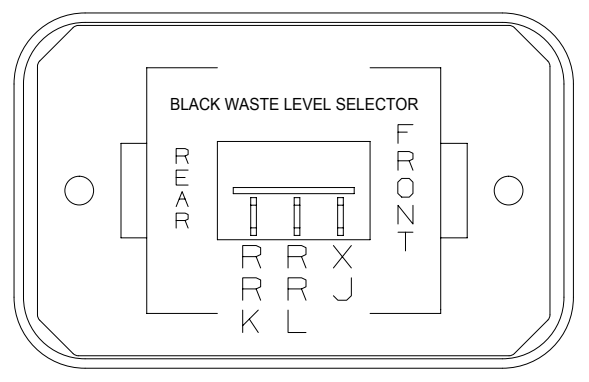

SWITCH-ROCKER  
135740-02-CHT  
SWITCH-BASE  
135741-01-CHT  
SWITCH-BEZEL  
135742-61-CHT  
SCREW  
G11-08-08U (2)

DETAIL DR

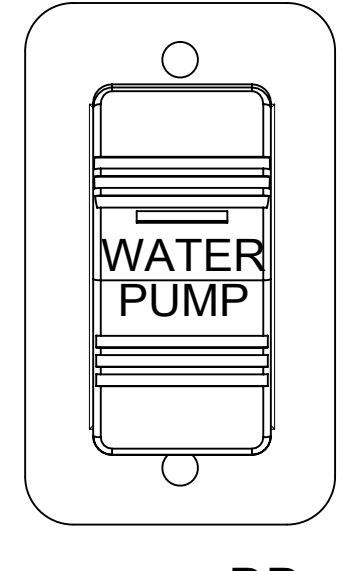

SWITCH-PUMP  
108357-15-000  
ACTUATOR  
108356-23-CHT  
PLATE  
98351-07-CHT  
SCREW  
G11-06-10U (2)

DETAIL DD

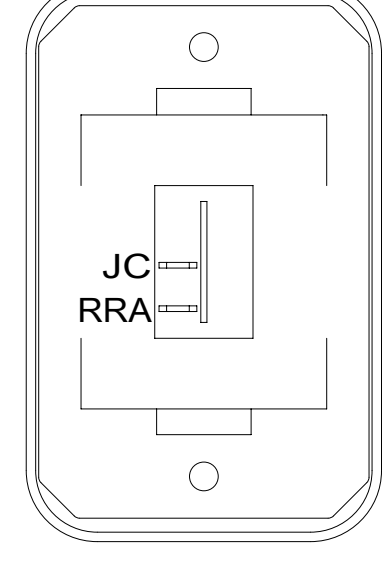

SWITCH-ROCKER  
135740-01-CHT  
SWITCH-BASE  
135741-01-CHT  
SWITCH-BEZEL  
135742-01-CHT  
SCREW  
G11-08-08U (2)

DETAIL DK

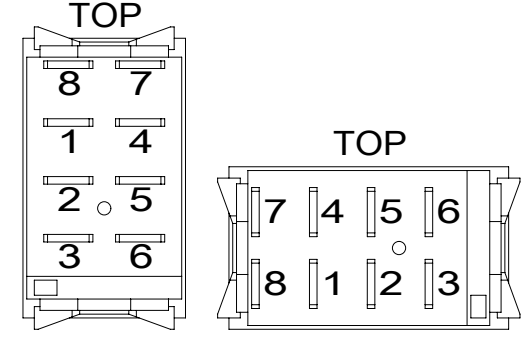

DETAIL DS

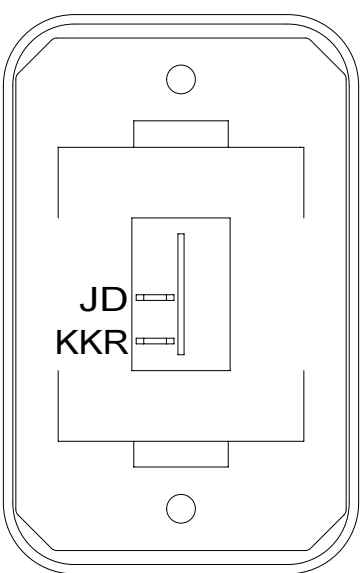

SWITCH-ROCKER  
135740-01-CHT  
SWITCH-BASE  
135741-01-CHT  
SWITCH-BEZEL  
135742-01-CHT  
SCREW  
G11-08-08U (2)

DETAIL DE

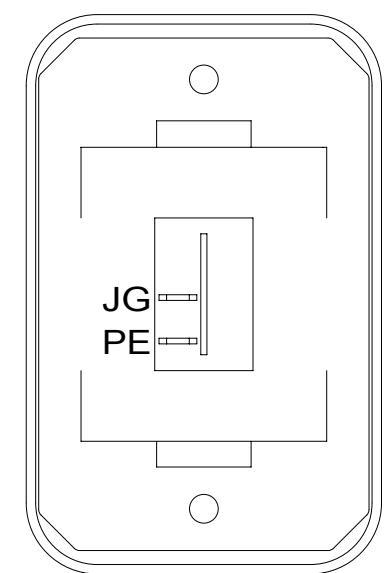

SWITCH-ROCKER  
135740-01-CHT  
SWITCH-BASE  
135741-01-CHT  
SWITCH-BEZEL  
135742-01-CHT  
SCREW  
G11-08-08U (2)

DETAIL DL

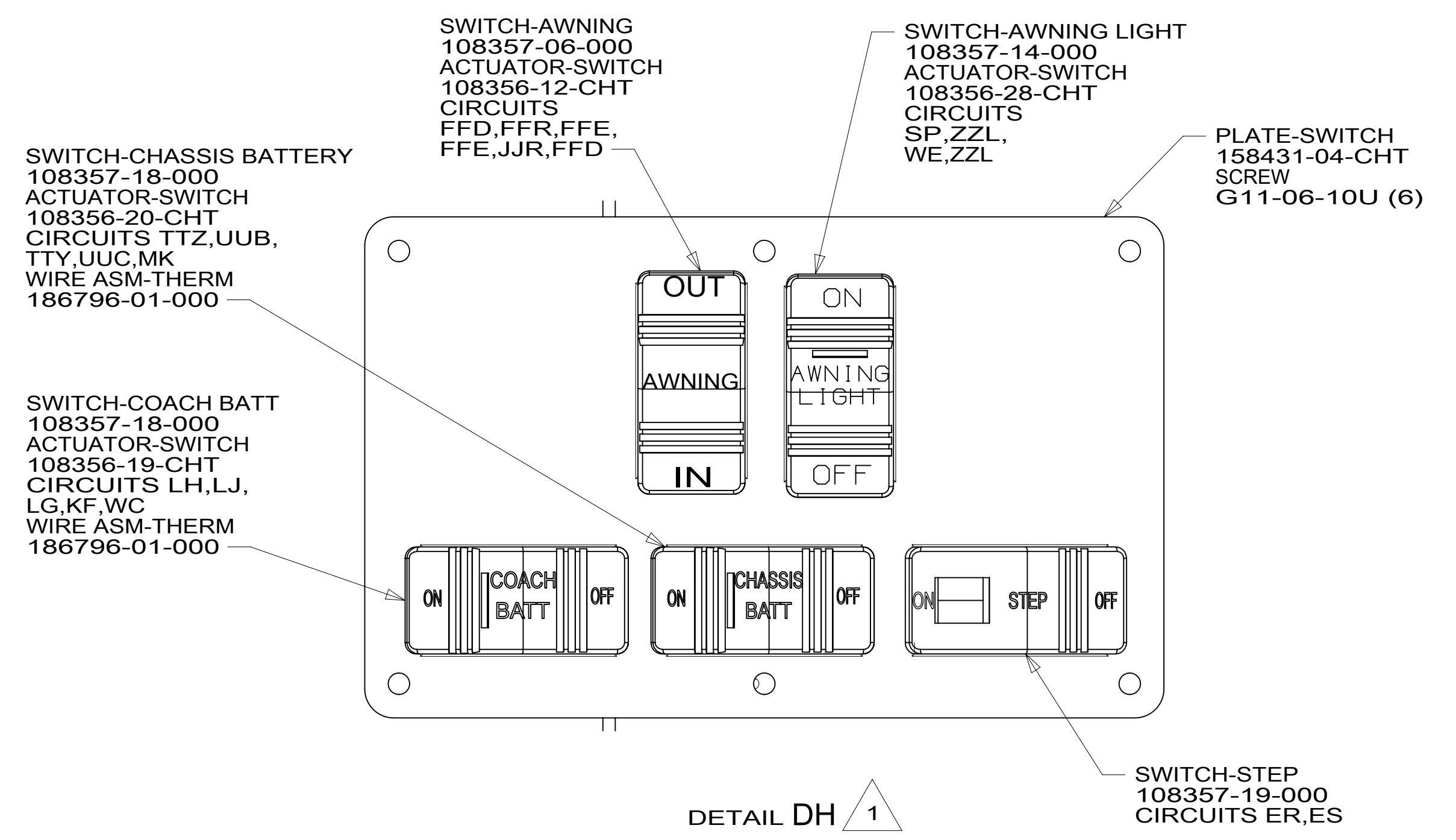

DETAIL DH 1

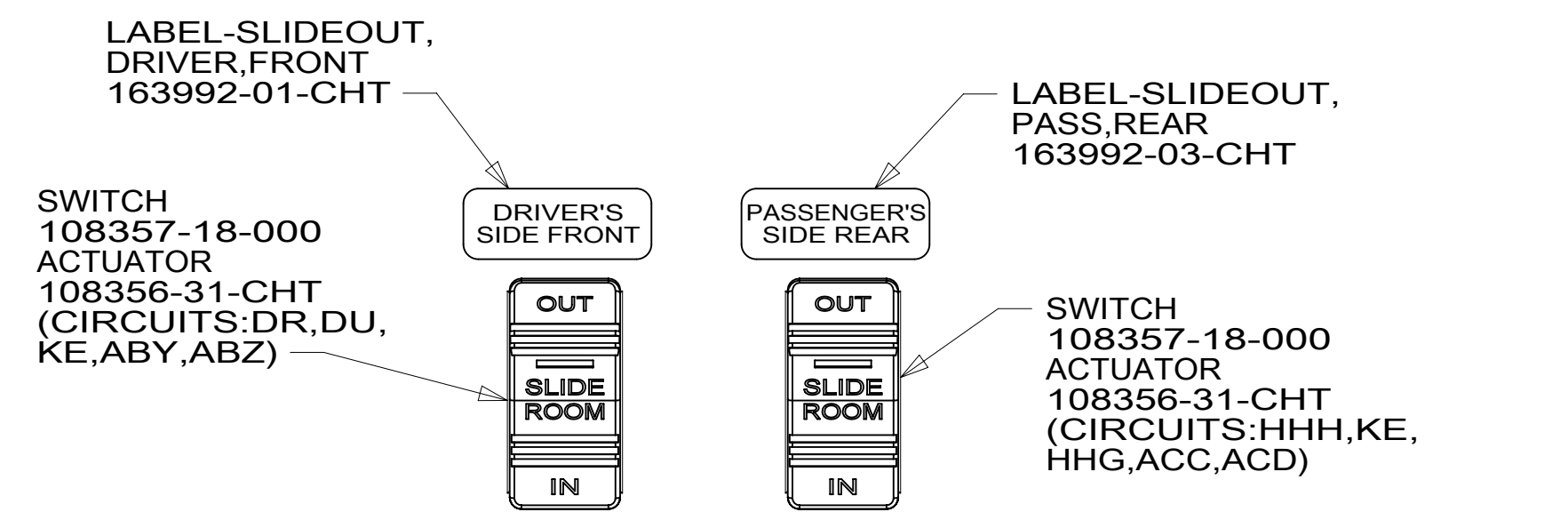

WARNING CRUSH HAZARD. Keep people and objects clear of the inside and the outside of the slideout room when operating. Failure to comply could result in death or serious injury.

LABEL-WARNING,SLIDEOUT  
116549-01-000

DETAIL DN

NOTES:  
1 FOR SWITCH ORIENTATION SEE DETAIL DS

FOR ELECTRICAL  
TORQUE  
SPECIFICATIONS  
SEE DWG NO.  
128783-01-000

FOR  
ELECTRICAL  
CALLOUTS  
SEE DWG NO.  
121339-01-000

265 CODES/STANDARDS-CSA/CMVSS  
1B1 CODES/STANDARDS USA

DESCRIPTION:	1B1 265	
WIRING INSTL-BODY, 12V		
SHEET:	ITEM/PART NO.:	REV
4 OF 8	000002440 / 31200501000	

8 7 6 5 4 3 2 1

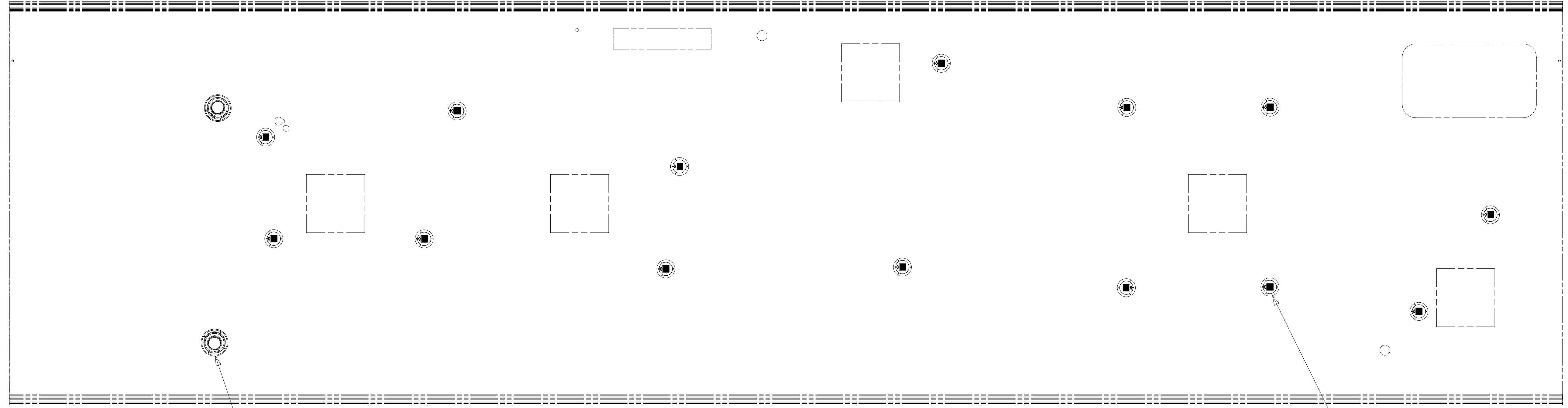

SPEAKER-ROUND,CEILING  
 180783-01-CHT (2)  
 SCREW  
 000G11-08-12U (8)

LO1-3

PRLED-4  
 14

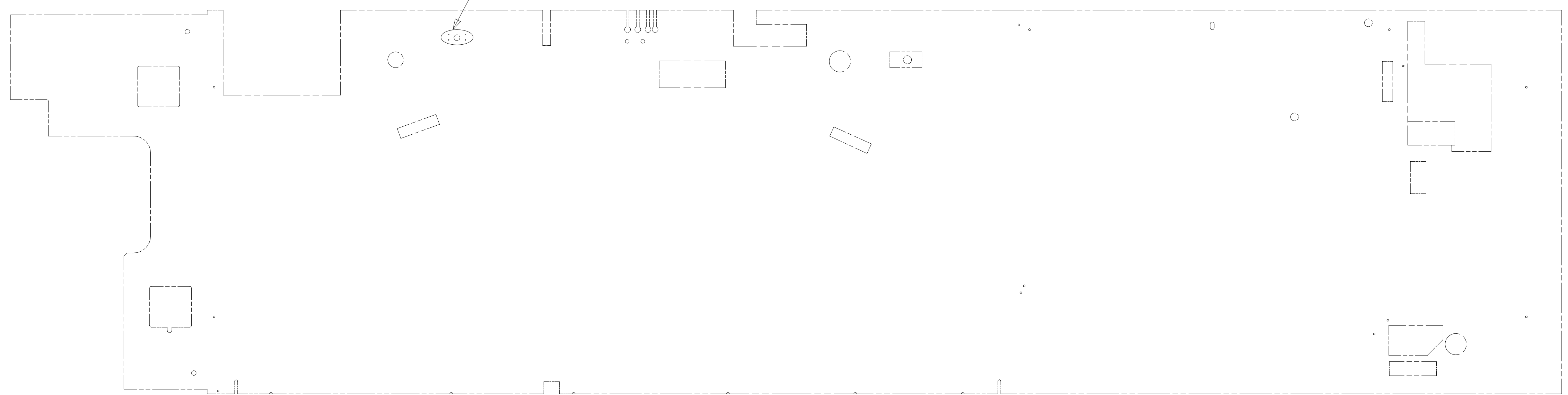

D  
C  
B  
A

D  
C  
B  
A

8 7 6 5 4 3 2 1 14-Sep-2017

265 CODES/STANDARDS-CSA/CMVSS  
 1B1 CODES/STANDARDS USA

FOR ELECTRICAL  
 TORQUE  
 SPECIFICATIONS  
 SEE DWG NO.  
 128783-01-000

FOR  
 ELECTRICAL  
 CALLOUTS  
 SEE DWG NO.  
 121339-01-000

1B1 265  
 DESCRIPTION:  
**WIRING INSTL-BODY, 12V**  
 SHEET: 5 OF 8 ITEM/PART NO: 000002440 / 31200501000 REV

8 7 6 5 4 3 2 1

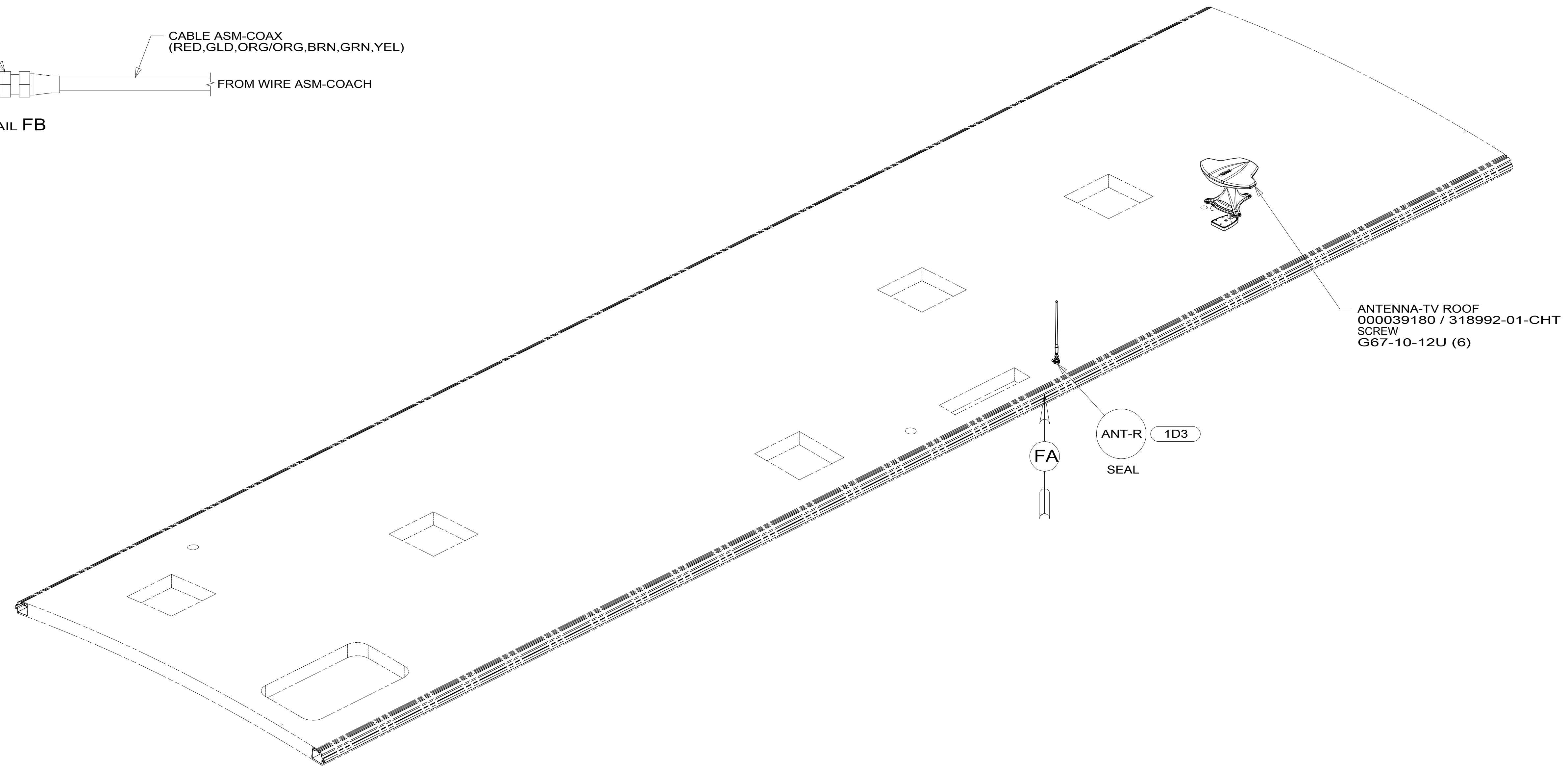
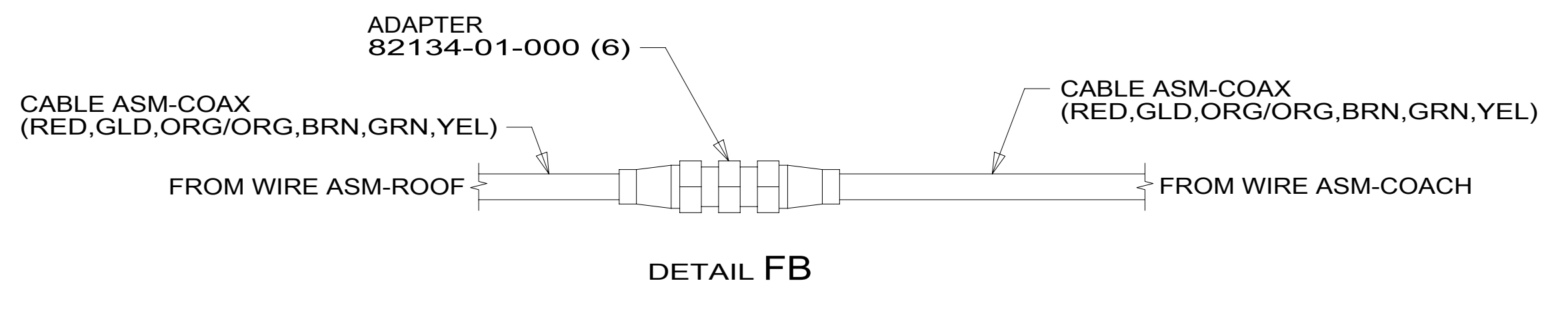
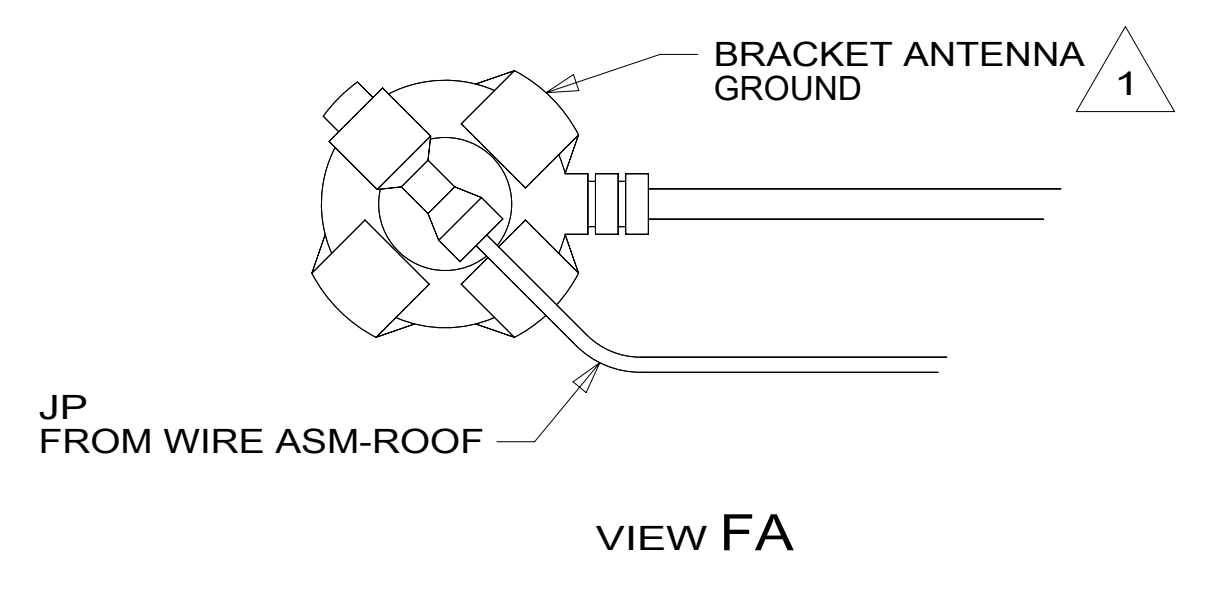

NOTES:

1 WRAP LEGS AROUND ANTENNA BASE.

FOR ELECTRICAL TORQUE SPECIFICATIONS SEE DWG NO. 128783-01-000

FOR ELECTRICAL CALLOUTS SEE DWG NO. 121339-01-000

- 1D3 ENTERTAIN CENTR/EXT TV-DVD
- 265 CODES/STANDARDS-CSA/CMVSS
- 1B1 CODES/STANDARDS USA

DESCRIPTION: <b>WIRING INSTL-BODY, 12V</b>		
SHEET: 6 OF 8	ITEM/PART NO: 000002440 / 31200501000	REV

8 7 6 5 4 3 2 1 14-Sep-2017

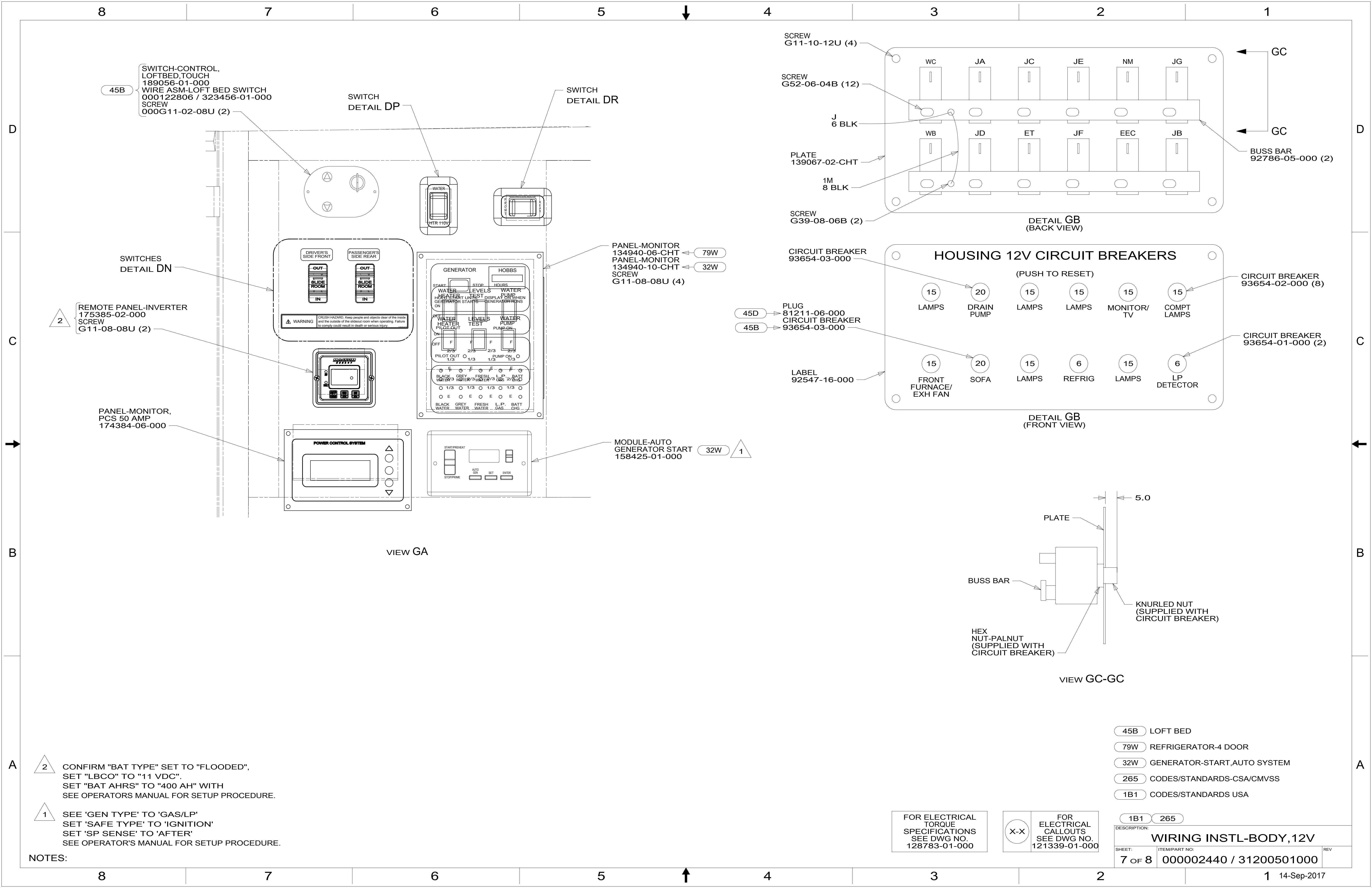

SWITCH-CONTROL, LOFTBED, TOUCH  
189056-01-000  
WIRE ASM-LOFT BED SWITCH  
000122806 / 323456-01-000  
SCREW  
000G11-02-08U (2)

SWITCH  
DETAIL DP

SWITCH  
DETAIL DR

SCREW  
G11-10-12U (4)

SCREW  
G52-06-04B (12)

J  
6 BLK

PLATE  
139067-02-CHT

1M  
8 BLK

SCREW  
G39-08-06B (2)

DETAIL GB  
(BACK VIEW)

SWITCHES  
DETAIL DN

REMOTE PANEL-INVERTER  
175385-02-000  
SCREW  
G11-08-08U (2)

PANEL-MONITOR,  
PCS 50 AMP  
174384-06-000

PANEL-MONITOR  
134940-06-CHT 79W  
PANEL-MONITOR  
134940-10-CHT 32W  
SCREW  
G11-08-08U (4)

CIRCUIT BREAKER  
93654-03-000

HOUSING 12V CIRCUIT BREAKERS

(PUSH TO RESET)

PLUG  
81211-06-000  
CIRCUIT BREAKER  
93654-03-000

LABEL  
92547-16-000

DETAIL GB  
(FRONT VIEW)

MODULE-AUTO  
GENERATOR START  
158425-01-000 32W 1

VIEW GA

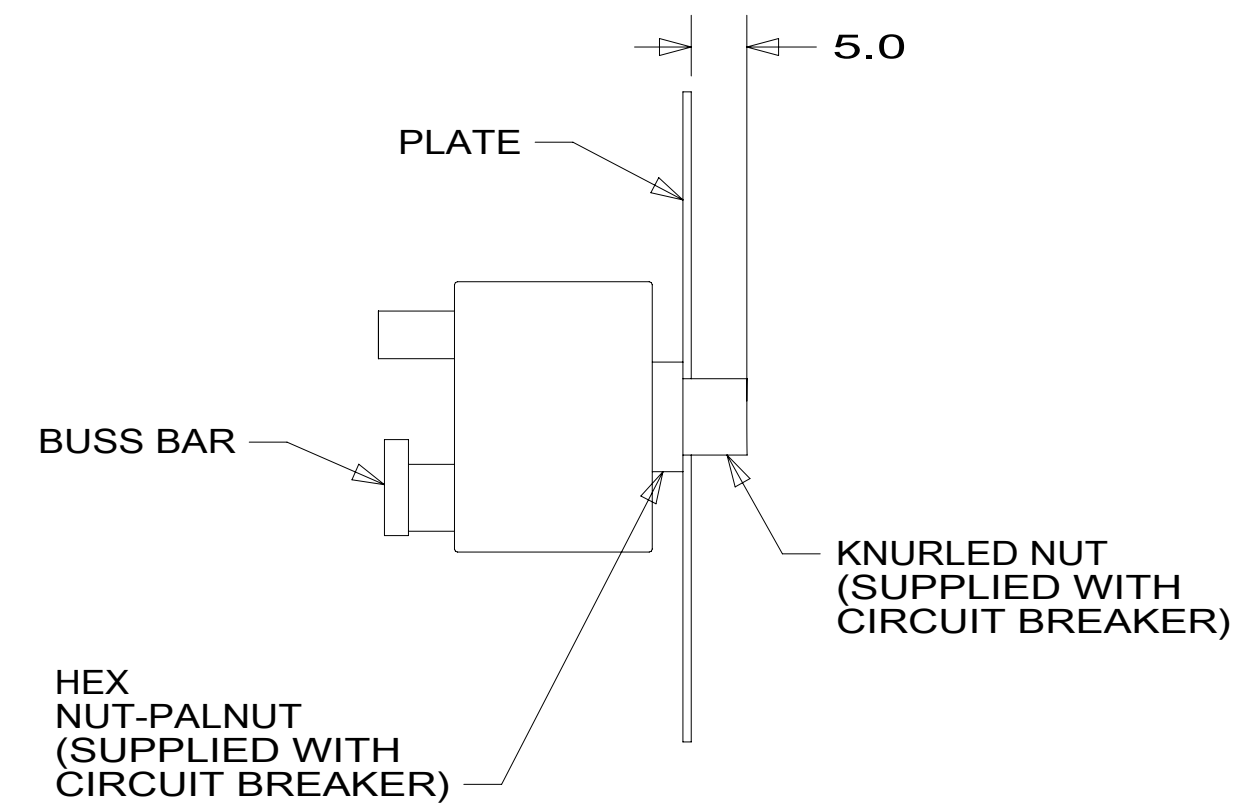

VIEW GC-GC

2 CONFIRM "BAT TYPE" SET TO "FLOODED",  
SET "LBCO" TO "11 VDC".  
SET "BAT AHRS" TO "400 AH" WITH  
SEE OPERATORS MANUAL FOR SETUP PROCEDURE.

1 SEE 'GEN TYPE' TO 'GAS/LP'  
SET 'SAFE TYPE' TO 'IGNITION'  
SET 'SP SENSE' TO 'AFTER'  
SEE OPERATOR'S MANUAL FOR SETUP PROCEDURE.

NOTES:

- 45B LOFT BED
- 79W REFRIGERATOR-4 DOOR
- 32W GENERATOR-START,AUTO SYSTEM
- 265 CODES/STANDARDS-CSA/CMVSS
- 1B1 CODES/STANDARDS USA

FOR ELECTRICAL  
TORQUE  
SPECIFICATIONS  
SEE DWG NO.  
128783-01-000

FOR  
ELECTRICAL  
CALLOUTS  
SEE DWG NO.  
121339-01-000

DESCRIPTION:	1B1 265	
<b>WIRING INSTL-BODY, 12V</b>		
SHEET:	ITEM/PART NO:	REV
7 OF 8	000002440 / 31200501000	

8 7 6 5 4 3 2 1

D

D

C

C

B

B

A

A

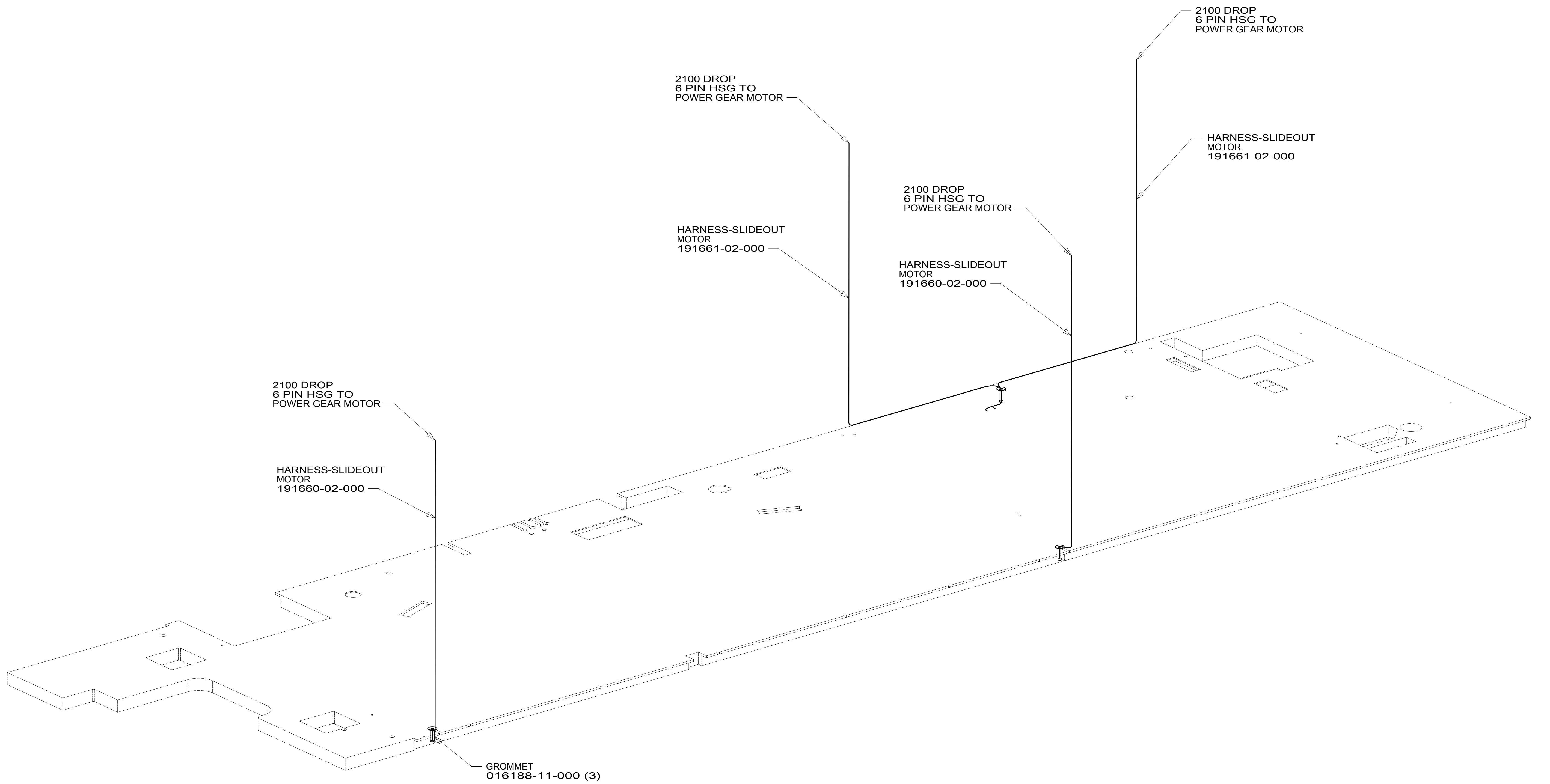

265 CODES/STANDARDS-CSA/CMVSS  
 1B1 CODES/STANDARDS USA

FOR ELECTRICAL  
 TORQUE  
 SPECIFICATIONS  
 SEE DWG NO.  
 128783-01-000

FOR  
 ELECTRICAL  
 CALLOUTS  
 SEE DWG NO.  
 121339-01-000

1B1 265	
DESCRIPTION: <b>WIRING INSTL-BODY, 12V</b>	
SHEET: <b>8 OF 8</b>	ITEM/PART NO: <b>000002440 / 31200501000</b>
REV	

8 7 6 5 4 3 2 1 14-Sep-2017