

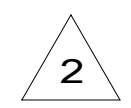



DRAWING NO.	SHEET
193109-01	1,2
193109-02	1,3

RELEASE	REV/DATE	DWG NO	193109
REV ZONE	A	REVISION RECORD	DATE DFT-ORIG

	600-SERIES
CABLE ASM-STARTER (RED)	185087-01-038
CABLE ASM-COACH BATTERY (YEL)	141415-52-010
CABLE ASM-COACH BATTERY GND (BLK)	133566-17-022
CABLE ASM-GENERATOR (GRN)	141415-42-030
CABLE ASM-GENERATOR GND (BLK)	133566-17-014
CABLE ASM-JUMPER,POS	141415-52-004
CABLE ASM-JUMPER,NEG	133566-12-004

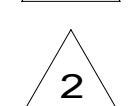
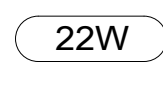
-  2
-  2
-  2
-  22W
-  22W

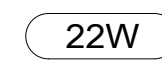
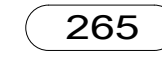
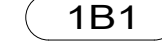
-  22W BATTERY-SECOND
-  265 CODES/STANDARDS-CSA/CMVSS
-  1B1 CODES/STANDARDS USA

-  1B1
-  265

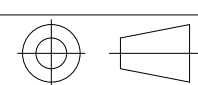

DFT-ORIG	ORIG. DATE
CHKR	ALL DIMENSIONS ARE IN MILLIMETERS
P.E.	
M.E.	FIRST USED
DSNR	16 600-SERIES
UNSPECIFIED TOLERANCES ARE:	
WHOLE DIM (X) :	MATERIAL:
ONE-PLACE (X.X) :	
TWO-PLACE (X.XX) :	
ANGLE :	
THIRD ANGLE PROJECTION	
DO NOT SCALE DRAWING	REFER TO ES0018 FOR FASTENER TIGHTENING GUIDELINES
TITLE: BATTERY INSTL	
SHEET 1 OF 3	PART NO 193109

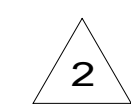
 2 ROUTING OF CABLE SHOWN ON WIRING INSTL-CHASSIS ONLY.
 1. SEE WIRING INSTL-CHASSIS FOR ADDITIONAL INFORMATION FOR ROUTING CABLES.

FOR ELECTRICAL TORQUE SPECIFICATIONS SEE DWG NO. 128783-01-000

 FOR ELECTRICAL CALLOUTS SEE DWG NO. 121339-01-000

193109

BATTERY-12V,AGM
174923-01-000

CABLE ASM-COACH
BATTERY POS
(YEL)

CABLE ASM-COACH
BATTERY POS
(YEL)

CABLE ASM-COACH
BATTERY GND
(BLK)

TIE DOWN ASM-BATTERY
160014-03-CHT
BOLT
51387-06-000 (2)
NUT
D39-05-00U (2)
WASHER-SPEEDNUT
184541-01-CHT (2)

CABLE ASM-COACH
BATTERY GND
(BLK)

VIEW BA

1. SEE WIRING INSTL-CHASSIS FOR ADDITIONAL INFORMATION FOR ROUTING CABLES.

NOTES:

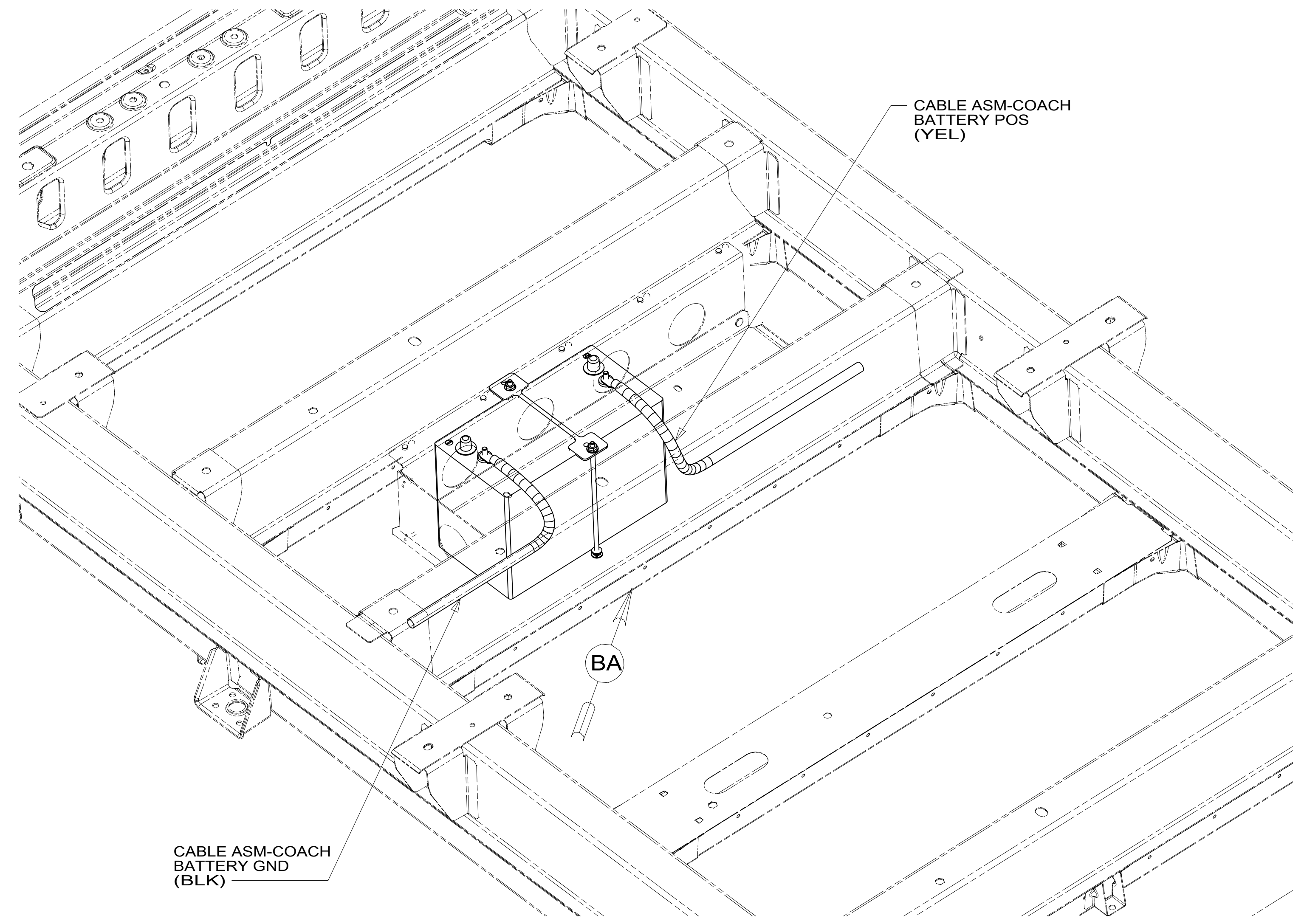

12X BATTERY-ONE

265 CODES/STANDARDS-CSA/CMVSS

1B1 CODES/STANDARDS USA

1B1 265 12X

FIRST USED
16 600-SER

DO NOT SCALE DRAWING

TITLE:
BATTERY INSTL

SHEET 2 PART NO **193109** REV

FOR ELECTRICAL
TORQUE
SPECIFICATIONS
SEE DWG NO.
128783-01-000

X-X
FOR
ELECTRICAL
CALLOUTS
SEE DWG NO.
121339-01-000

193109

8

7

6

5

4

3

2

1

D

D

C

C

B

B

A

A

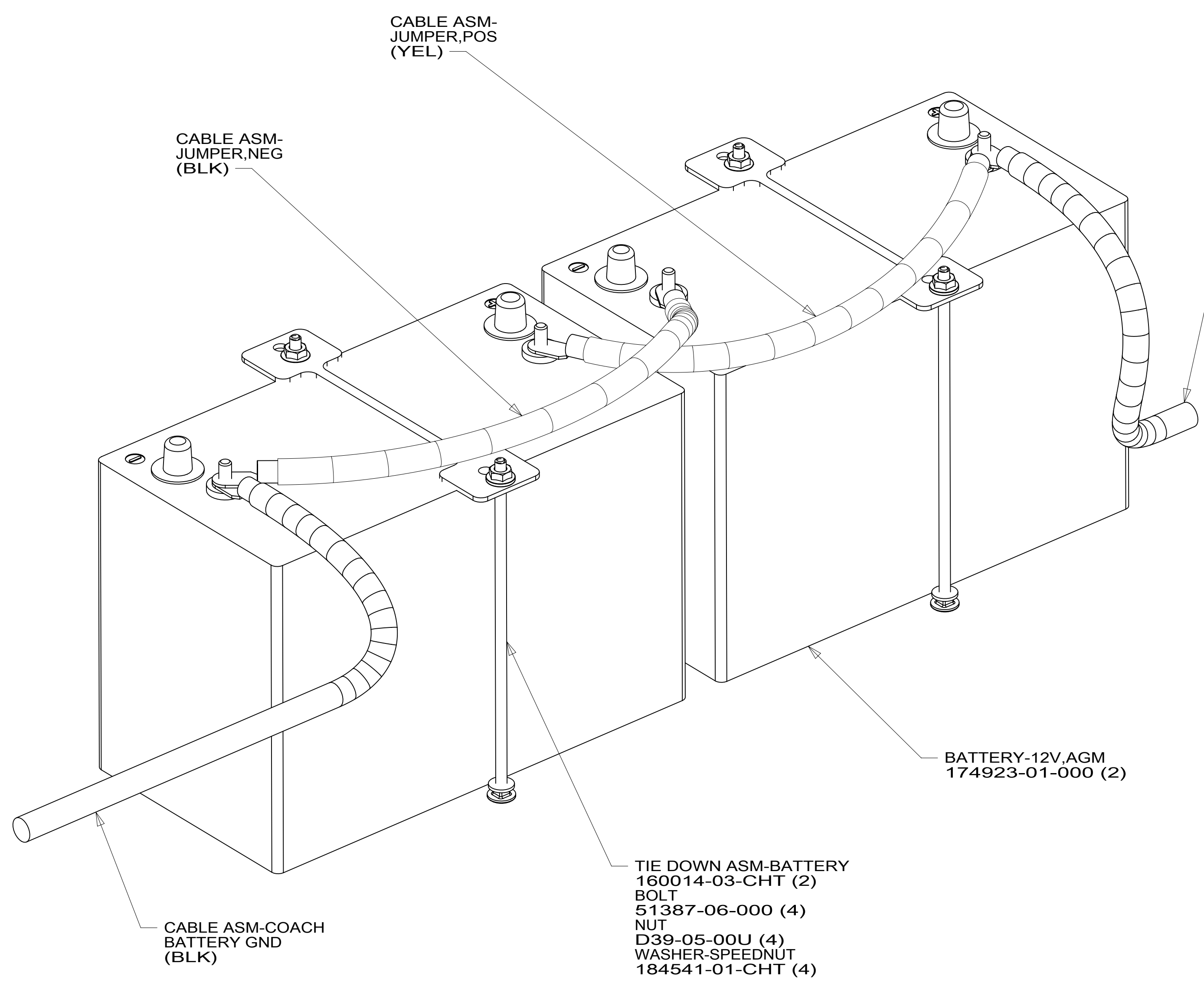

VIEW CA

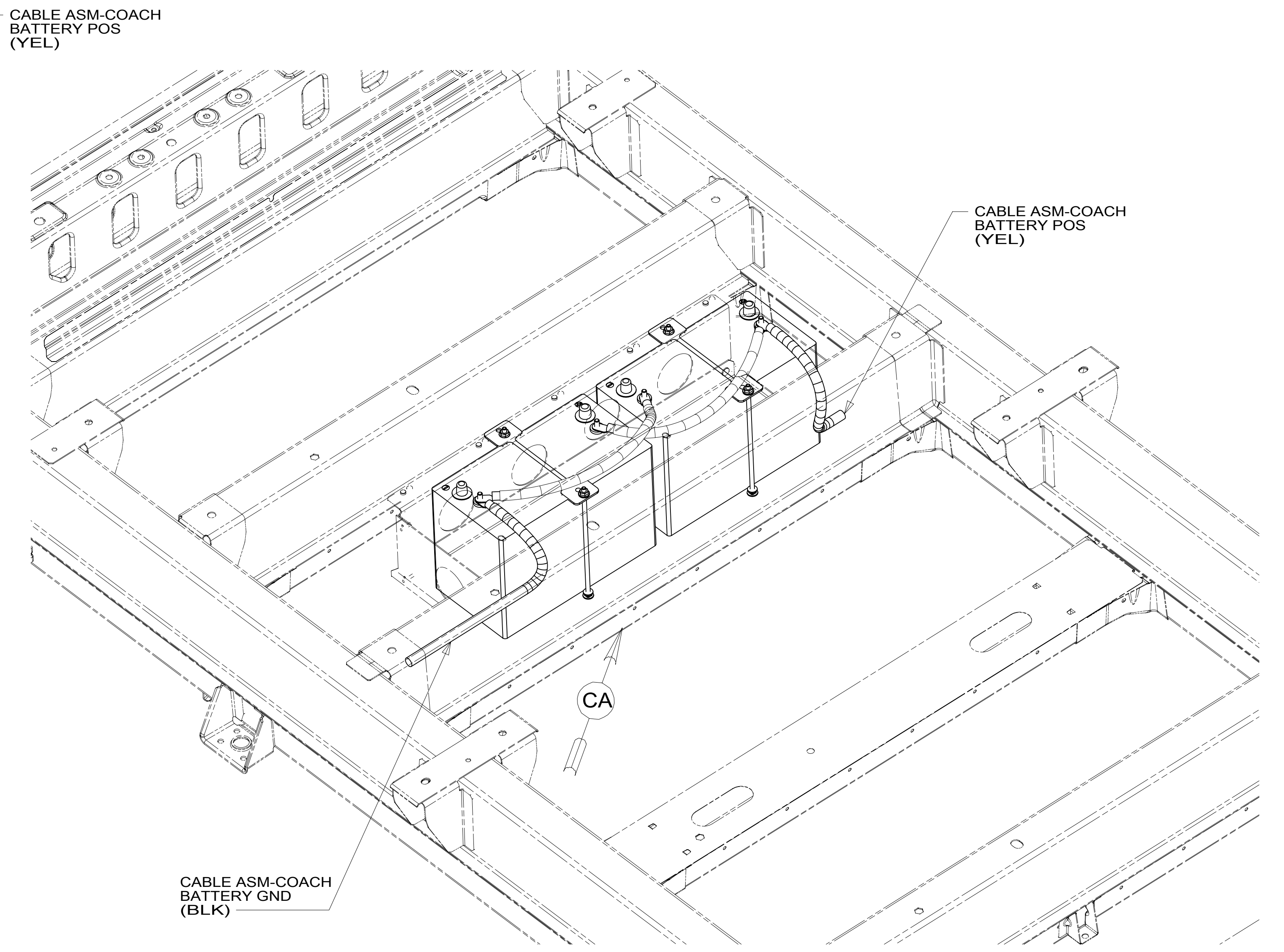

1. SEE WIRING INSTL-CHASSIS FOR ADDITIONAL INFORMATION FOR ROUTING CABLES.

NOTES:

- 22W BATTERY-SECOND
- 265 CODES/STANDARDS-CSA/CMVSS
- 1B1 CODES/STANDARDS USA

1B1 265 22W

FIRST USED 16 600-SER

DO NOT SCALE DRAWING

TITLE: BATTERY INSTL

SHEET 3 PART NO 193109 REV

FOR ELECTRICAL TORQUE SPECIFICATIONS SEE DWG NO. 128783-01-000

FOR ELECTRICAL CALLOUTS SEE DWG NO. 121339-01-000

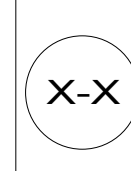

193109

8

7

6

5

4

3

2

1

10-Jul-2015