



DANGER

Danger of electrical shock, burns or death. Always remove all power sources before attempting any repair, service or diagnostic work. Power can be present from shore power, generator, inverter or battery. All power sources must be disabled and secured before performing any service.



CAUTION

If you lack the skills, tools or equipment to perform diagnostic or repair work leave such work to an authorized Winnebago Industries dealer or other qualified shop.

DRAWING NO.	MODEL	SHEETS
189259-01	J32D	1,8,9,10,11
189259-02	J37F	1,7,8,9,11
189259-03	J35P	1,2,3,11
189259-04	J38Q	1,4,5,6,11

		J32D	J37F	J35P	J38Q
CABLE ASM-CHASSIS GND EXT (BLK)	16Z 16L 16A	133566-12-013	133567-12-045	133566-12-031	133567-12-013
CHASSIS BATTERY DISCONNECT RETURN (PUR)	16Z 16L 16A	141416-12-045	141416-12-046	141415-12-035	141416-12-049
CABLE ASM-CHASSIS BATTERY DISCONNECT SUPPLY (RED)	16Z 16L 16A	141416-32-041	141416-32-015	141415-32-011	141416-32-046
CABLE ASM-COACH BATTERY (YEL)		141416-52-020	141416-52-028	141416-52-017	141416-52-015
CABLE ASM-COACH BATTERY GND (BLK)		133567-12-008	133567-12-028	133567-12-006	133567-12-038
CABLE ASM-STARTER (RED)		141416-32-010	141416-32-044	141416-32-033	141416-32-010
CABLE ASM-GENERATOR (GRN)	321 52P	141415-42-073	141415-42-073	141415-42-079	141415-42-073
WIRE ASM-INVERTER	401	N/A	N/A	154845-02-012	N/A
LEVELING SYSTEM POWER CABLE (BLU)	60M	141415-29-031	141415-29-072	141415-29-058	141415-29-071
LEVELING SYSTEM GND CABLE (BLK)	60M	133566-11-008	133566-11-008	133566-11-008	133566-11-008
CABLE ASM (ORG) FROM COACH BATTERY TO INVERTER FUSE		175207-62-006	175207-62-006		175207-62-012
CABLE ASM (ORG) FROM INVERTER FUSE TO INVERTER BATT DISCONNECT		175207-62-024	175207-62-028		175207-62-012
CABLE ASM (ORG) FROM BATTERY DISCONNECT TO POSITIVE POST ON INVERTER		175207-62-008	175207-62-008		175207-62-008
CABLE ASM (BLK) FROM COACH BATTERY TO INVERTER NEGATIVE TERMINAL		175211-01-027	175211-01-030		175211-01-023
CABLE ASM-TEMPERATURE		175385-03-000			175385-03-000
CABLE ASM (YEL) JUMPER BETWEEN POSITIVE POSTS ON COACH BATTERY		141417-52-004 141417-51-002 (2) 15L	141417-52-004 141417-51-002 (2) 15L		141417-52-004 141417-51-002 (2)
CABLE ASM (BLK) JUMPER BETWEEN NEGATIVE POSTS ON COACH BATTERY		133568-12-004 133568-11-002 (2) 15L	133568-12-004 133568-11-002 (2) 15L		133568-12-004 133568-11-002 (2)
CABLE ASM-CHASSIS BATTERY FUSE (RED)		141415-32-003	141415-32-003	141415-32-003	141415-32-005
CABLE ASM-COACH BATTERY FUSE (YEL)		141416-52-003	141416-52-003	141416-52-006	141416-52-003

- RESIDENTIAL REFRIGERATOR PKG
- FORD 26,000#-22.5 AL WHL
- GEN-5.5KW ONAN-GAS-MARQ GOLD
- GENERATOR PREP KIT
- HYDRAULIC LEVEL JACKS-AUTO
- INVERTER-DC/AC, 1000 WATT
- FORD 24,000#-22.5 ALUM WHEEL
- FORD 22,000#-22.5 AL WHL
- CODES/STANDARDS-CSA/CMVSS
- CODES/STANDARDS USA

WINNEBAGO COPYRIGHT 2014 WINNEBAGO INDUSTRIES, INC.

UNSPECIFIED TOLERANCES ARE:
 WHOLE DIM (X) : 3
 ONE-PLACE (X.X) : 1.5
 TWO-PLACE (X.XX) : 0.50
 ANGLE : 1°

THIRD ANGLE PROJECTION

DO NOT SCALE DRAWING REFER TO ES0018 FOR FASTENER TIGHTENING GUIDELINES

TITLE: **BATTERY INSTL,FD**

SHEET 1 OF 11 PART NO. 189259 REV

REF: 1 24-Feb-2015

CABLE ASM-TEMPERATURE IS PART OF WIRE ASM-CHASSIS.

BATTERY CABLES MUST BE INSTALLED TO STARTER MOTOR BEFORE ENGINE WIRING HARNESS AND ROUTED IN SUCH A MANNER AS TO PREVENT ANY POSSIBLE DEGRADATION FROM THE EXHUAST SYSTEM.

FOR ELECTRICAL TORQUE SPECIFICATIONS SEE DWG NO. 128783-01-000

FOR ELECTRICAL CALLOUTS SEE DWG NO. 121339-01-000

189259

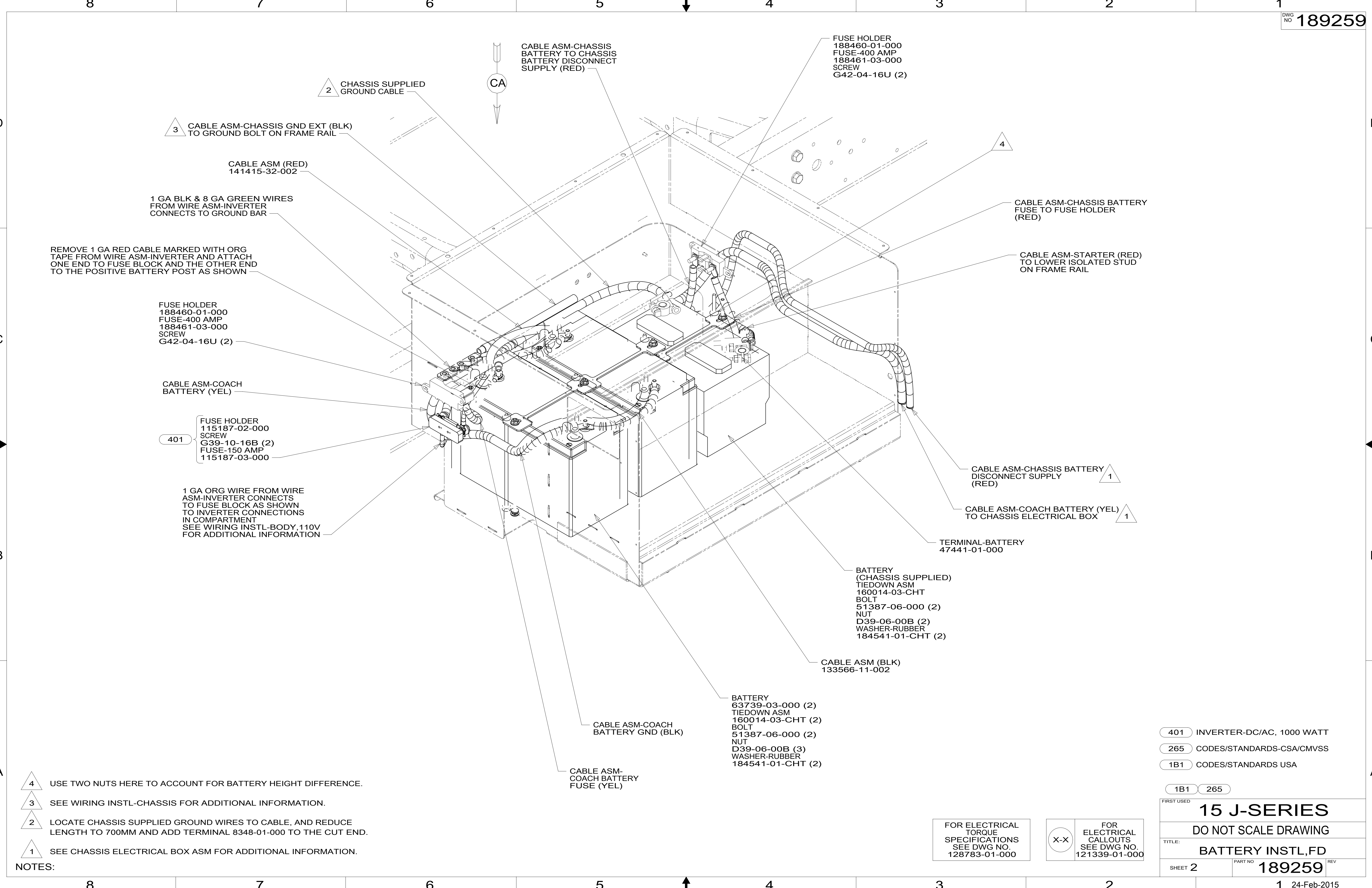

- NOTES:
- 4** USE TWO NUTS HERE TO ACCOUNT FOR BATTERY HEIGHT DIFFERENCE.
 - 3** SEE WIRING INSTL-CHASSIS FOR ADDITIONAL INFORMATION.
 - 2** LOCATE CHASSIS SUPPLIED GROUND WIRES TO CABLE, AND REDUCE LENGTH TO 700MM AND ADD TERMINAL 8348-01-000 TO THE CUT END.
 - 1** SEE CHASSIS ELECTRICAL BOX ASM FOR ADDITIONAL INFORMATION.

- 401** INVERTER-DC/AC, 1000 WATT
- 265** CODES/STANDARDS-CSA/CMVSS
- 1B1** CODES/STANDARDS USA

FIRST USED	
15 J-SERIES	
DO NOT SCALE DRAWING	
TITLE: BATTERY INSTL,FD	
SHEET 2	PART NO 189259 REV

FOR ELECTRICAL TORQUE SPECIFICATIONS SEE DWG NO. 128783-01-000

FOR ELECTRICAL CALLOUTS SEE DWG NO. 121339-01-000

189259

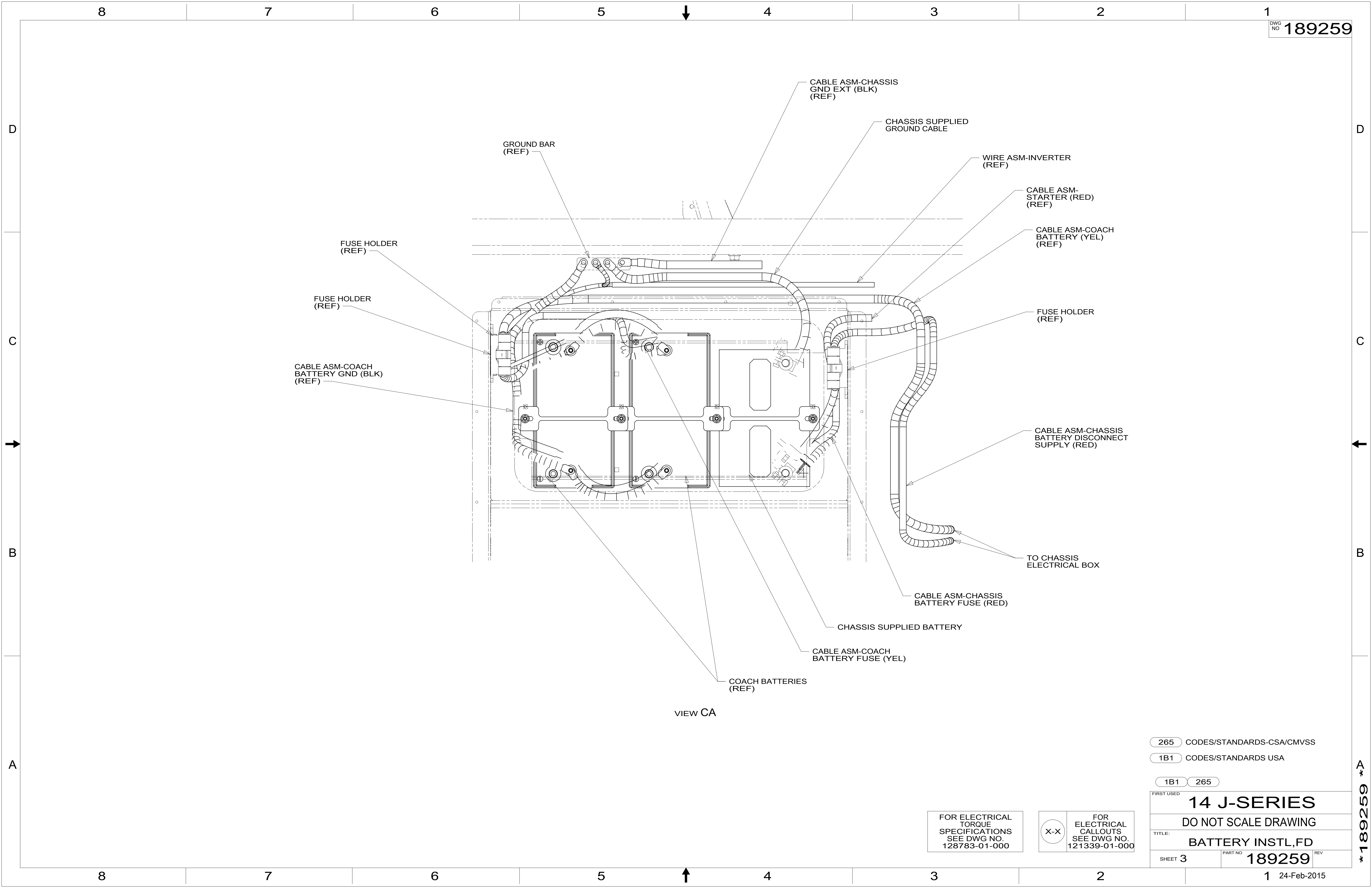

VIEW CA

265 CODES/STANDARDS-CSA/CMVSS

1B1 CODES/STANDARDS USA

1B1 265

FIRST USED **14 J-SERIES**

DO NOT SCALE DRAWING

TITLE: **BATTERY INSTL,FD**

SHEET 3 PART NO **189259** REV

FOR ELECTRICAL TORQUE SPECIFICATIONS SEE DWG NO. 128783-01-000

FOR ELECTRICAL CALLOUTS SEE DWG NO. 121339-01-000

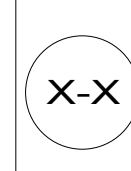

189259

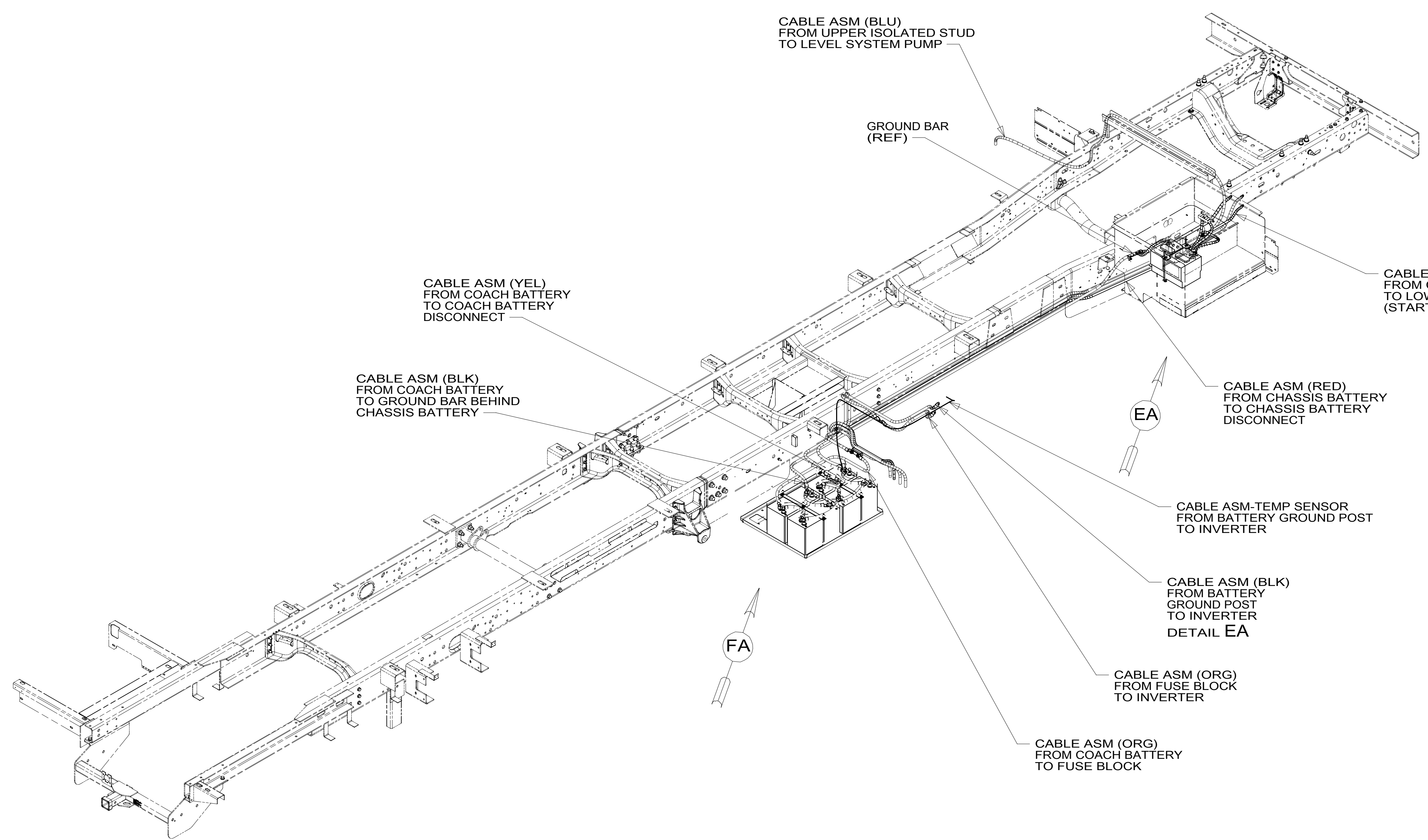

- 265 CODES/STANDARDS-CSA/CMVSS
- 1B1 CODES/STANDARDS USA
- 1B1 265

FOR ELECTRICAL TORQUE SPECIFICATIONS SEE DWG NO. 128783-01-000

FOR ELECTRICAL CALLOUTS SEE DWG NO. 121339-01-000

FIRST USED	
15 J-SERIES	
DO NOT SCALE DRAWING	
TITLE: BATTERY INSTL,FD	
SHEET 4	PART NO 189259 REV
1 24-Feb-2015	

189259

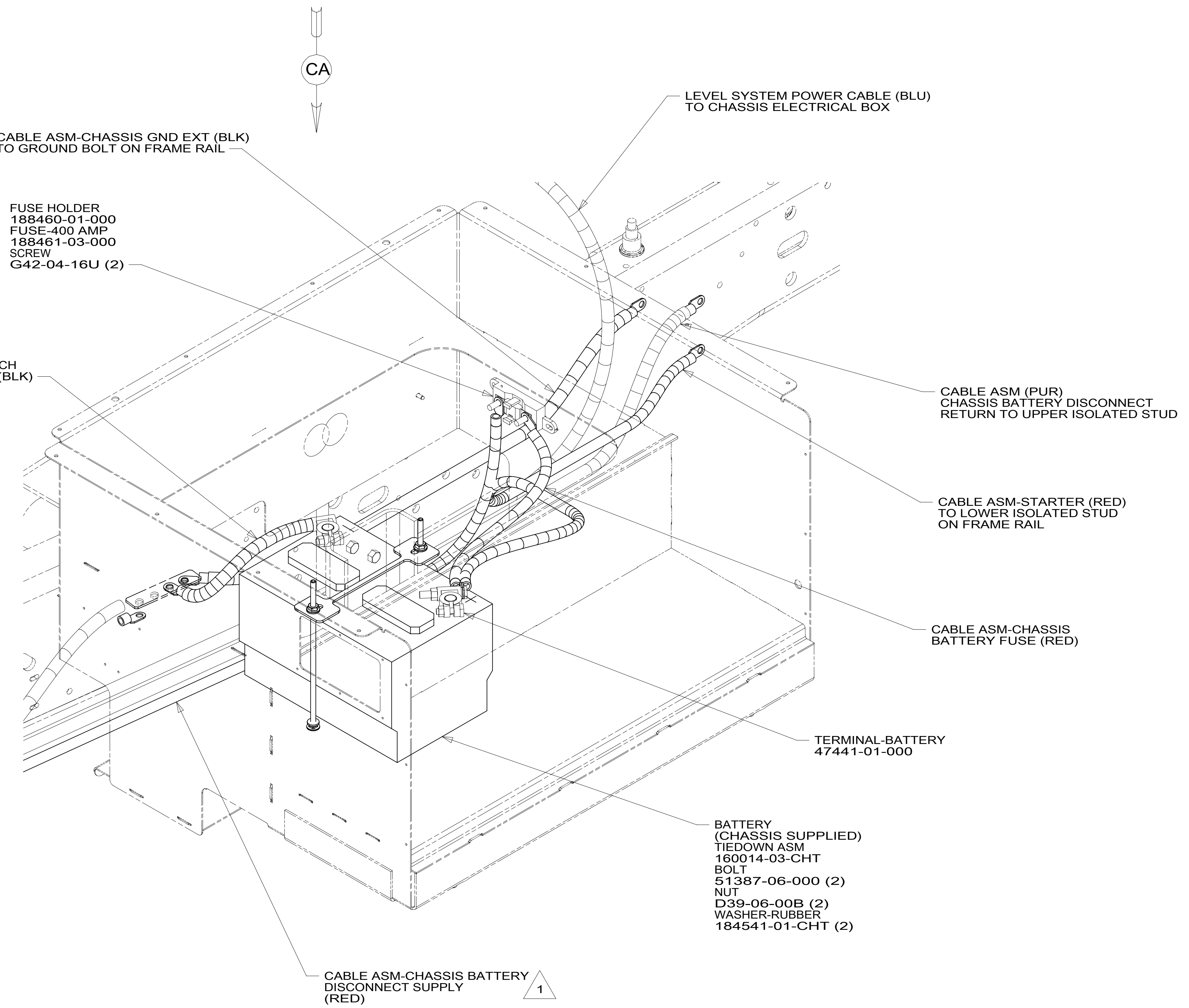

VIEW EA

- 2 SEE WIRING INSTL-CHASSIS FOR ADDITIONAL INFORMATION.
- 1 SEE CHASSIS ELECTRICAL BOX ASM FOR ADDITIONAL INFORMATION.

NOTES:

FOR ELECTRICAL TORQUE SPECIFICATIONS SEE DWG NO. 128783-01-000

FOR ELECTRICAL CALLOUTS SEE DWG NO. 121339-01-000

- 401 INVERTER-DC/AC, 1000 WATT
- 265 CODES/STANDARDS-CSA/CMVSS
- 1B1 CODES/STANDARDS USA

1B1 265

FIRST USED	
15 J-SERIES	
DO NOT SCALE DRAWING	
TITLE: BATTERY INSTL,FD	
SHEET 5	PART NO 189259 REV

*189259 *A

8

7

6

5

4

3

2

1

D

D

C

C

B

B

A

A

CABLE ASM (YEL)

FUSE HOLDER
188460-01-000
FUSE-400 AMP
188461-03-000
TIE-WIRE
008343-02-000 (2)

CABLE ASM-
COACH BATTERY
FUSE (YEL)

282 CONNECT SOLAR PANEL
GROUND HERE
CIRCUIT ZZZ
29W TAPE CIRCUIT ZZZ
BACK TO HARNESS

TO GROUND STUD
BEHIND CHASSIS
BATTERY

CABLE ASM-
TEMPERATURE BATTERY

CABLE ASM (BLK)
TO INVERTER GROUND

HOLDER-FUSE
115187-02-000
FUSE-400 AMP
115187-05-000
SCREW
G36-10-12U (2)

CABLE ASM (ORG)
TO INVERTER FUSE

BATTERY-12V
174923-01-000 (4)
BOLT
51387-06-000 (6)
NUT-HEX
D39-05-00U (6)
WASHER-RUBBER
184541-01-CHT (6)
STRAP-BATTERY
TIE DOWN
138914-01-CHT (4)

CABLE ASM (BLK)
COACH BATTERY JUMPER

CABLE ASM (YEL)
COACH BATTERY JUMPER

TRAY-BATTERY
176574-03-CHT
NUT
D39-06-00U
WASHER
E13-17-00U

VIEW FA

265 CODES/STANDARDS-CSA/CMVSS

1B1 CODES/STANDARDS USA

1B1 265

FIRST USED	
15 J-SERIES	
DO NOT SCALE DRAWING	
TITLE: BATTERY INSTL,FD	
SHEET 6	PART NO 189259 REV

FOR ELECTRICAL
TORQUE
SPECIFICATIONS
SEE DWG NO.
128783-01-000

X-X
FOR
ELECTRICAL
CALLOUTS
SEE DWG NO.
121339-01-000

8

7

6

5

4

3

2

1

189259

8

7

6

5

4

3

2

1

D

D

C

C

B

B

A

A

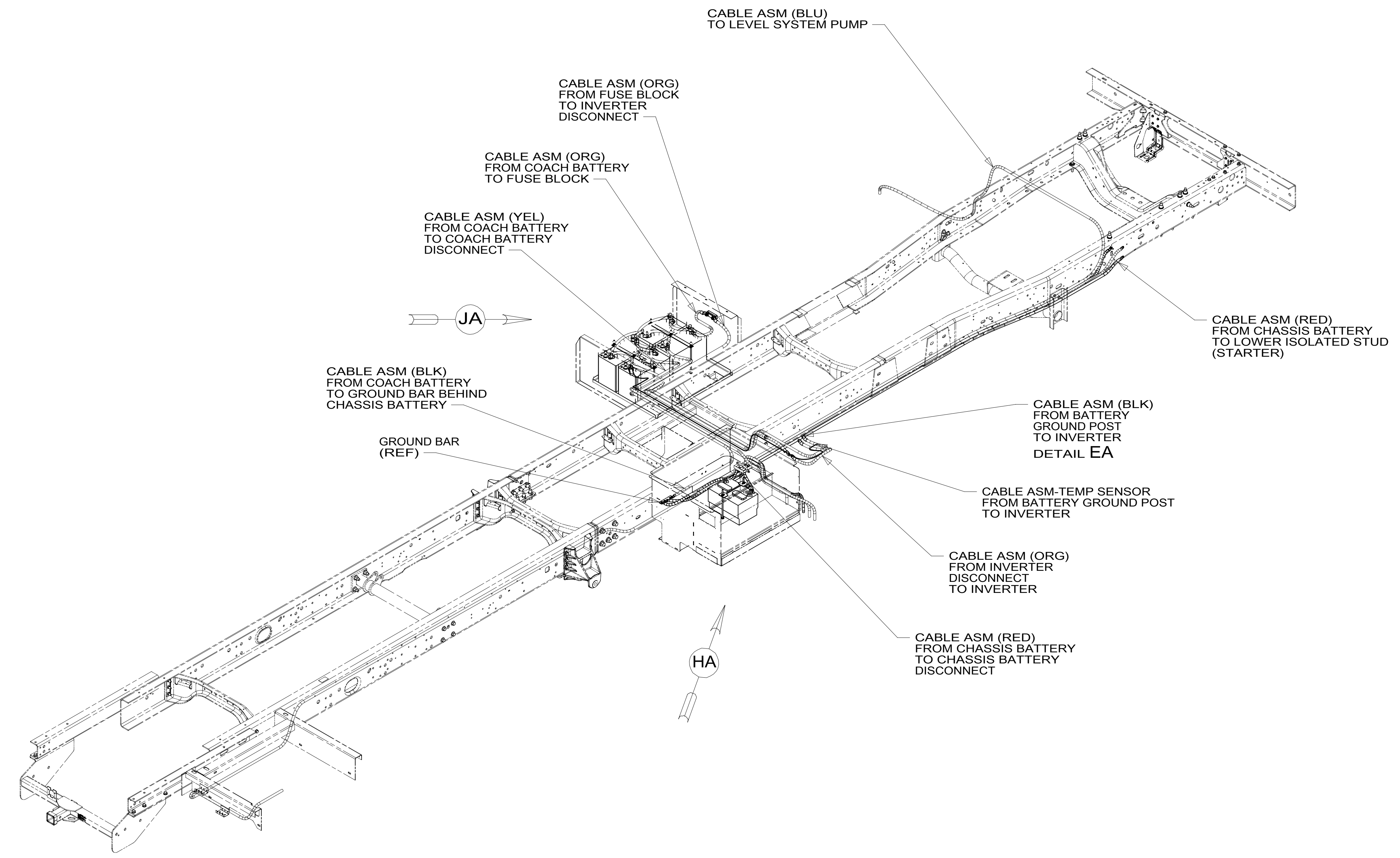

265 CODES/STANDARDS-CSA/CMVSS

1B1 CODES/STANDARDS USA

1B1 265

FIRST USED **15 J-SERIES**

DO NOT SCALE DRAWING

TITLE: **BATTERY INSTL,FD**

SHEET 7 PART NO **189259** REV

FOR ELECTRICAL TORQUE SPECIFICATIONS SEE DWG NO. 128783-01-000

FOR ELECTRICAL CALLOUTS SEE DWG NO. 121339-01-000

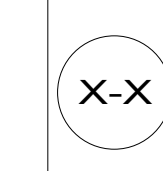

189259

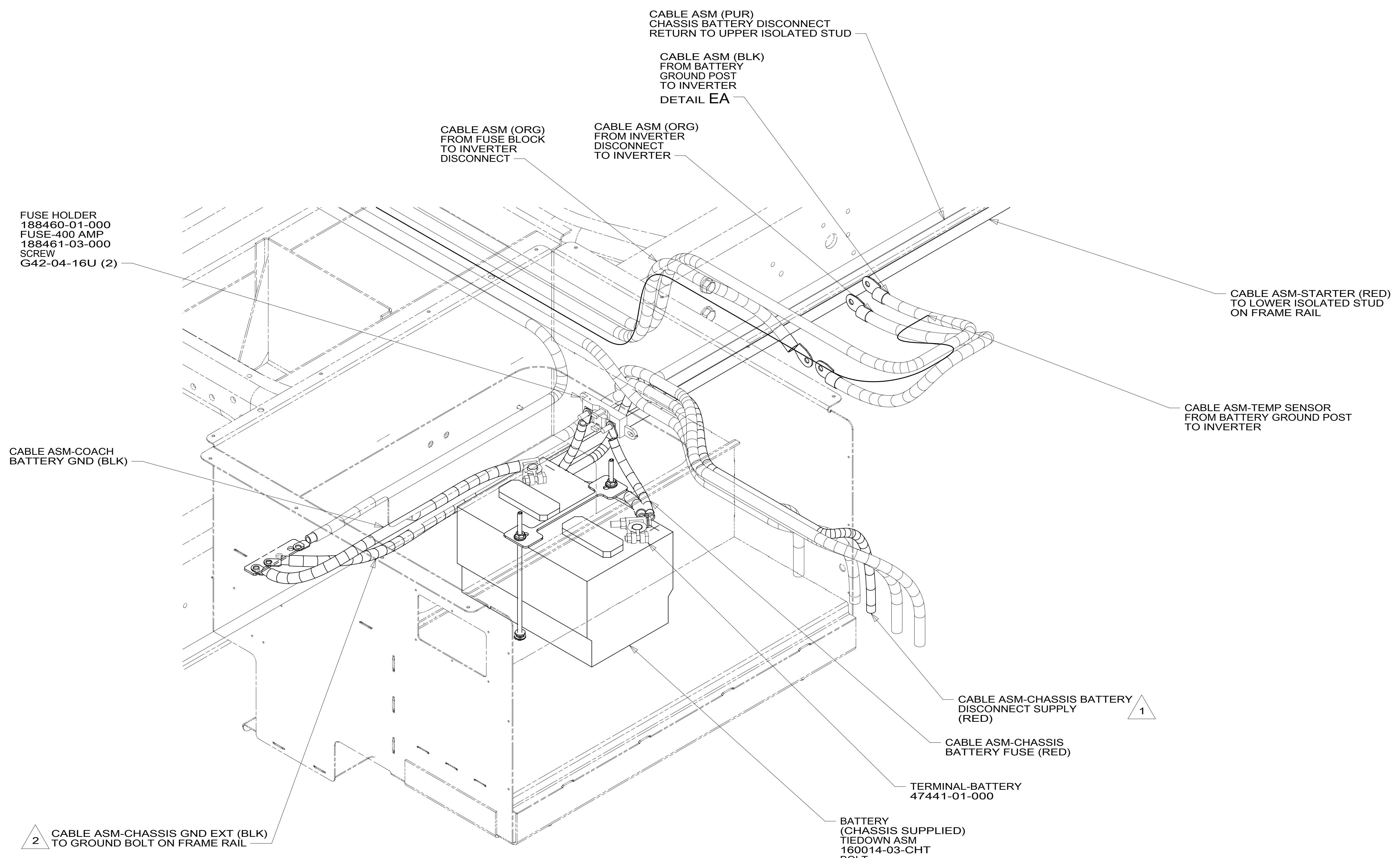

FUSE HOLDER
188460-01-000
FUSE-400 AMP
188461-03-000
SCREW
G42-04-16U (2)

CABLE ASM-COACH
BATTERY GND (BLK)

2 CABLE ASM-CHASSIS GND EXT (BLK)
TO GROUND BOLT ON FRAME RAIL

CABLE ASM (ORG)
FROM FUSE BLOCK
TO INVERTER
DISCONNECT

CABLE ASM (ORG)
FROM INVERTER
DISCONNECT
TO INVERTER

CABLE ASM (PUR)
CHASSIS BATTERY DISCONNECT
RETURN TO UPPER ISOLATED STUD

CABLE ASM (BLK)
FROM BATTERY
GROUND POST
TO INVERTER
DETAIL EA

CABLE ASM-STARTER (RED)
TO LOWER ISOLATED STUD
ON FRAME RAIL

CABLE ASM-TEMP SENSOR
FROM BATTERY GROUND POST
TO INVERTER

CABLE ASM-CHASSIS BATTERY
DISCONNECT SUPPLY (RED) 1

CABLE ASM-CHASSIS
BATTERY FUSE (RED)

TERMINAL-BATTERY
47441-01-000

BATTERY
(CHASSIS SUPPLIED)
TIEDOWN ASM
160014-03-CHT
BOLT
51387-06-000 (2)
NUT
D39-06-00B (2)
WASHER-RUBBER
184541-01-CHT (2)

VIEW HA

- NOTES:
- 2 SEE WIRING INSTL-CHASSIS FOR ADDITIONAL INFORMATION.
 - 1 SEE CHASSIS ELECTRICAL BOX ASM FOR ADDITIONAL INFORMATION.

FOR ELECTRICAL
TORQUE
SPECIFICATIONS
SEE DWG NO.
128783-01-000

FOR
ELECTRICAL
CALLOUTS
SEE DWG NO.
121339-01-000

- 401 INVERTER-DC/AC, 1000 WATT
- 265 CODES/STANDARDS-CSA/CMVSS
- 1B1 CODES/STANDARDS USA

1B1 265

FIRST USED	
15 J-SERIES	
DO NOT SCALE DRAWING	
TITLE: BATTERY INSTL,FD	
SHEET 8	PART NO 189259 REV
1 24-Feb-2015	

189259

8 7 6 5 4 3 2 1

D

D

C

C

B

B

A

A

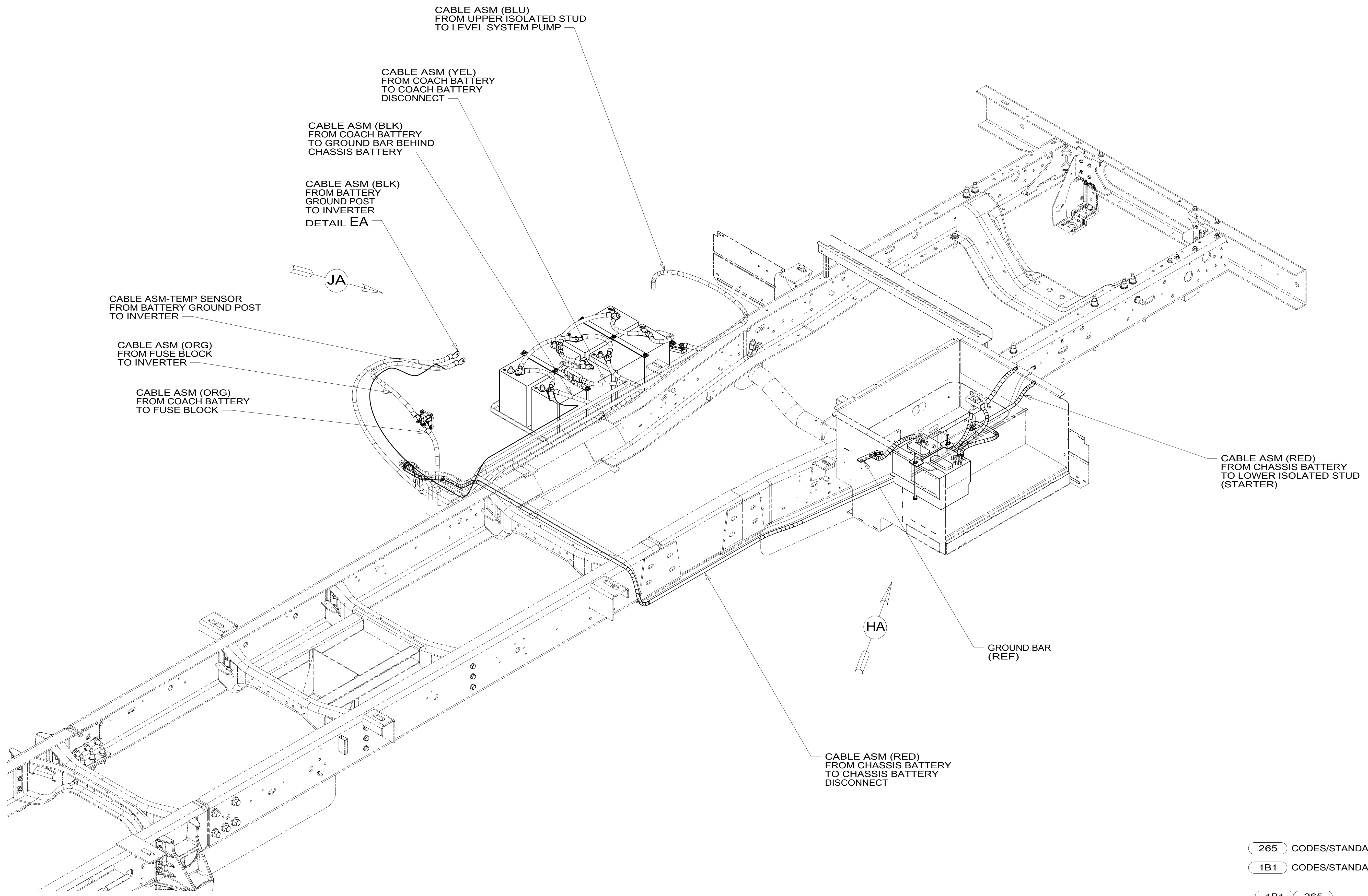

265 CODES/STANDARDS-CSA/CMVSS

1B1 CODES/STANDARDS USA

1B1 265

FIRST USED 15 J-SERIES

DO NOT SCALE DRAWING

TITLE: BATTERY INSTL,FD

SHEET 10 PART NO 189259 REV

1 24-Feb-2015

FOR ELECTRICAL TORQUE SPECIFICATIONS SEE DWG NO. 128783-01-000

FOR ELECTRICAL CALLOUTS SEE DWG NO. 121339-01-000

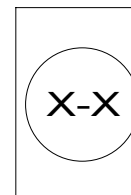

8 7 6 5 4 3 2 1

189259

GENERATOR

INVERTER

LEVELING PUMP

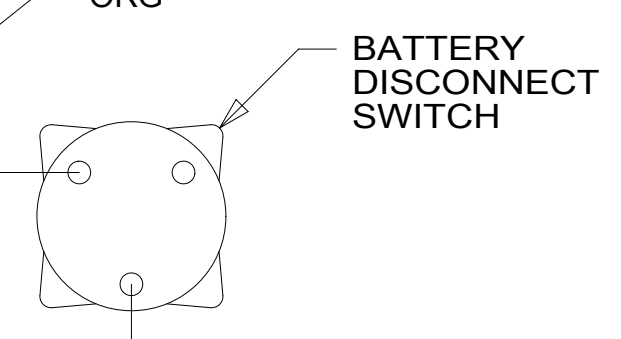

HOUSE BATTERY BANK

CHASSIS BATTERY BANK

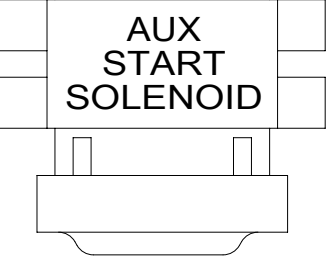

COACH DISCONNECT

CHASSIS DISCONNECT

CHASSIS SUPPLIED STARTER CABLE

CHASSIS SUPPLIED ELECTRICAL PANEL/ALTERNATOR CABLE

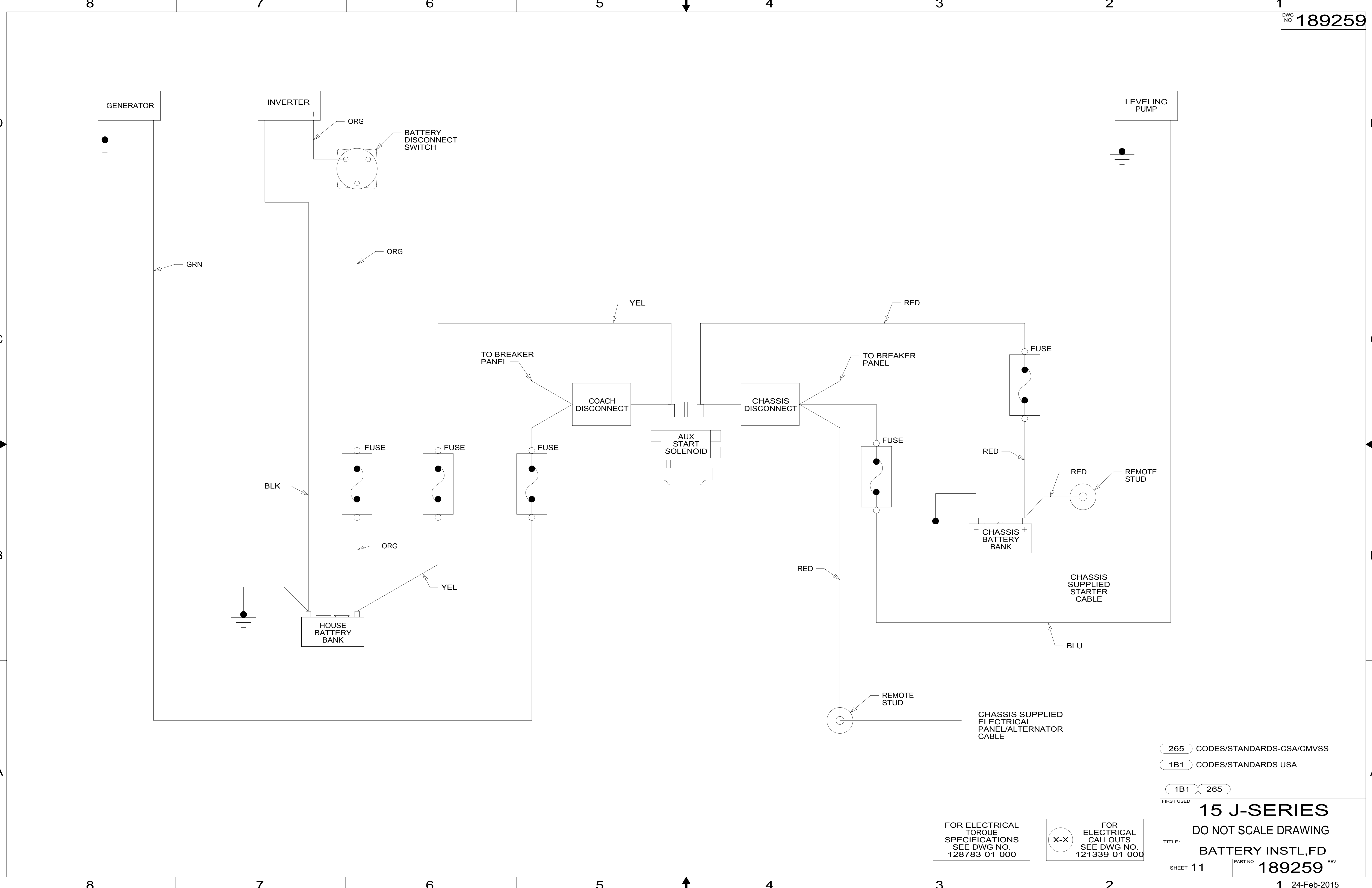

265 CODES/STANDARDS-CSA/CMVSS

1B1 CODES/STANDARDS USA

1B1 265

FIRST USED 15 J-SERIES

DO NOT SCALE DRAWING

TITLE: BATTERY INSTL,FD

SHEET 11 PART NO 189259 REV

1 24-Feb-2015

FOR ELECTRICAL TORQUE SPECIFICATIONS SEE DWG NO. 128783-01-000

FOR ELECTRICAL CALLOUTS SEE DWG NO. 121339-01-000

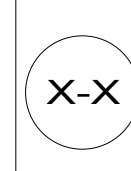

189259