



**DANGER**

**Danger of electrical shock, burns or death.** Always remove all power sources before attempting any repair, service or diagnostic work. Power can be present from shore power, generator, inverter or battery. All power sources must be disabled and secured before performing any service.



**CAUTION**

If you lack the skills, tools or equipment to perform diagnostic or repair work leave such work to an authorized Winnebago Industries dealer or other qualified shop.

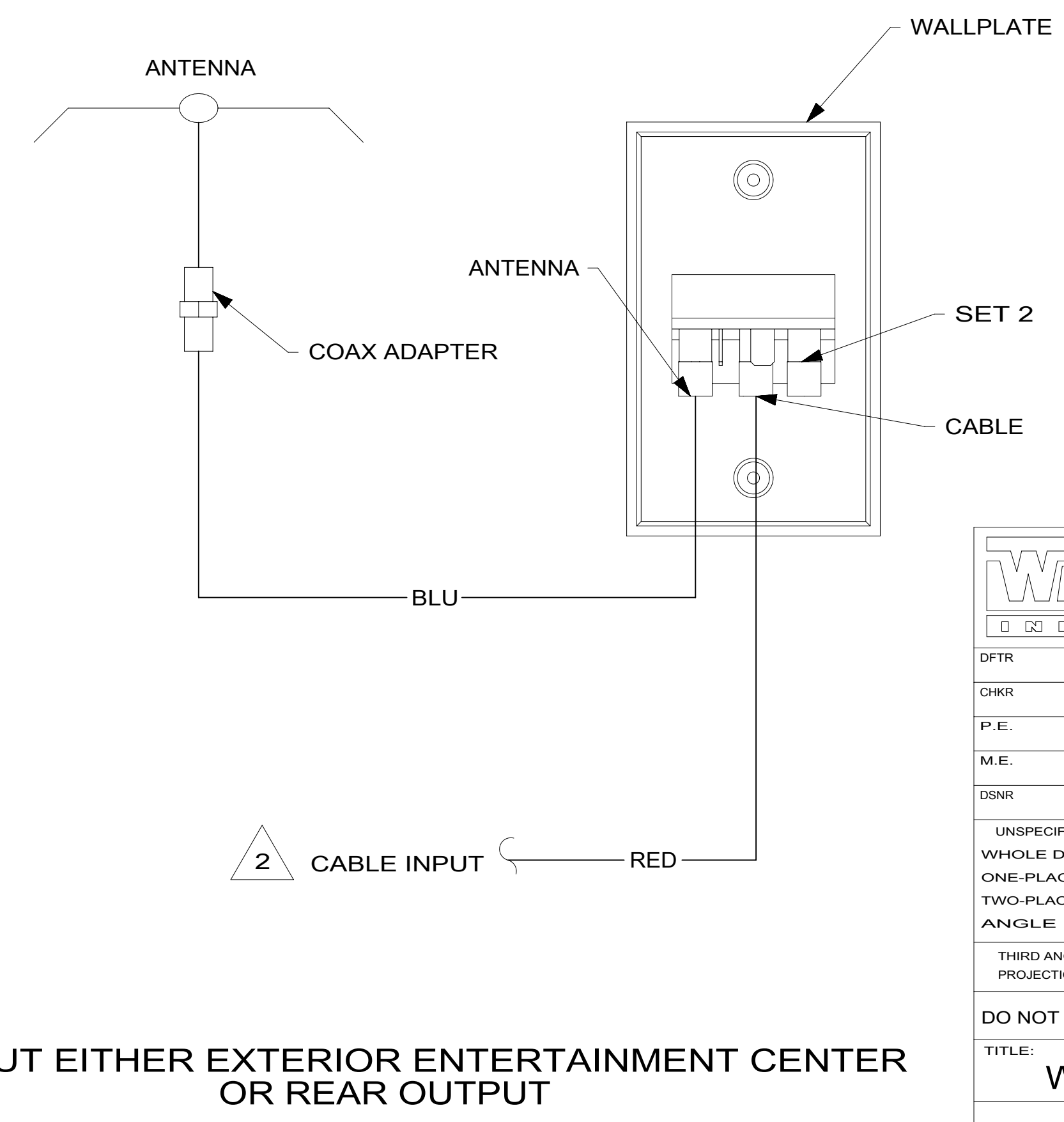
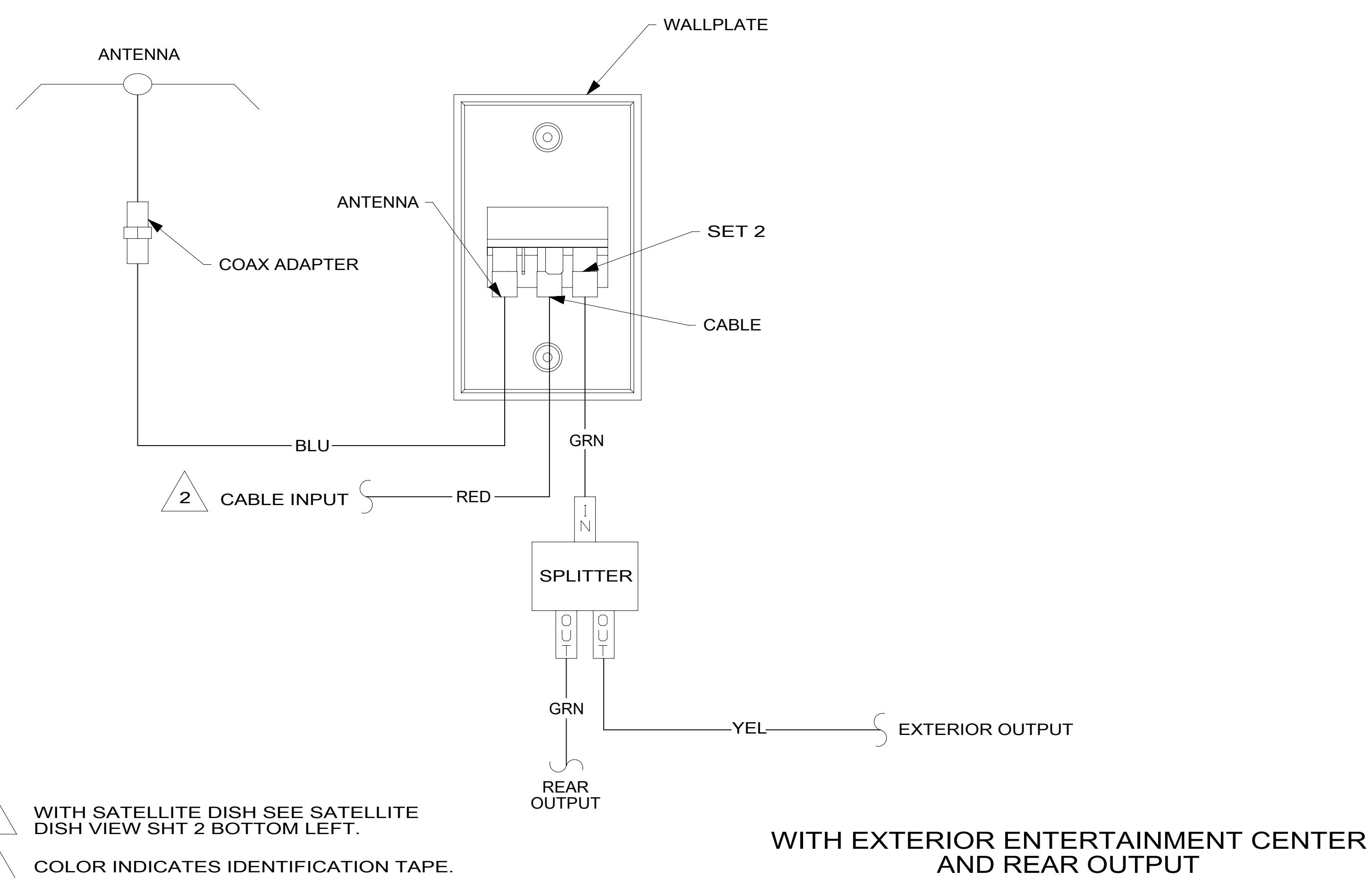
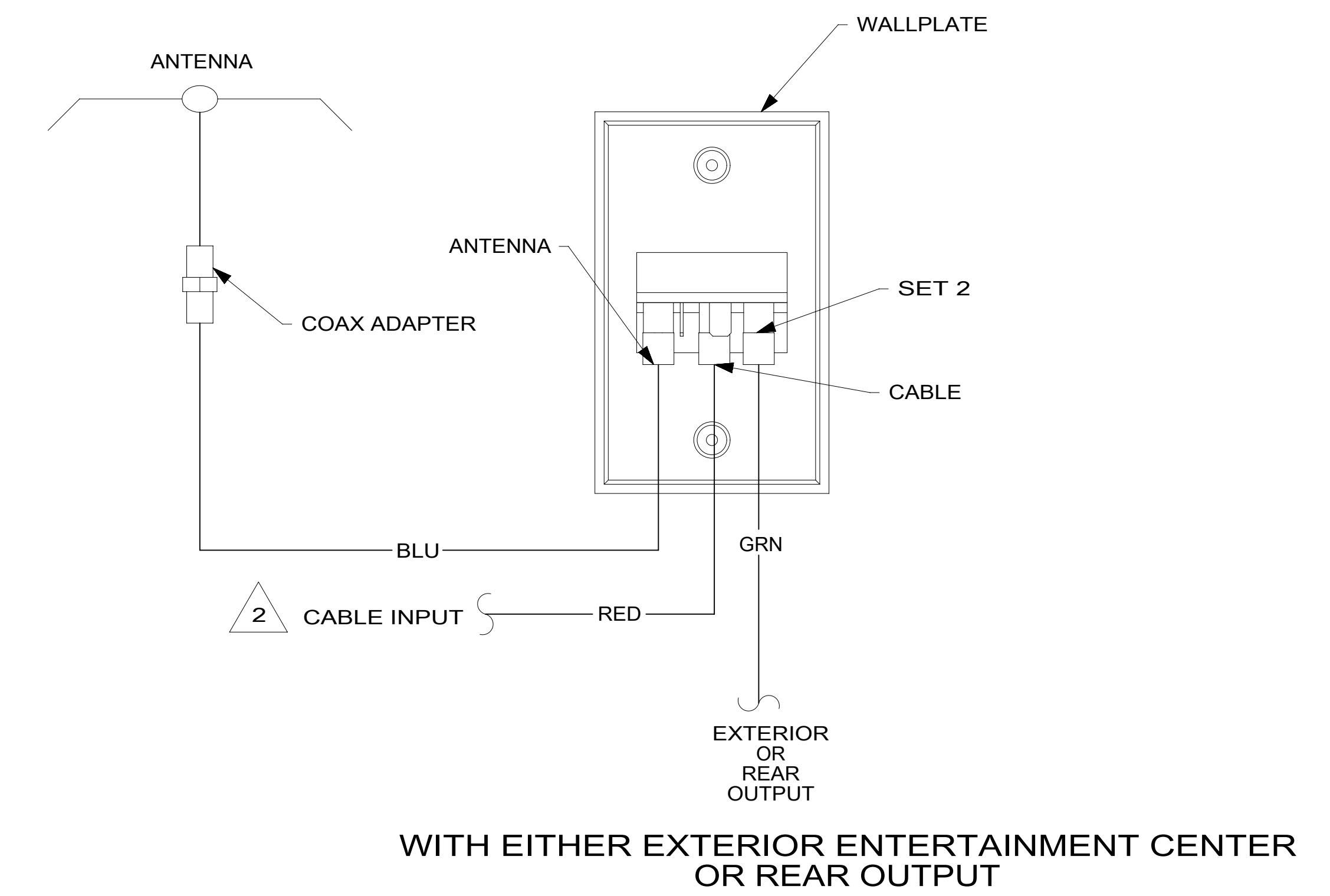
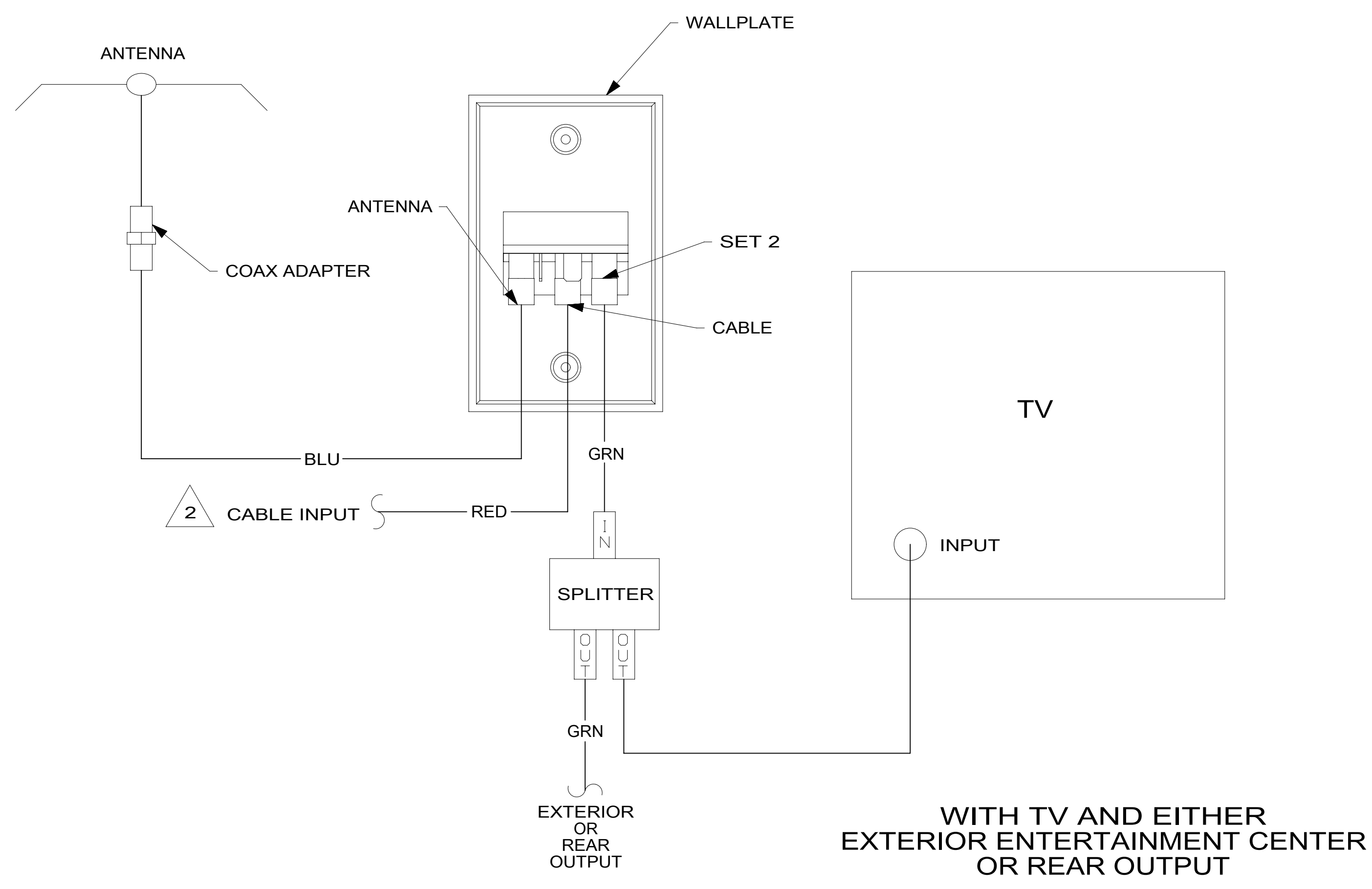

2 WITH SATELLITE DISH SEE SATELLITE DISH VIEW SHT 2 BOTTOM LEFT.

1 COLOR INDICATES IDENTIFICATION TAPE.

NOTES:

<b>WINNEBAGO</b>		COPYRIGHT 2014 WINNEBAGO INDUSTRIES, INC.	
DFT-ORIG	ORIG. DATE	ALL DIMENSIONS ARE IN MILLIMETERS	
CHKR		FIRST USED	
P.E.		93 MOTORHAMES	
M.E.		MATERIAL:	
DSNR		UNSPECIFIED TOLERANCES ARE:	
		WHOLE DIM (X)	:
		ONE-PLACE (X.X)	:
		TWO-PLACE (X.XX)	:
		ANGLE	:
		THIRD ANGLE PROJECTION	
DO NOT SCALE DRAWING		REFER TO ES0018 FOR FASTENER TIGHTENING GUIDELINES	
TITLE: WIRING DIAGRAM-TV COAX			
SHEET 1 OF 2		PART NO	110138
REF:		1 08-Jul-2015	

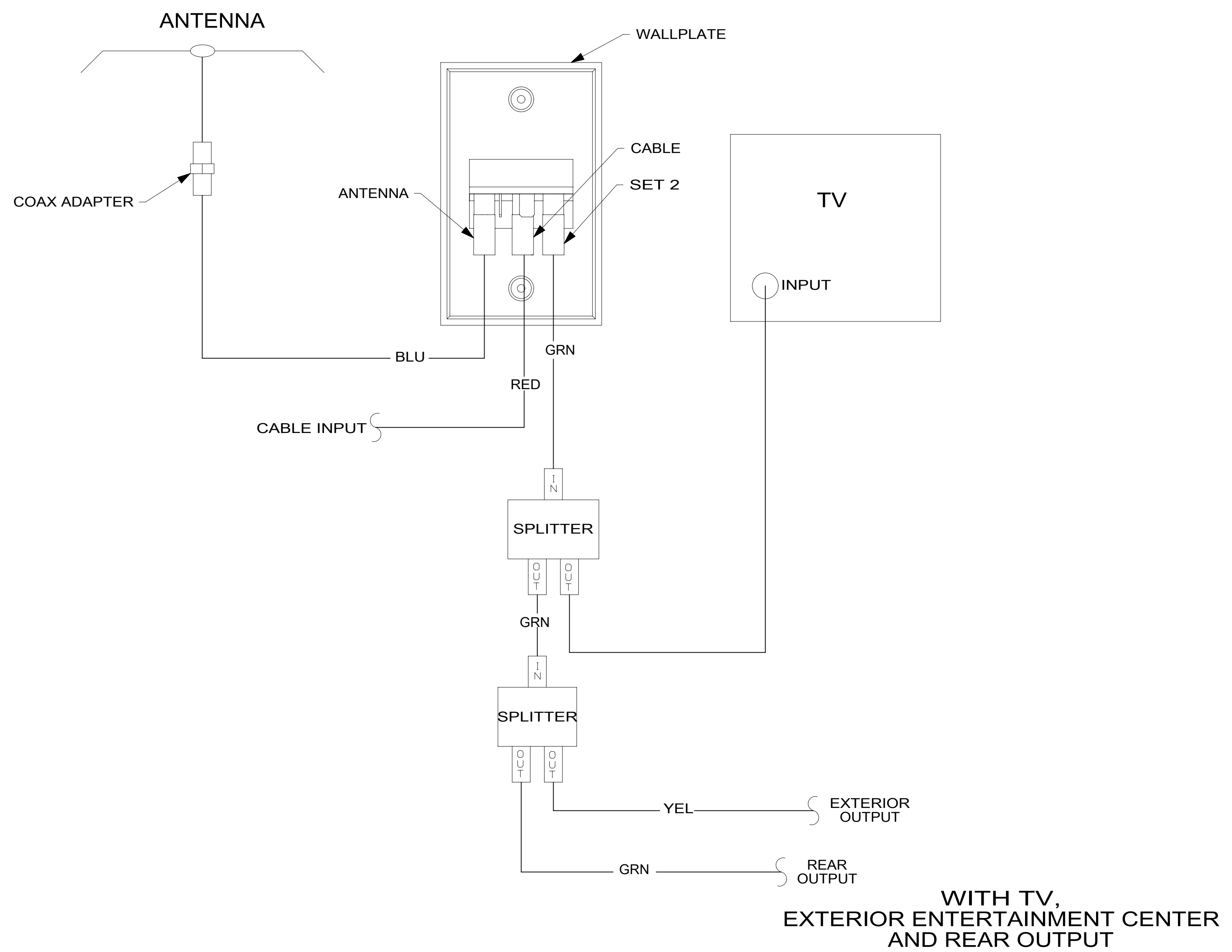

WITH TV, EXTERIOR ENTERTAINMENT CENTER AND REAR OUTPUT

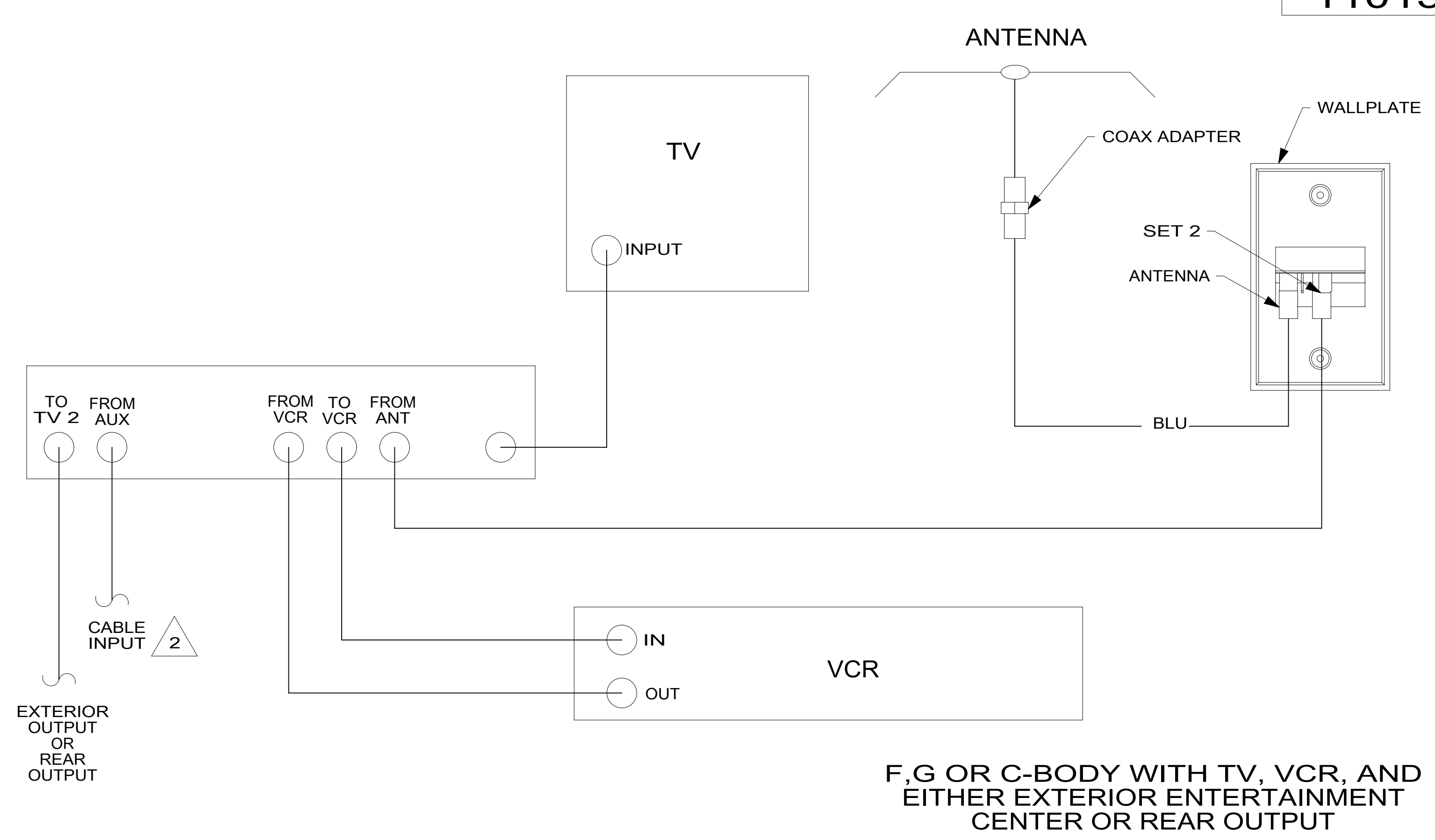

F,G OR C-BODY WITH TV, VCR, AND EITHER EXTERIOR ENTERTAINMENT CENTER OR REAR OUTPUT

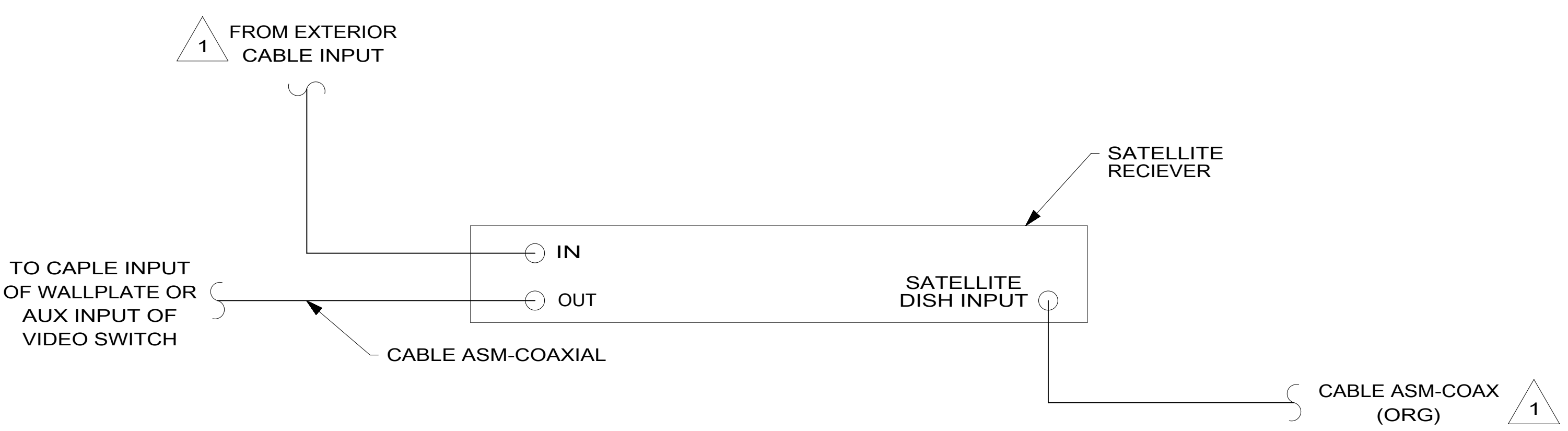

- NOTES:
- 2 WITH SATELLITE DISH SEE SATELLITE DISH VIEW BOTTOM LEFT.
  - 1 CONNECT TV COAX TO JACK ON FRONT OF WALLPLATE.

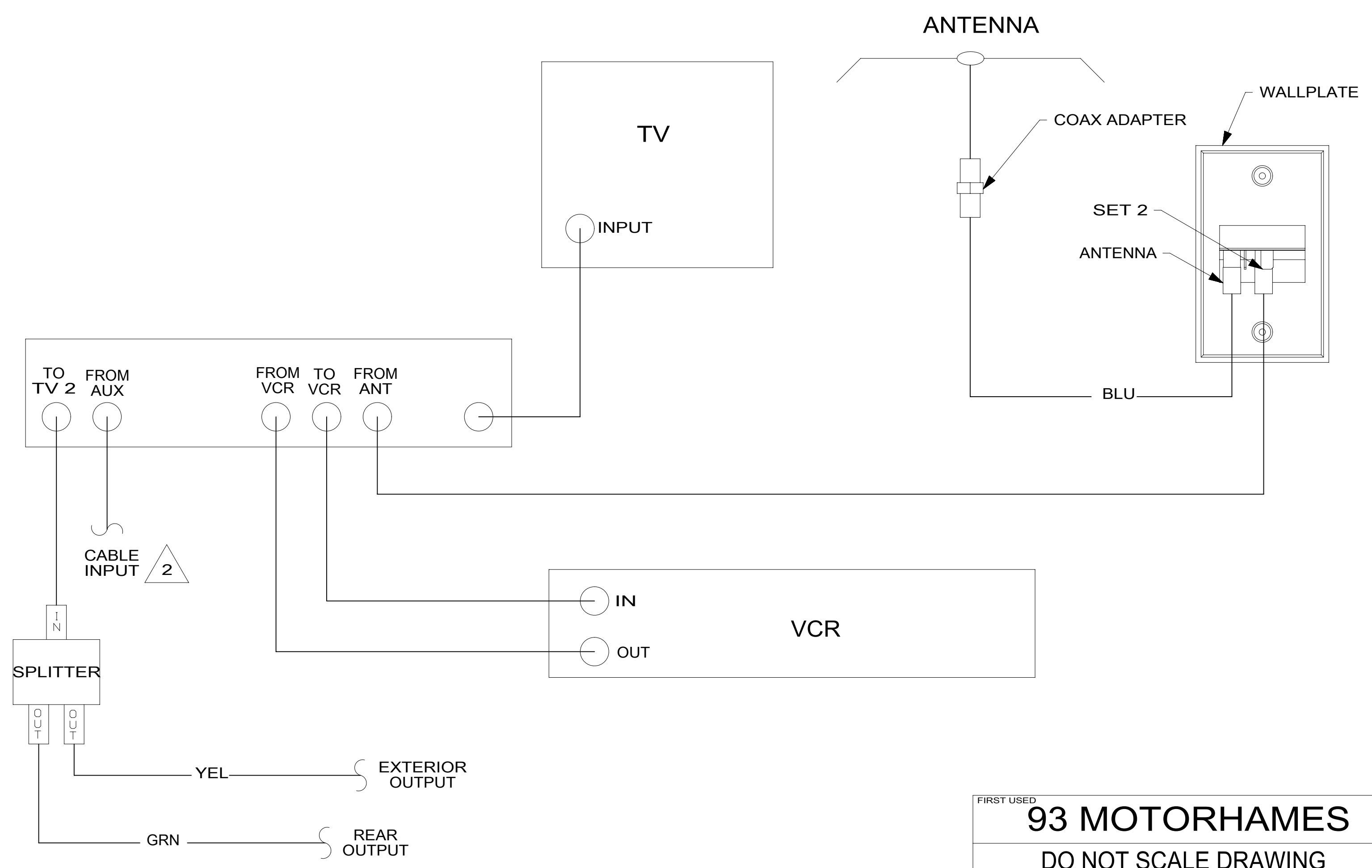

N,M OR P-SERIES WITH TV AND VCR OR F,G OR C-BODY WITH TV, VCR, EXTERIOR ENTERTAINMENT CENTER AND REAR OUTPUT

FIRST USED	93 MOTORHAMES
DO NOT SCALE DRAWING	
TITLE: WIRING DIAGRAM-TV COAX	
SHEET 2	PART NO 110138
08-Jul-2015	