



DANGER

Danger of electrical shock, burns or death. Always remove all power sources before attempting any repair, service or diagnostic work. Power can be present from shore power, generator, inverter or battery. All power sources must be disabled and secured before performing any service.



CAUTION

If you lack the skills, tools or equipment to perform diagnostic or repair work leave such work to an authorized Winnebago Industries dealer or other qualified shop.

DRAWING NO.	FEATURE
186551-01	-----
186551-12	1B1 78J
186551-16	265 78J

RELEASE	REV/DATE	DWG NO	186551
REV ZONE	REVISION RECORD	DATE	DFT-ORIG

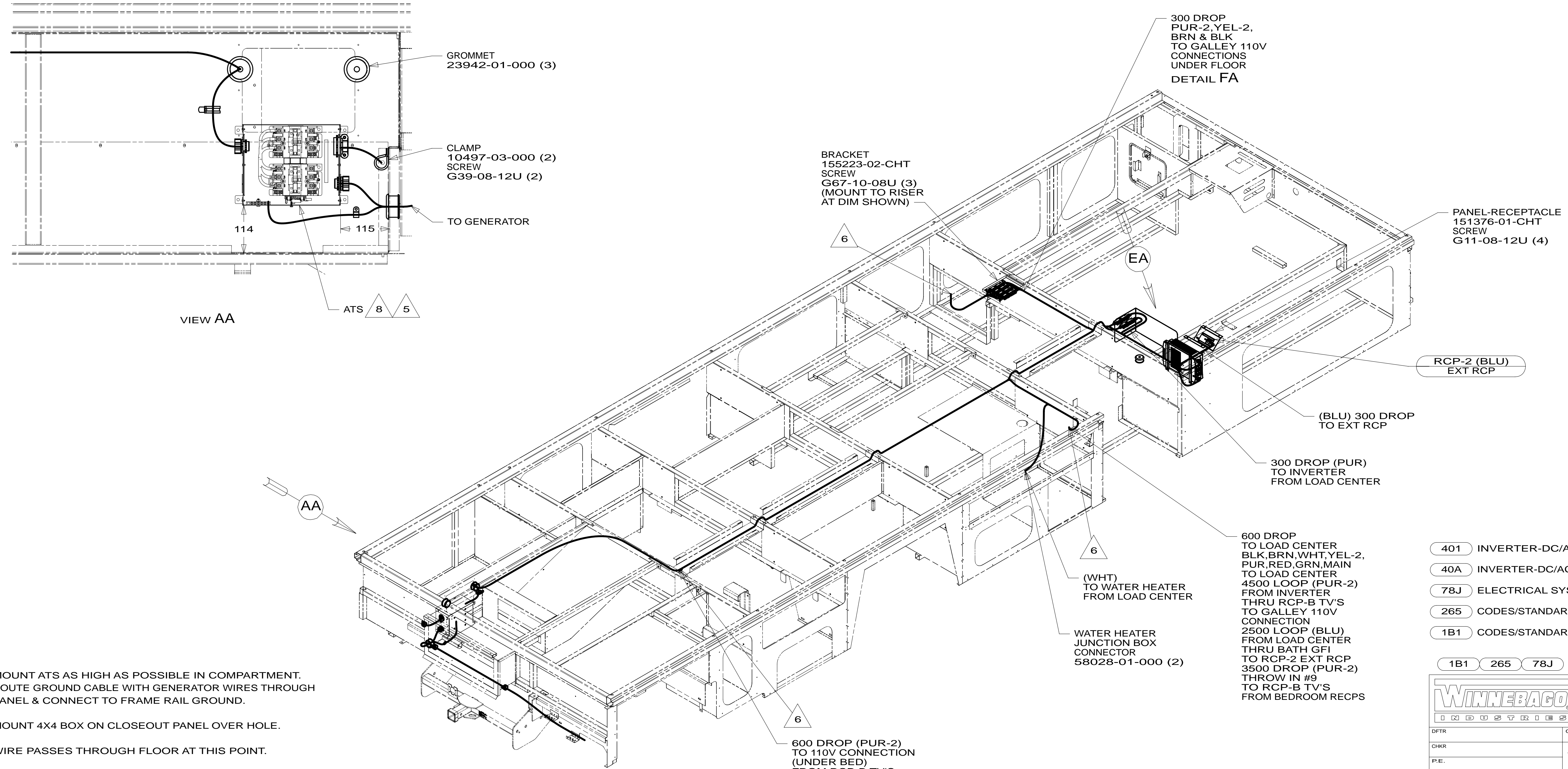

VIEW AA

- 8 MOUNT ATS AS HIGH AS POSSIBLE IN COMPARTMENT. ROUTE GROUND CABLE WITH GENERATOR WIRES THROUGH PANEL & CONNECT TO FRAME RAIL GROUND.
- 7 MOUNT 4X4 BOX ON CLOSEOUT PANEL OVER HOLE.
- 6 WIRE PASSES THROUGH FLOOR AT THIS POINT.
- 5 SEE LOAD CENTER/ATS ASM FOR ADDITIONAL INFORMATION.

- 4. SEE WIRING DIAGRAM-BODY,110V FOR ADDITIONAL INFORMATION.
- 3. ALL GROUND WIRE TO BE COVERED WITH TUBING 8041-02-000.
- 2. ALL 110V WIRE TO BE CLAMPED WITH CLAMP 10497-05-000 WITHIN 200MM OF OUTLET BOXES, USE SCREW G67-10-12B.
- 1. ALL WIRES TO BE SECURED WITH CLAMP 10495-01-000 OR CLIP 80734-01-000 EVERY 600MM. USE SCREW G67-10-12B UNLESS OTHERWISE SPECIFIED.

NOTES:

- 401 INVERTER-DC/AC, 1000 WATT
- 40A INVERTER-DC/AC WITHOUT
- 78J ELECTRICAL SYSTEM-50 AMP
- 265 CODES/STANDARDS-CSA/CMVSS
- 1B1 CODES/STANDARDS USA

- 1B1 265 78J

WINNEBAGO COPYRIGHT 2014 WINNEBAGO INDUSTRIES, INC.

DFT-ORIG	ORIG. DATE
CHKR	ALL DIMENSIONS ARE IN MILLIMETERS
P.E.	
M.E.	FIRST USED
DSNR	14 J32H

UNSPECIFIED TOLERANCES ARE:

WHOLE DIM (X)	: 3
ONE-PLACE (X.X)	: 1.5
TWO-PLACE (X.XX)	: 0.50
ANGLE	: 1°

THIRD ANGLE PROJECTION

DO NOT SCALE DRAWING REFER TO ES0018 FOR FASTENER TIGHTENING GUIDELINES

TITLE: **WIRING INSTL-BODY,110V**

SHEET 1 OF 7 PART NO **186551** REV

REF: 1 27-Jun-2014

FOR ELECTRICAL TORQUE SPECIFICATIONS SEE DWG NO. 128783-01-000

FOR ELECTRICAL CALLOUTS SEE DWG NO. 121339-01-000

* 186551 *

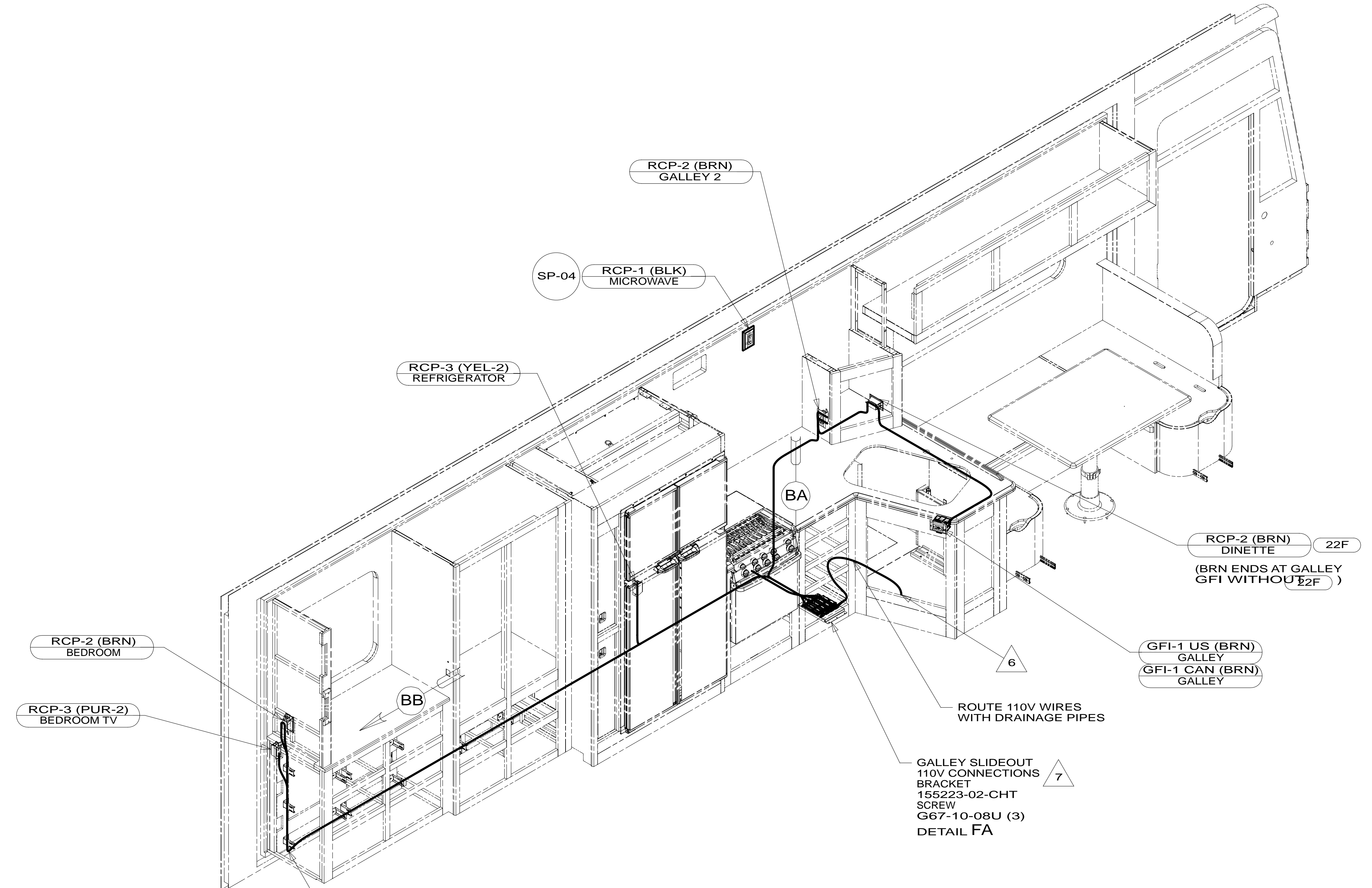

- 8 CLEAN AND APPLY ADHESIVE PROMOTER 900680-04-000 TO BOTH SURFACES AND BOND WITH TAPE 76322-23-000 (900MM) AROUND ENTIRE PERIMETER OF BRACKET
 - 7 LOCATING DIMENSION SEE DETAIL BA
 - 6 WIRE ROUTED THROUGH FLOOR AT THIS POINT.
 - 5 SEE LOAD CENTER/ATS ASM FOR ADDITIONAL INFORMATION.
 - 4. SEE WIRING DIAGRAM-BODY,110V FOR ADDITIONAL INFORMATION.
 - 3. ALL GROUND WIRE TO BE COVERED WITH TUBING 8041-02-000.
 - 2. ALL 110V WIRE TO BE CLAMPED WITH CLAMP 10497-05-000 WITHIN 200MM OF OUTLET BOXES, USE SCREW G67-10-12B.
 - 1. ALL WIRES TO BE SECURED WITH CLAMP 10495-01-000 OR CLIP 80734-01-000 EVERY 600MM. USE SCREW G67-10-12B UNLESS OTHERWISE SPECIFIED.
- NOTES:

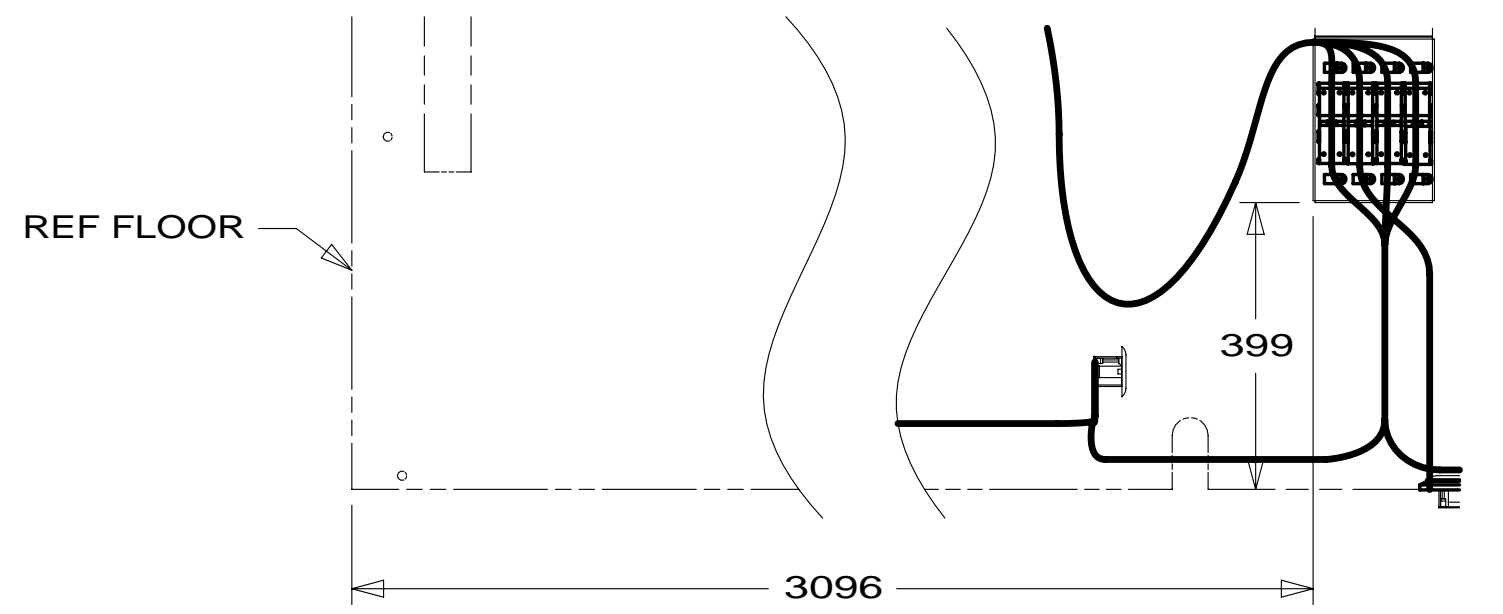

DETAIL BA

FOR ELECTRICAL TORQUE SPECIFICATIONS SEE DWG NO. 128783-01-000

FOR ELECTRICAL CALLOUTS SEE DWG NO. 121339-01-000

- 22F DINETTE, U-SHAPED ULTRALEATH
- 78J ELECTRICAL SYSTEM-50 AMP
- 265 CODES/STANDARDS-CSA/CMVSS
- 1B1 CODES/STANDARDS USA

1B1	265	78J
FIRST USED		
14 J32H		
DO NOT SCALE DRAWING		
TITLE: WIRING INSTL-BODY,110V		
SHEET 2	PART NO 186551	REV

* 186551 * A

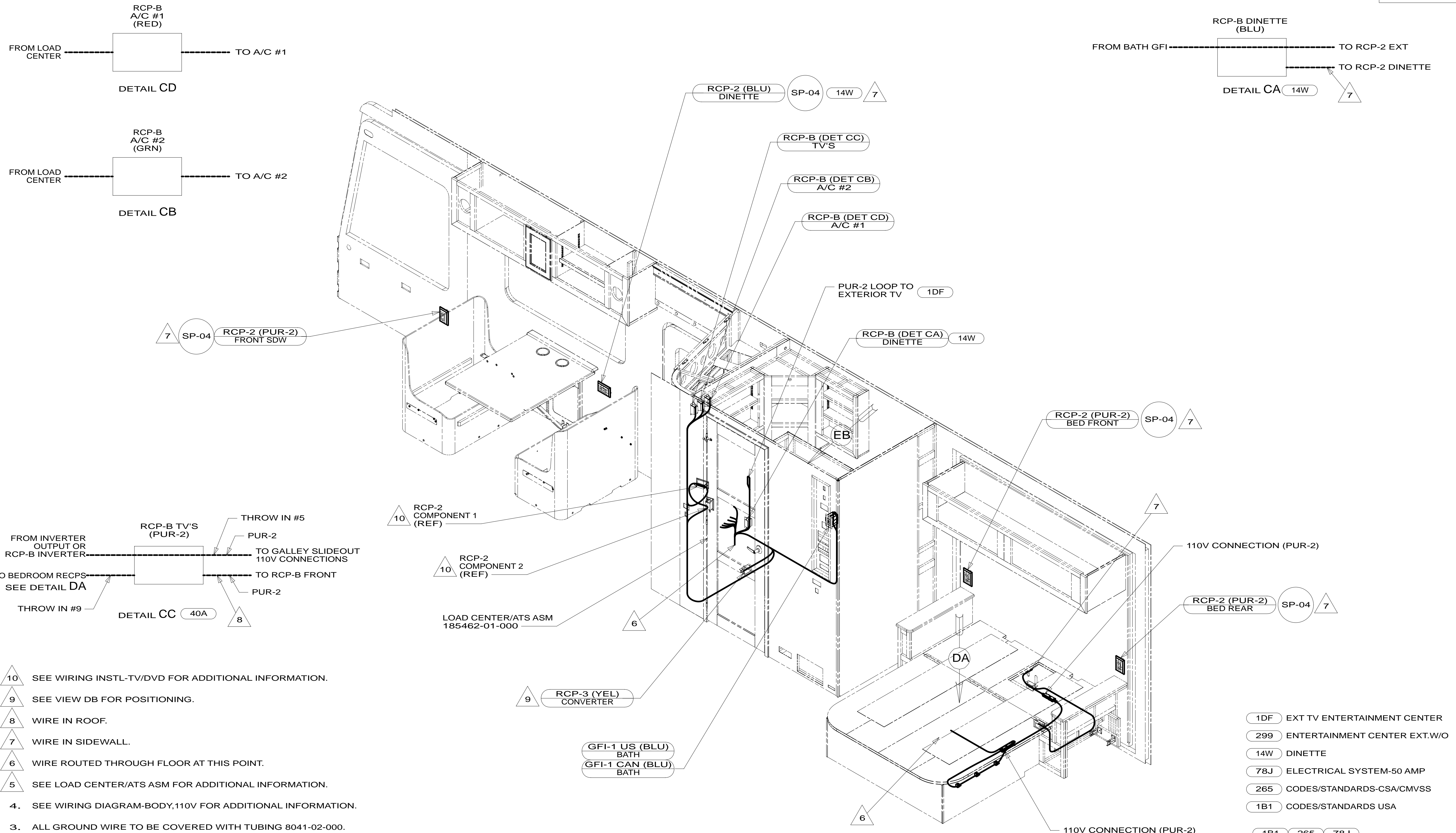

- NOTES:
- 10 SEE WIRING INSTL-TV/DVD FOR ADDITIONAL INFORMATION.
 - 9 SEE VIEW DB FOR POSITIONING.
 - 8 WIRE IN ROOF.
 - 7 WIRE IN SIDEWALL.
 - 6 WIRE ROUTED THROUGH FLOOR AT THIS POINT.
 - 5 SEE LOAD CENTER/ATS ASM FOR ADDITIONAL INFORMATION.
 - 4. SEE WIRING DIAGRAM-BODY,110V FOR ADDITIONAL INFORMATION.
 - 3. ALL GROUND WIRE TO BE COVERED WITH TUBING 8041-02-000.
 - 2. ALL 110V WIRE TO BE CLAMPED WITH CLAMP 10497-05-000 WITHIN 200MM OF OUTLET BOXES, USE SCREW G67-10-12B.
 - 1. ALL WIRES TO BE SECURED WITH CLAMP 10495-01-000 OR CLIP 80734-01-000 EVERY 600MM. USE SCREW G67-10-12B UNLESS OTHERWISE SPECIFIED.

FOR ELECTRICAL TORQUE SPECIFICATIONS SEE DWG NO. 128783-01-000

X-X FOR ELECTRICAL CALLOUTS SEE DWG NO. 121339-01-000

- 1DF EXT TV ENTERTAINMENT CENTER
- 299 ENTERTAINMENT CENTER EXT.W/O
- 14W DINETTE
- 78J ELECTRICAL SYSTEM-50 AMP
- 265 CODES/STANDARDS-CSA/CMVSS
- 1B1 CODES/STANDARDS USA

FIRST USED	
14 J32H	
DO NOT SCALE DRAWING	
TITLE: WIRING INSTL-BODY,110V	
SHEET 3	PART NO 186551 REV

* 186551 *

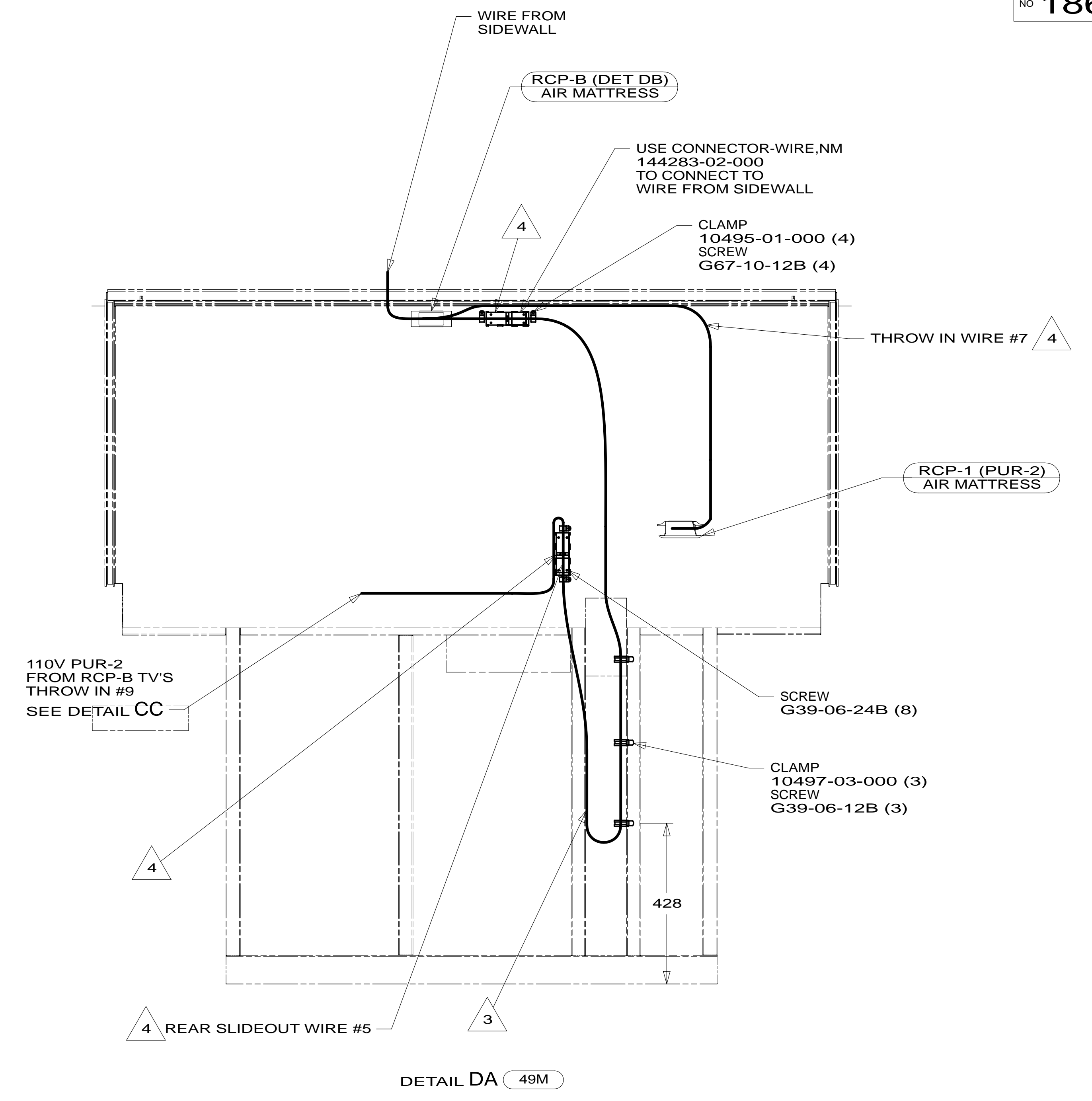
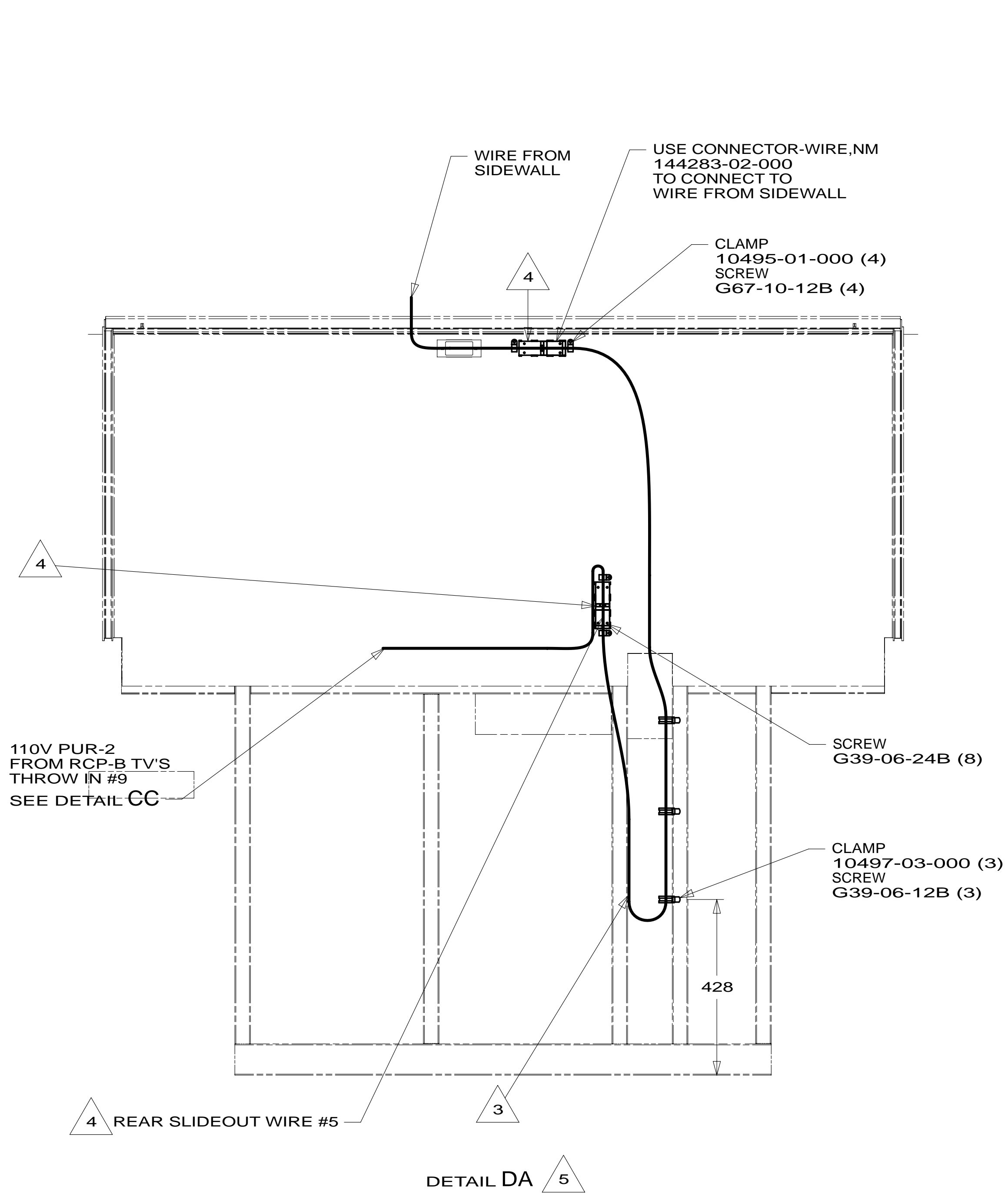

- NOTES:
- 5 WITHOUT 49M
 - 4 SEE LOAD CENTER/ATS ASM FOR ADDITIONAL INFORMATION.
 - 3 MAKE LOOP AS SMALL AS POSSIBLE WHEN SLIDEOUT IS COMPLETELY RETRACTED.
 - 2. RUN 12V WIRE ALONG WITH REAR SLIDEOUT WIRE.
 - 1. WIRE MUST BE ROUTED THROUGH CLAMPS AS SHOWN.

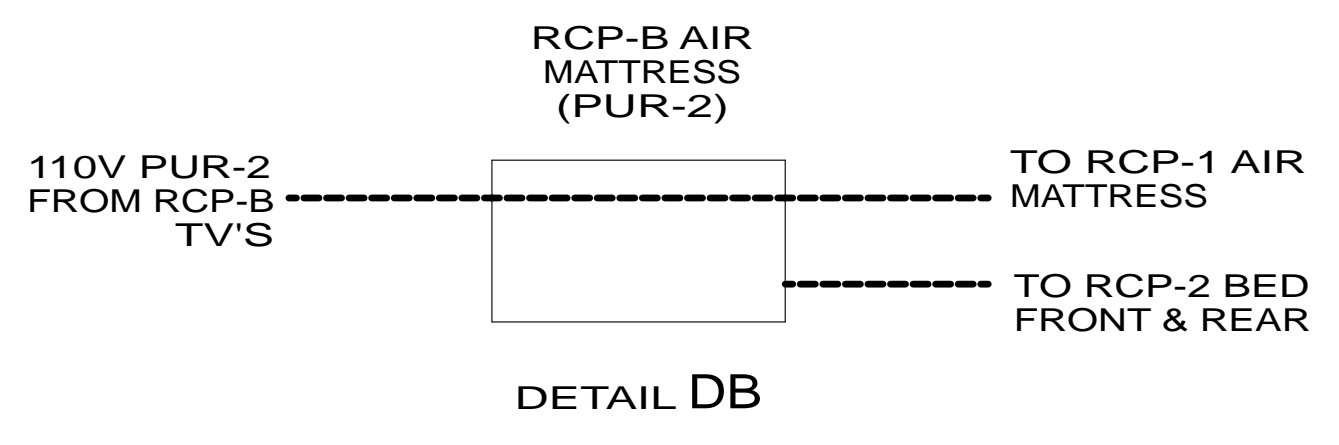

FOR ELECTRICAL TORQUE SPECIFICATIONS SEE DWG NO. 128783-01-000

FOR ELECTRICAL CALLOUTS SEE DWG NO. 121339-01-000

- 49M AIR SLEEP SYSTEM-QUEEN SIZE
- 78J ELECTRICAL SYSTEM-50 AMP
- 265 CODES/STANDARDS-CSA/CMVSS
- 1B1 CODES/STANDARDS USA

FIRST USED	14 J32H	
DO NOT SCALE DRAWING		
WIRING INSTL-BODY, 110V		
SHEET 4	PART NO 186551	REV
		1 27-Jun-2014

* 186551 * A

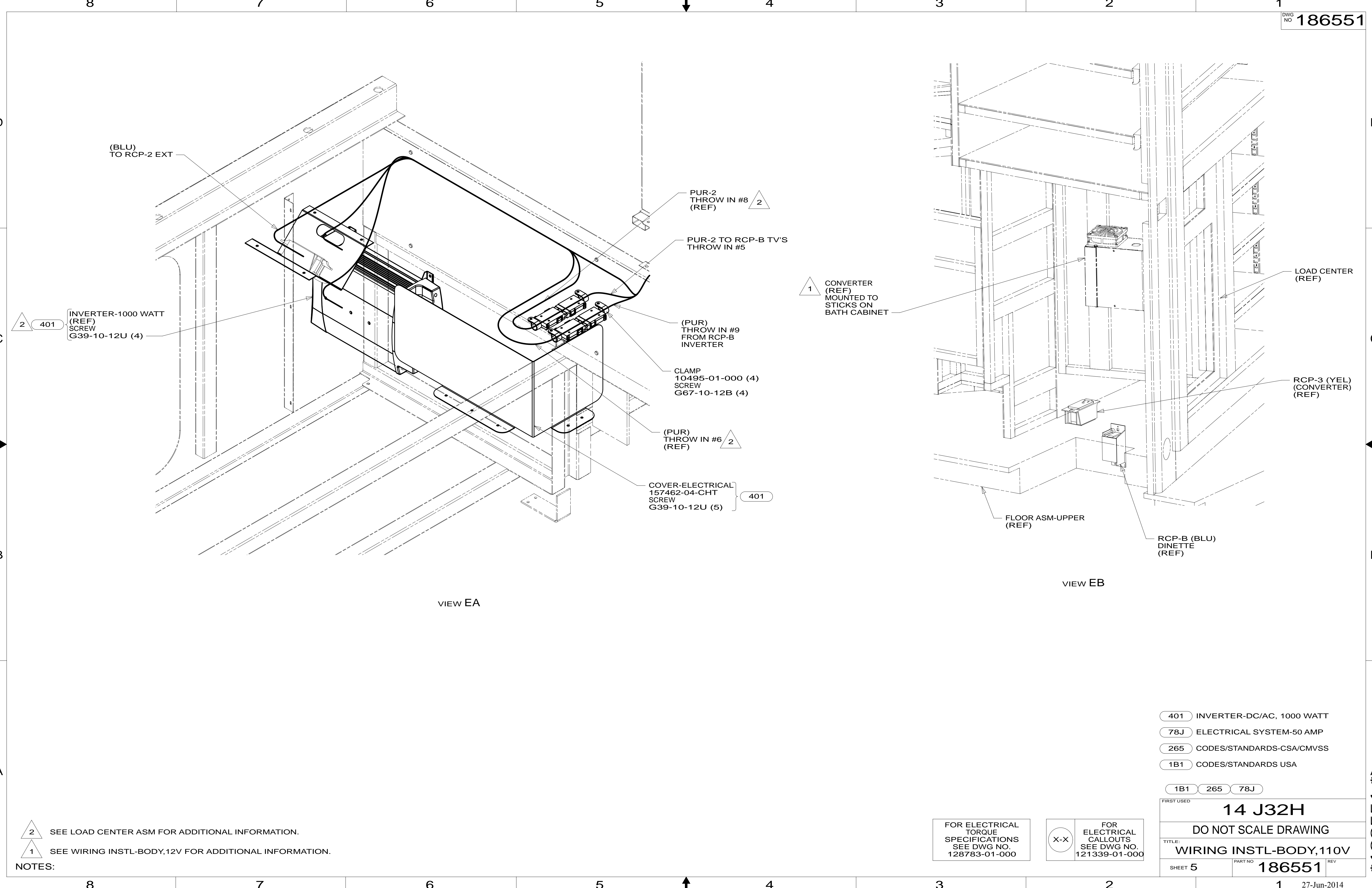

2 SEE LOAD CENTER ASM FOR ADDITIONAL INFORMATION.
 1 SEE WIRING INSTL-BODY,12V FOR ADDITIONAL INFORMATION.

NOTES:

- 401 INVERTER-DC/AC, 1000 WATT
- 78J ELECTRICAL SYSTEM-50 AMP
- 265 CODES/STANDARDS-CSA/CMVSS
- 1B1 CODES/STANDARDS USA

1B1 265 78J

FIRST USED	14 J32H	
TITLE:	DO NOT SCALE DRAWING	
	WIRING INSTL-BODY,110V	
SHEET 5	PART NO 186551	REV

FOR ELECTRICAL TORQUE SPECIFICATIONS SEE DWG NO. 128783-01-000

FOR ELECTRICAL CALLOUTS SEE DWG NO. 121339-01-000

* 186551 * A

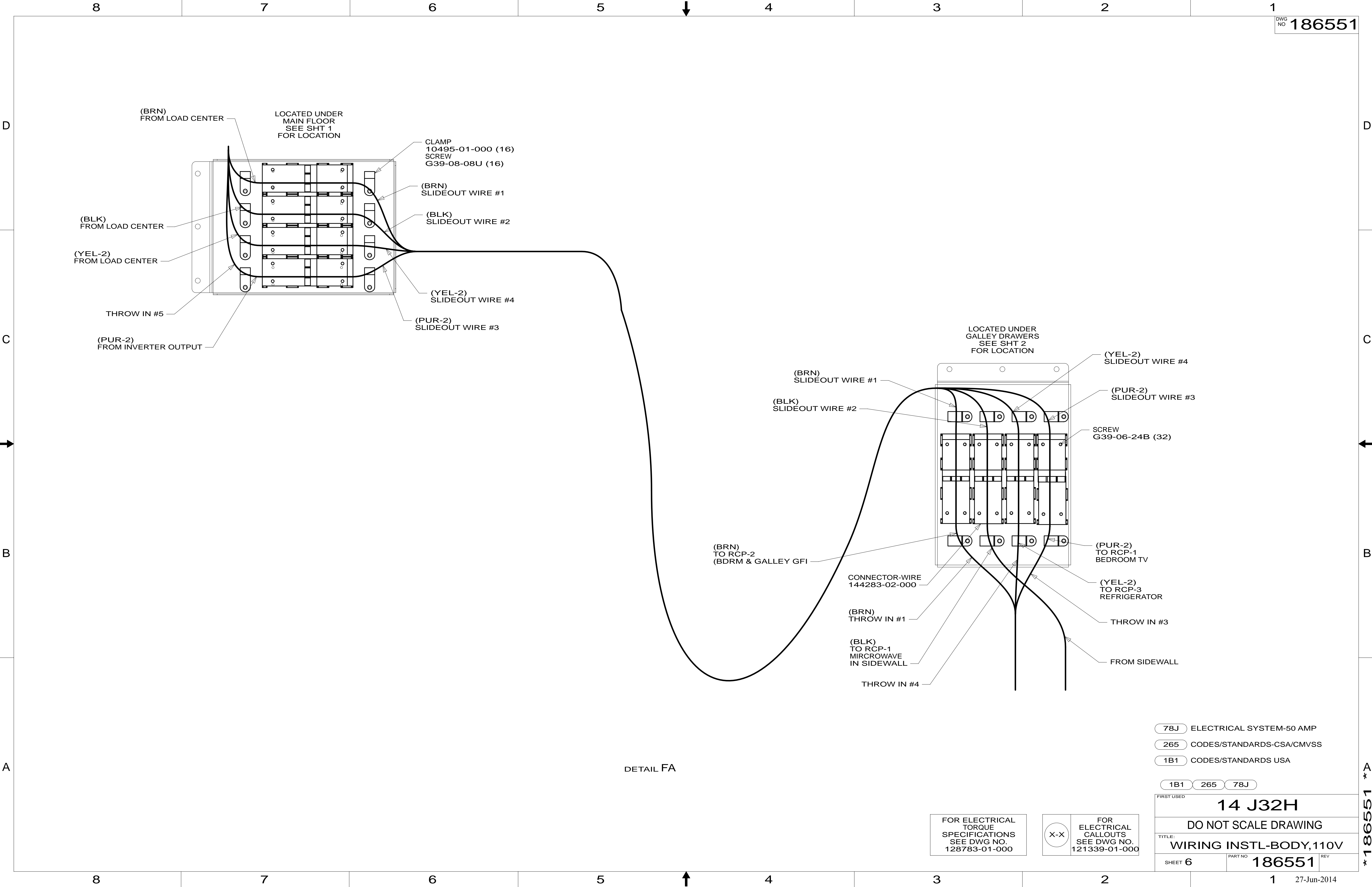

DETAIL FA

- 78J ELECTRICAL SYSTEM-50 AMP
- 265 CODES/STANDARDS-CSA/CMVSS
- 1B1 CODES/STANDARDS USA

1B1 265 78J

FIRST USED 14 J32H

DO NOT SCALE DRAWING

TITLE: WIRING INSTL-BODY, 110V

SHEET 6 PART NO 186551 REV

FOR ELECTRICAL TORQUE SPECIFICATIONS SEE DWG NO. 128783-01-000

FOR ELECTRICAL CALLOUTS SEE DWG NO. 121339-01-000

* 186551 * A

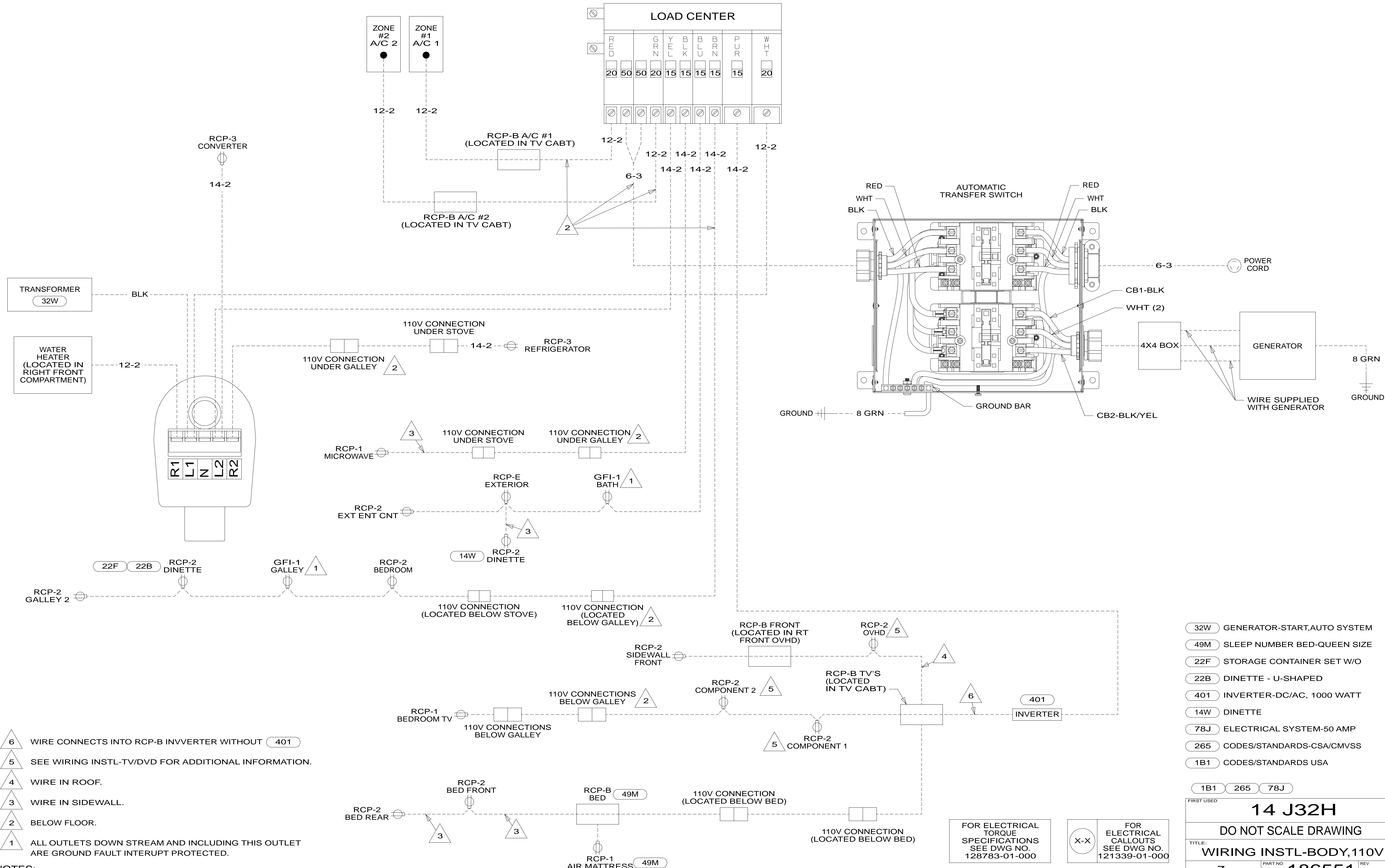

- NOTES:
- 6 WIRE CONNECTS INTO RCP-B INVERTER WITHOUT 401
 - 5 SEE WIRING INSTL-TV/DVD FOR ADDITIONAL INFORMATION.
 - 4 WIRE IN ROOF.
 - 3 WIRE IN SIDEWALL.
 - 2 BELOW FLOOR.
 - 1 ALL OUTLETS DOWN STREAM AND INCLUDING THIS OUTLET ARE GROUND FAULT INTERRUPT PROTECTED.

- 32W GENERATOR-START,AUTO SYSTEM
- 49M SLEEP NUMBER BED-QUEEN SIZE
- 22F STORAGE CONTAINER SET W/O
- 22B DINETTE - U-SHAPED
- 401 INVERTER-DC/AC, 1000 WATT
- 14W DINETTE
- 78J ELECTRICAL SYSTEM-50 AMP
- 265 CODES/STANDARDS-CSA/CMVSS
- 1B1 CODES/STANDARDS USA

FIRST USED

14 J32H

DO NOT SCALE DRAWING

TITLE: **WIRING INSTL-BODY, 110V**

SHEET 7 PART NO **186551** REV

27-Jun-2014

FOR ELECTRICAL TORQUE SPECIFICATIONS SEE DWG NO. 128783-01-000

FOR ELECTRICAL CALLOUTS SEE DWG NO. 121339-01-000

* 186551 * A