



DANGER

Danger of electrical shock, burns or death. Always remove all power sources before attempting any repair, service or diagnostic work. Power can be present from shore power, generator, inverter or battery. All power sources must be disabled and secured before performing any service.



CAUTION

If you lack the skills, tools or equipment to perform diagnostic or repair work leave such work to an authorized Winnebago Industries dealer or other qualified shop.

DRAWING NO.	MODEL	SHEETS
184233-01	727K	1,2,3,7
184233-02	730J	4,5,6

RELEASE	REV/DATE	DWG NO	184233
REV ZONE	REVISION RECORD	DATE	DTR-ORIG

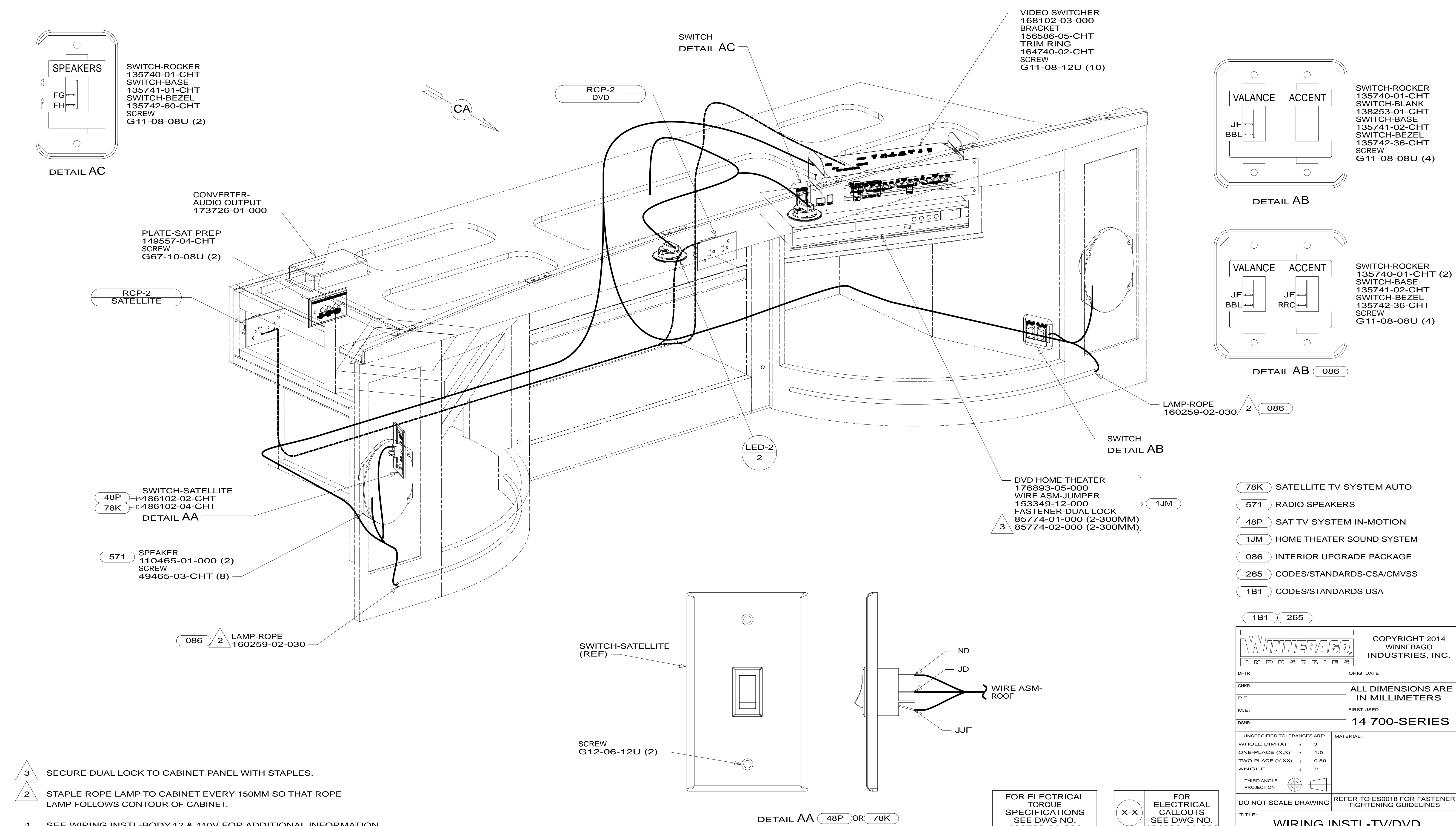

- NOTES:
- SEE WIRING INSTL-BODY,12 & 110V FOR ADDITIONAL INFORMATION.
- 3 SECURE DUAL LOCK TO CABINET PANEL WITH STAPLES.
- 2 STAPLE ROPE LAMP TO CABINET EVERY 150MM SO THAT ROPE LAMP FOLLOWS CONTOUR OF CABINET.

- 78K SATELLITE TV SYSTEM AUTO
- 571 RADIO SPEAKERS
- 48P SAT TV SYSTEM IN-MOTION
- 1JM HOME THEATER SOUND SYSTEM
- 086 INTERIOR UPGRADE PACKAGE
- 265 CODES/STANDARDS-CSA/CMVSS
- 1B1 CODES/STANDARDS USA

1B1 265

WINNEBAGO INDUSTRIES, INC. COPYRIGHT 2014

ALL DIMENSIONS ARE IN MILLIMETERS

14 700-SERIES

UNSPECIFIED TOLERANCES ARE:

WHOLE DIM (X)	: 3
ONE-PLACE (X.X)	: 1.5
TWO-PLACE (X.XX)	: 0.50
ANGLE	: 1°

THIRD ANGLE PROJECTION

DO NOT SCALE DRAWING REFER TO ES0018 FOR FASTENER TIGHTENING GUIDELINES

TITLE: **WIRING INSTL-TV/DVD**

SHEET 1 OF 7 PART NO **184233** REV

REF: 1 05-May-2014

FOR ELECTRICAL TORQUE SPECIFICATIONS SEE DWG NO. 128783-01-000

FOR ELECTRICAL CALLOUTS SEE DWG NO. 121339-01-000

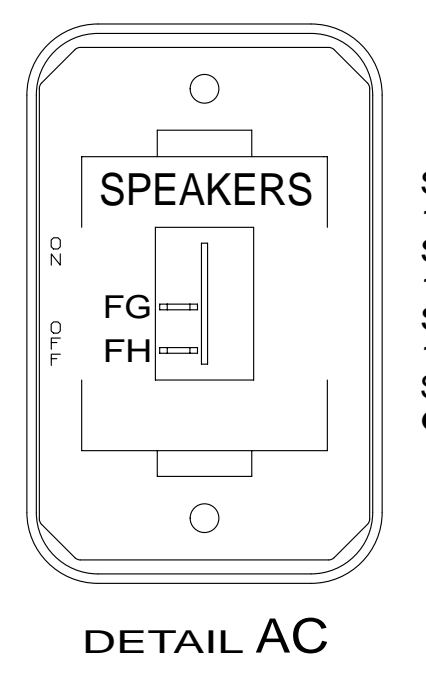
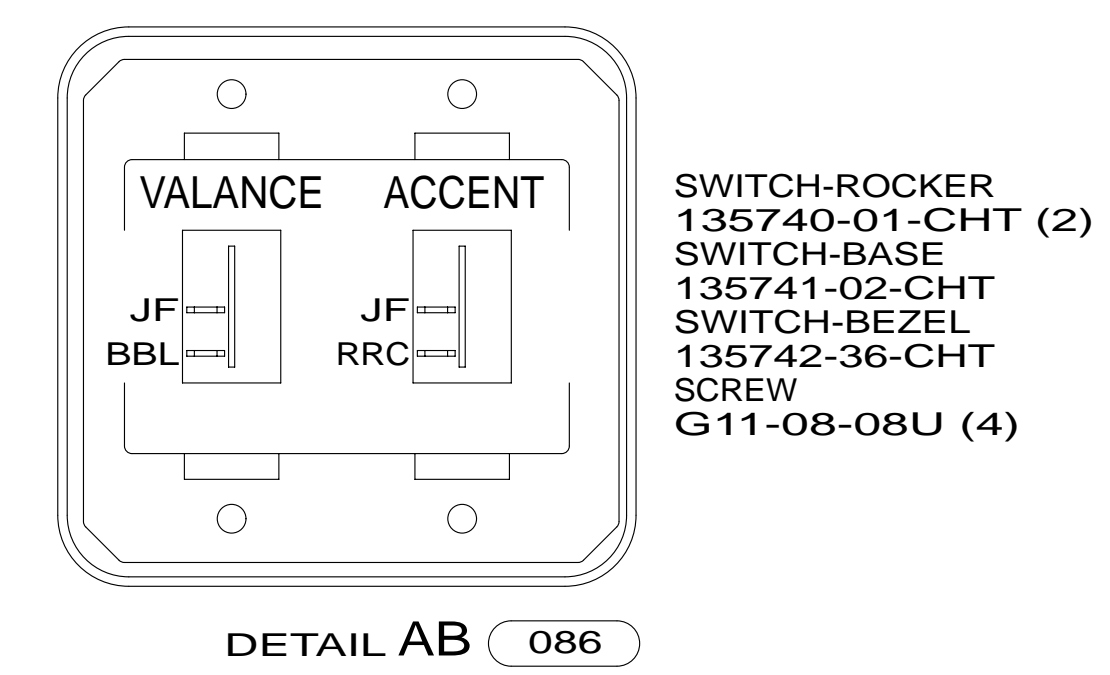
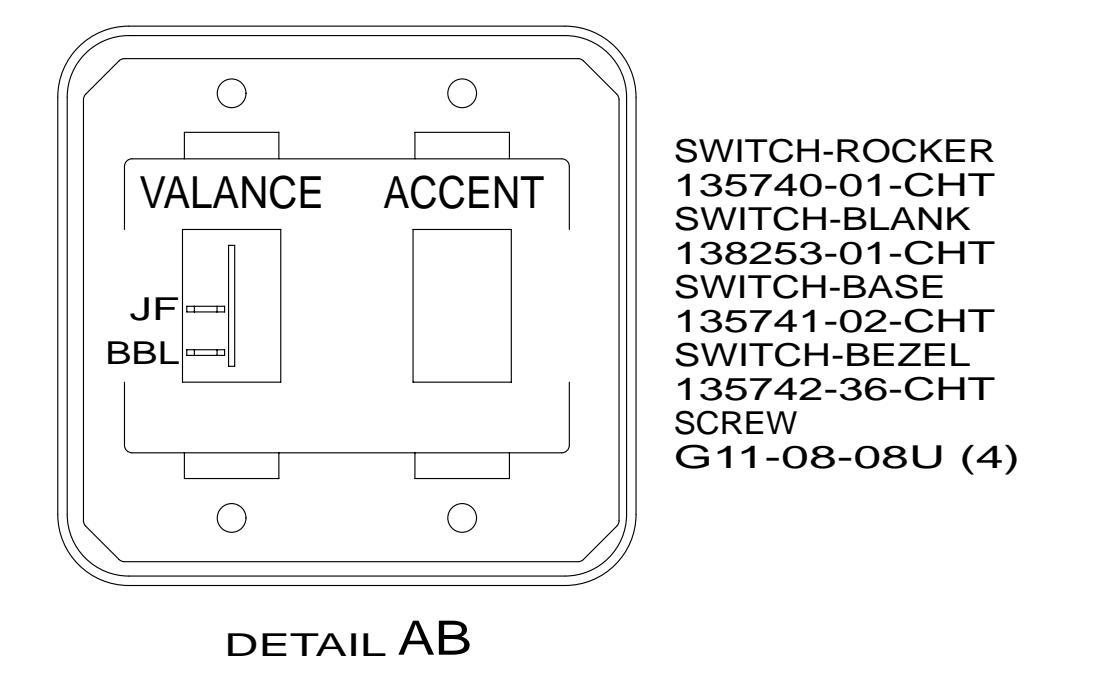
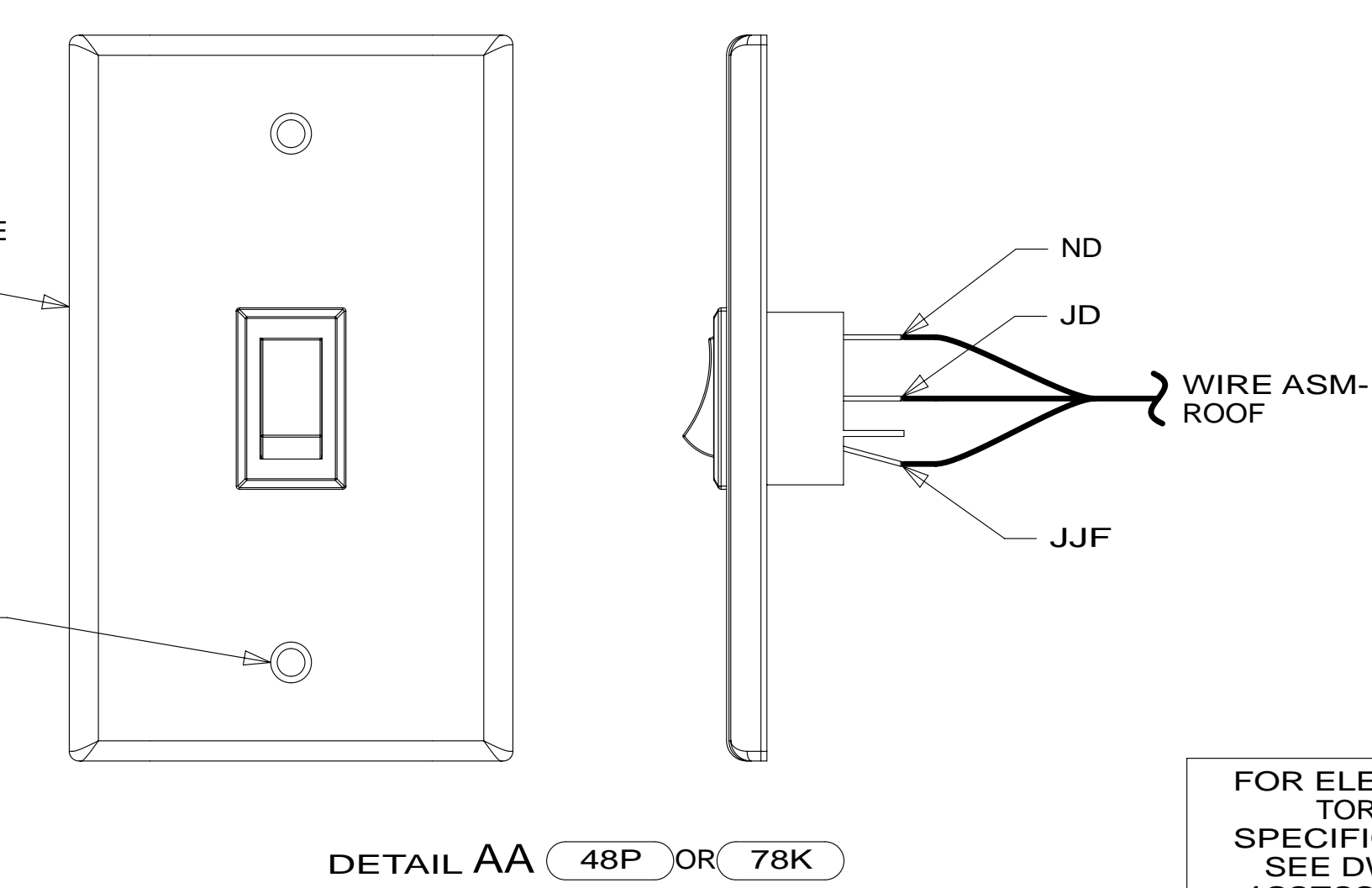

SWITCH-ROCKER 135740-01-CHT
SWITCH-BASE 135741-01-CHT
SWITCH-BEZEL 135742-36-CHT
SCREW G11-08-08U (2)

CONVERTER-AUDIO OUTPUT 173726-01-000

PLATE-SAT PREP 149557-04-CHT
SCREW G67-10-08U (2)

RCP-2 SATELLITE

48P 186102-02-CHT
78K 186102-04-CHT
DETAIL AA

571 SPEAKER 110465-01-000 (2)
SCREW 49465-03-CHT (8)

086 2 LAMP-ROPE 160259-02-030

SWITCH-SATELLITE (REF)

SCREW G12-06-12U (2)

VIDEO SWITCHER 168102-03-000
BRACKET 156586-05-CHT
TRIM RING 164740-02-CHT
SCREW G11-08-12U (10)

SWITCH DETAIL AC

RCP-2 DVD

LED-2 2

SWITCH DETAIL AB

LAMP-ROPE 160259-02-030 2 086

DVD HOME THEATER 176893-05-000
WIRE ASM-JUMPER 153349-12-000
FASTENER-DUAL LOCK 85774-01-000 (2-300MM)
85774-02-000 (2-300MM) 1JM 3

* 184233 * A

TV-26", FLAT
 PANEL LED, HDTV
 179870-02-000
 SCREW
 (SUPPLIED WITH TV)

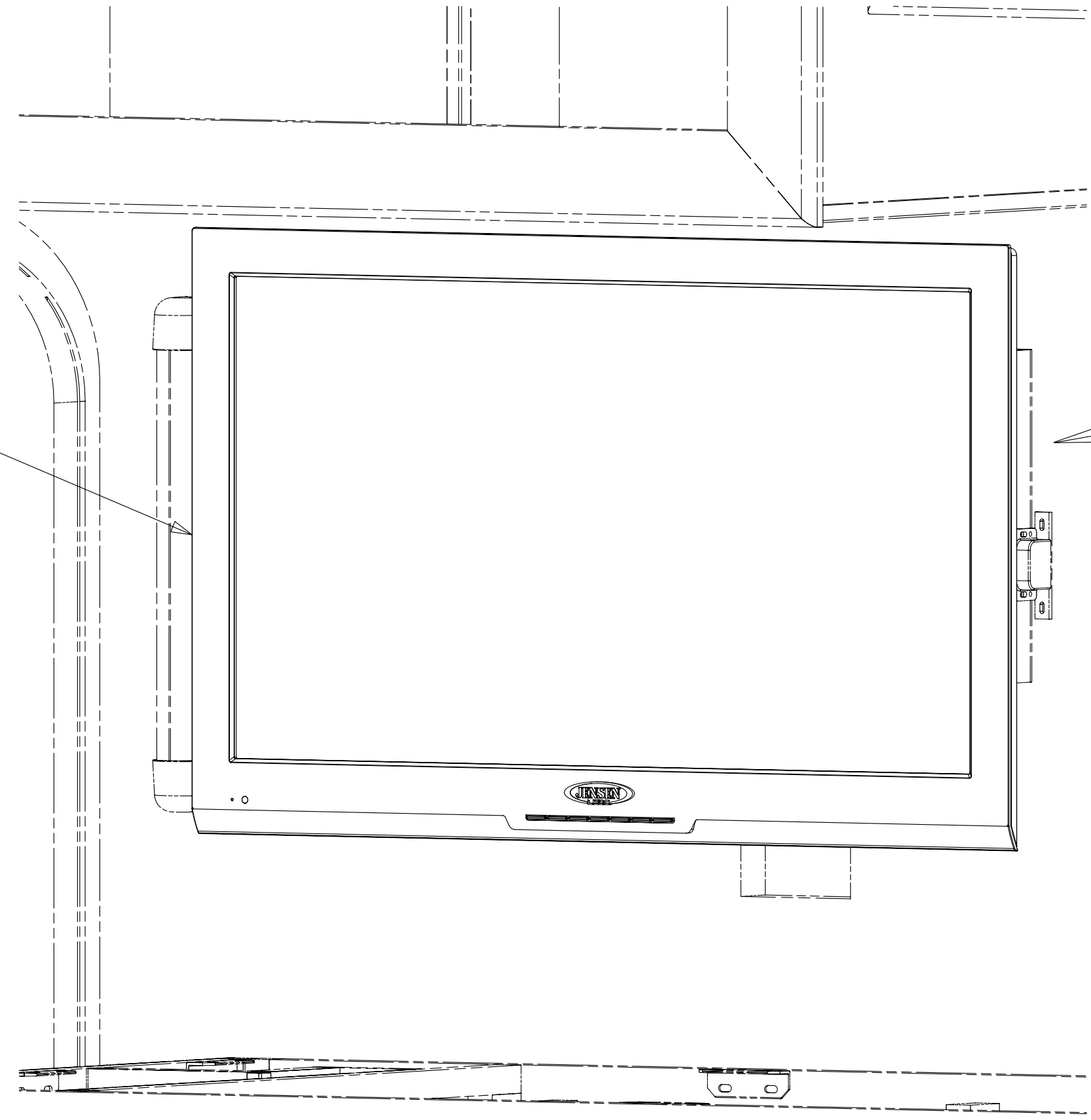

WIRES/CABLES ROUTED
 OUT OF SIDEWALL IN
 THIS AREA

3 CONDUIT-CONVOLUTE
 41953-03-000 (300 MM)
 TIE-WIRE, MOUNT
 155366-01-000
 TIE-WIRE
 8343-03-000

1 TIE-WIRE
 8343-02-000

TAPE-FOAM, DBL COATED
 76322-21-000 (530 MM) (2) 2

TAPE-FOAM, DBL COATED
 76322-21-000 (210 MM) (2) 2

VIEW BA
 (TV NOT SHOWN)

MOUNT TV BRACKET SO
 THAT SLOT IN BRACKET
 LINES UP WITH SLOT
 IN SIDEWALL

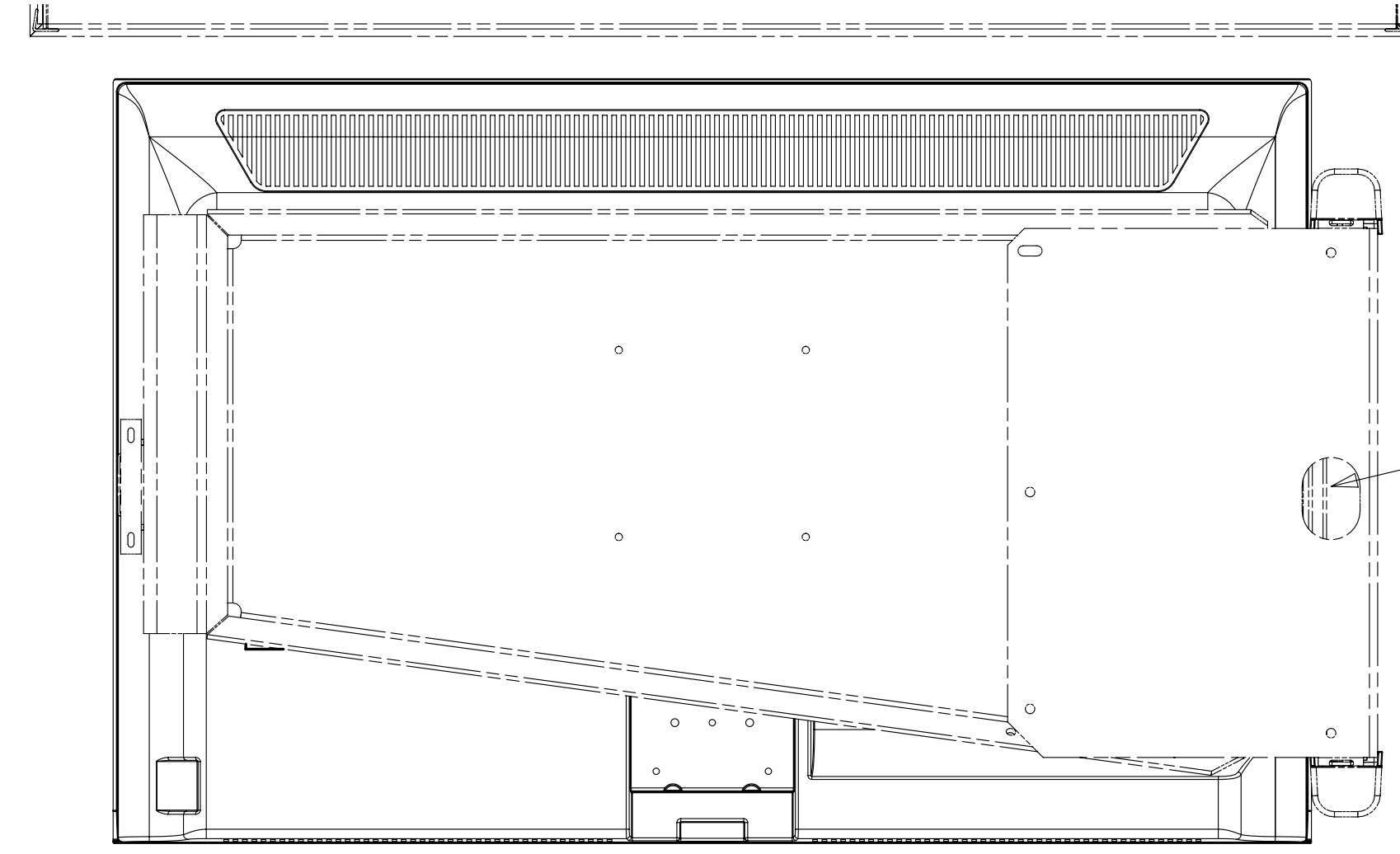

VIEW BB

- NOTES:
- 3 COVER WIRES, COAX, AND RCA-CABLES THAT ARE ROUTED TO THE TV WITH CONVOLUTED TUBING AND SECURE TO TV-SUPPORT WITH TIE-WIRE.
 - 2 CLEAN AND APPLY ADHESIVE PROMOTOR 87211-01-000 TO BOTH SURFACES AND BOND WHERE BRACKET CONTACTS PLASTIC TV CASE.
 - 1 USE HOLES ON PLATE-MOUNTING, TV TO ATTACH WIRE ASM TO PLATE-MOUNTING, TV WITH WIRE TIES.

265 CODES/STANDARDS-CSA/CMVSS

1B1 CODES/STANDARDS USA

1B1 265

FIRST USED
14 700-SERIES

DO NOT SCALE DRAWING

TITLE:
WIRING INSTL-TV/DVD

SHEET 2 PART NO **184233** REV

FOR ELECTRICAL
 TORQUE
 SPECIFICATIONS
 SEE DWG NO.
 128783-01-000

FOR ELECTRICAL
 CALLOUTS
 SEE DWG NO.
 121339-01-000

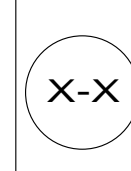

*184233 *A

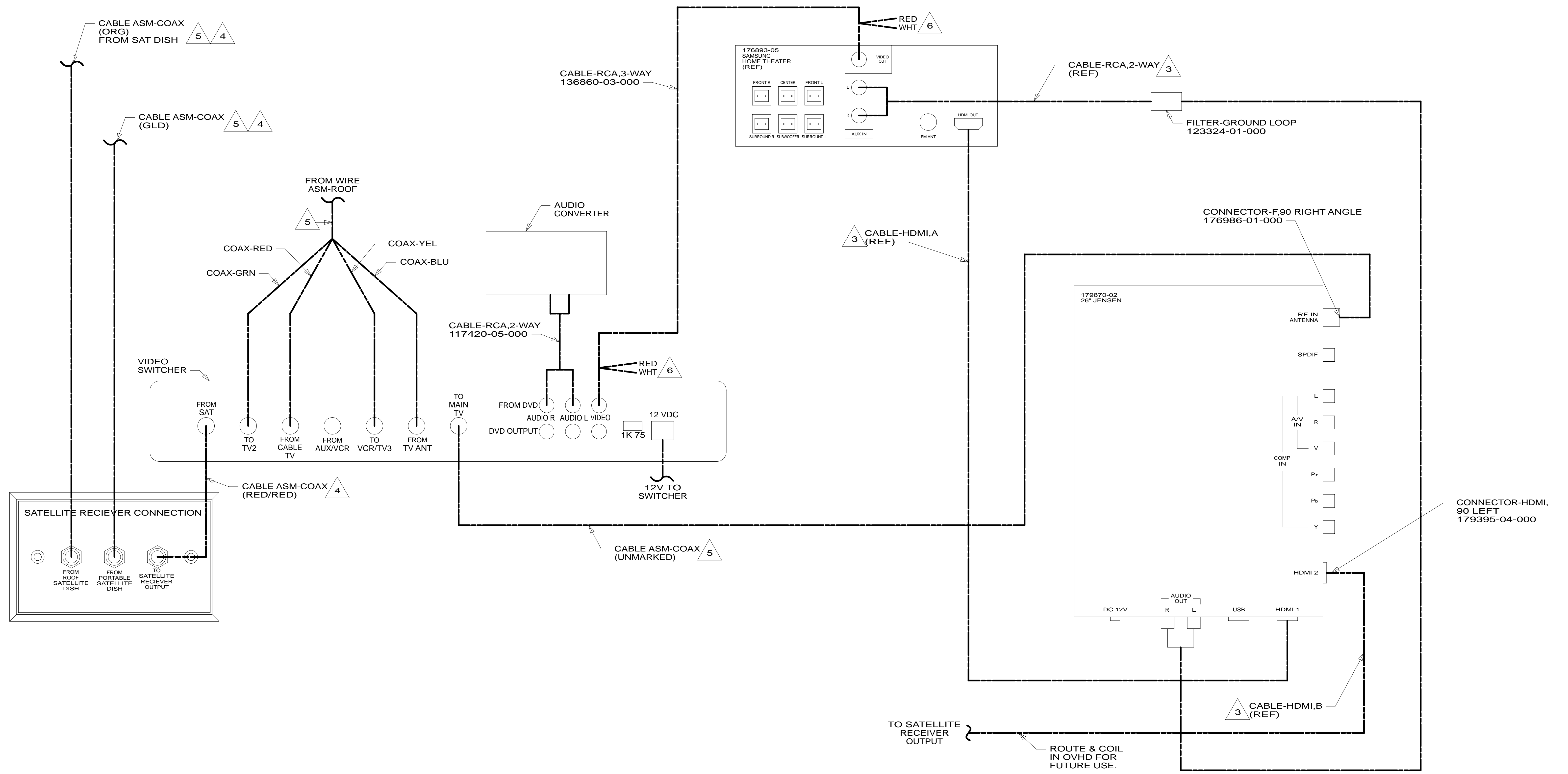

- NOTES:
- 6 RCA CONNECTOR IS NOT USED. TAPE BACK TO CABLE.
 - 5 COAX IS FROM WIRE ASM-ROOF.
 - 4 CONNECTS TO BACK SIDE OF PLATE.
 - 3 CABLE IS ROUTED IN ROOF.
 - 2. ALL CONNECTIONS ARE SHOWN FROM BACKSIDE OF COMPONENTS.
 - 1. SEE WIRING INSTL-BODY,12V FOR ADDITIONAL INFORMATION.

265 CODES/STANDARDS-CSA/CMVSS
 1B1 CODES/STANDARDS USA
 1B1 265

FIRST USED
14 700-SERIES
 DO NOT SCALE DRAWING
 TITLE: **WIRING INSTL-TV/DVD**
 SHEET 3 PART NO **184233** REV
 05-May-2014

FOR ELECTRICAL TORQUE SPECIFICATIONS SEE DWG NO. 128783-01-000

X-X FOR ELECTRICAL CALLOUTS SEE DWG NO. 121339-01-000

* 184233 * A

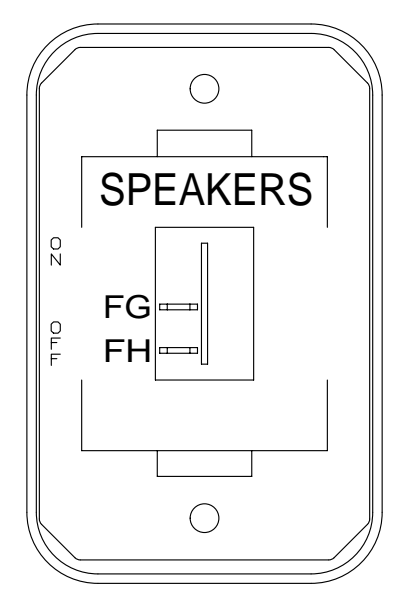

SWITCH-ROCKER
135740-01-CHT
SWITCH-BASE
135741-01-CHT
SWITCH-BEZEL
135742-60-CHT
SCREW
G11-08-08U (2)

DETAIL DC

CONVERTER-AUDIO OUTPUT
173726-01-000

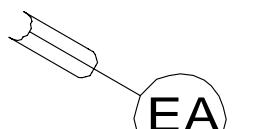

COAX (UNMARKED)
CONNECTS TO TV

SWITCH
DETAIL DC

RCP-2
TV

VIDEO SWITCHER
168102-03-000
BRACKET
156586-05-CHT
TRIM RING
164740-02-CHT
SCREW
G11-08-12U (10)

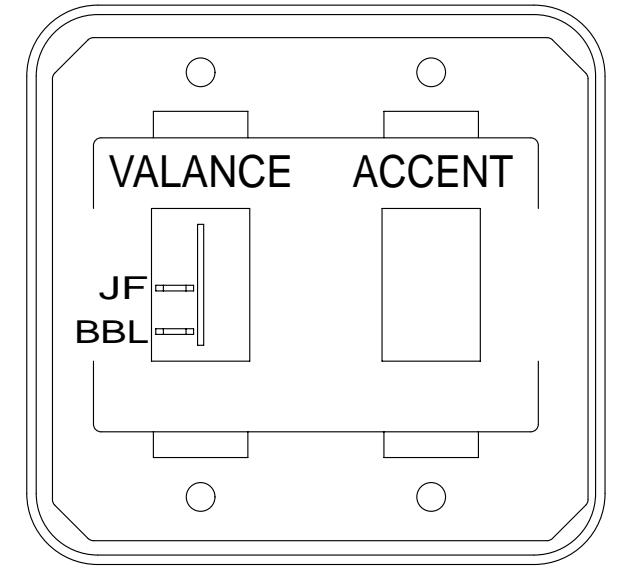

SWITCH-ROCKER
135740-01-CHT
SWITCH-BLANK
138253-01-CHT
SWITCH-BASE
135741-02-CHT
SWITCH-BEZEL
135742-36-CHT
SCREW
G11-08-08U (4)

DETAIL DB

PLATE-SAT PREP
149557-04-CHT
SCREW
G67-10-08U (2)

CONNECTS TO
WIRE ASM-ROOF

RCP-2
SATELLITE

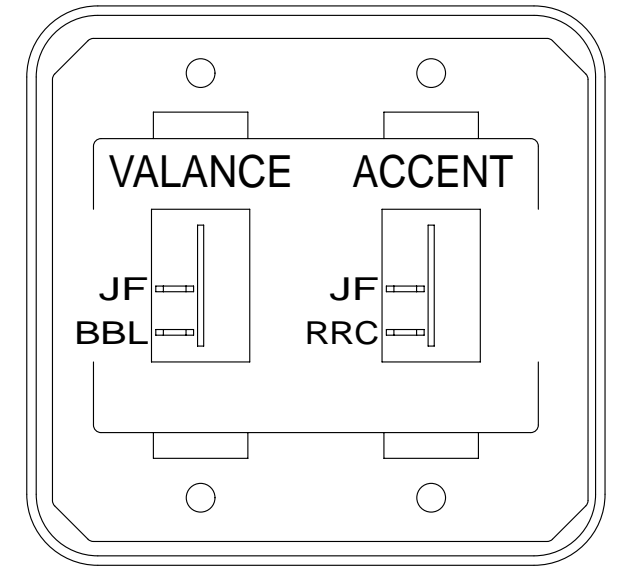

SWITCH-ROCKER
135740-01-CHT (2)
SWITCH-BASE
135741-02-CHT
SWITCH-BEZEL
135742-36-CHT
SCREW
G11-08-08U (4)

DETAIL DB 086

SPEAKER-ROUND
160868-01-CHT (2)
SCREW
G11-08-08B (8)

48P
78K
SWITCH-SATELLITE
186102-02-CHT
186102-04-CHT
DETAIL DA

571
SPEAKER
110465-01-000 (2)
SCREW
49465-03-CHT (8)

086 2
LAMP-ROPE
160259-02-030

TV-28", FLAT
PANEL ELED, HDTV
186599-01-000
SCREW
OMG02B-04-010 (2)
(STAND SUPPORT)
SCREW
MAIN TV SUPPORT
SUPPLIED WITH TV

LED-2
2

SPEAKER-ROUND
179783-01-CHT
SCREW
G1208-12-170 (4)

LAMP-ROPE
160259-02-030 2 086

SWITCH
DETAIL DB

DVD HOME THEATER
176893-05-000
WIRE ASM-JUMPER
153349-12-000
FASTENER-DUAL LOCK
85774-01-000 (2-300MM)
85774-02-000 (2-300MM)

1JM

- 78K SATELLITE TV SYSTEM AUTO
- 571 RADIO SPEAKERS
- 48P SAT TV SYSTEM IN-MOTION
- 1JM HOME THEATER SOUND SYSTEM
- 086 INTERIOR UPGRADE PACKAGE
- 61E TV(FRONT)-26" COLOR STEREO
- 265 CODES/STANDARDS-CSA/CMVSS
- 1B1 CODES/STANDARDS USA

1B1 265 61E

FIRST USED
14 700-SERIES

DO NOT SCALE DRAWING

TITLE:
WIRING INSTL-TV/DVD

SHEET 4 PART NO **184233** REV

3 SECURE DUAL LOCK TO CABINET PANEL WITH STAPLES.

2 STAPLE ROPE LAMP TO CABINET EVERY 150MM SO THAT ROPE LAMP FOLLOWS CONTOUR OF CABINET.

1. SEE WIRING INSTL-BODY,12 & 110V FOR ADDITIONAL INFORMATION.

NOTES:

SWITCH-SATELLITE
(REF)

SCREW
G12-06-12U (2)

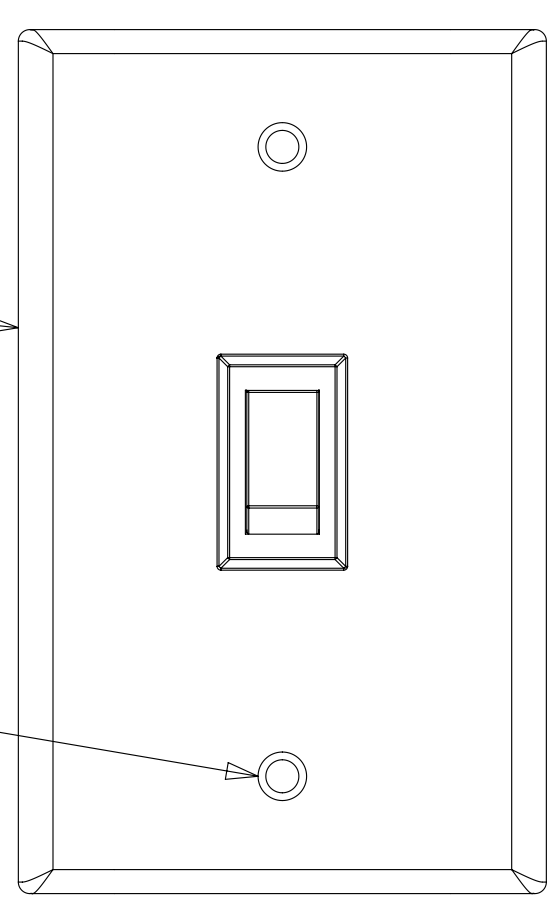

DETAIL DA 48P OR 78K

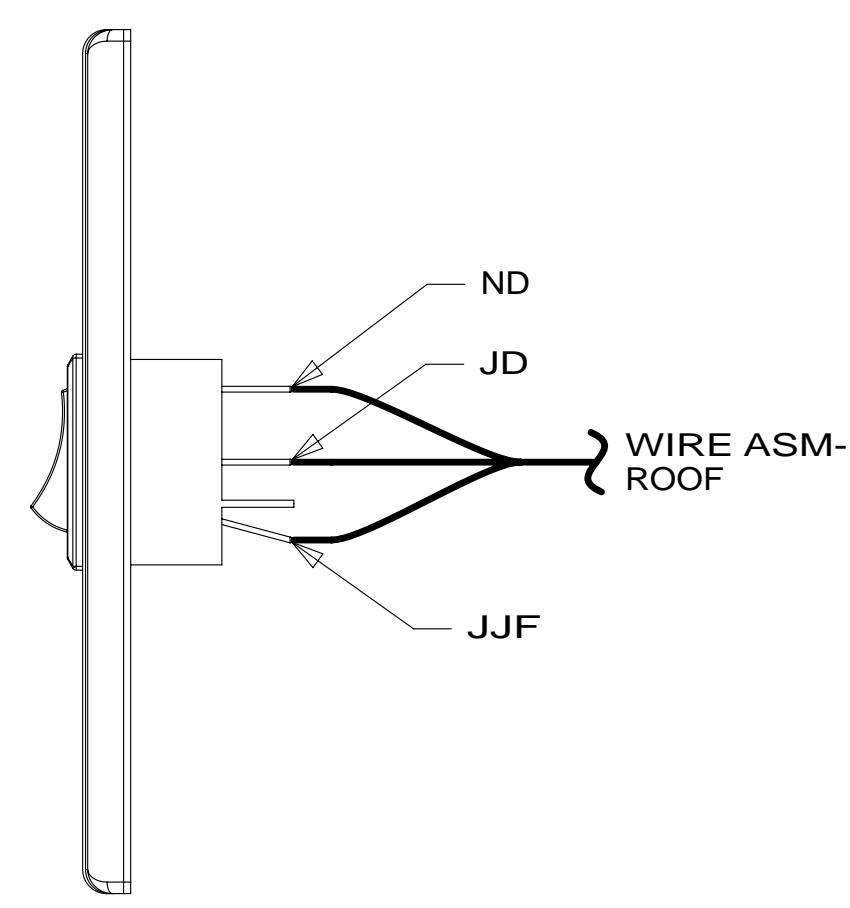

FOR ELECTRICAL
TORQUE
SPECIFICATIONS
SEE DWG NO.
128783-01-000

FOR
ELECTRICAL
CALLOUTS
SEE DWG NO.
121339-01-000

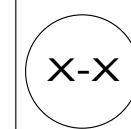

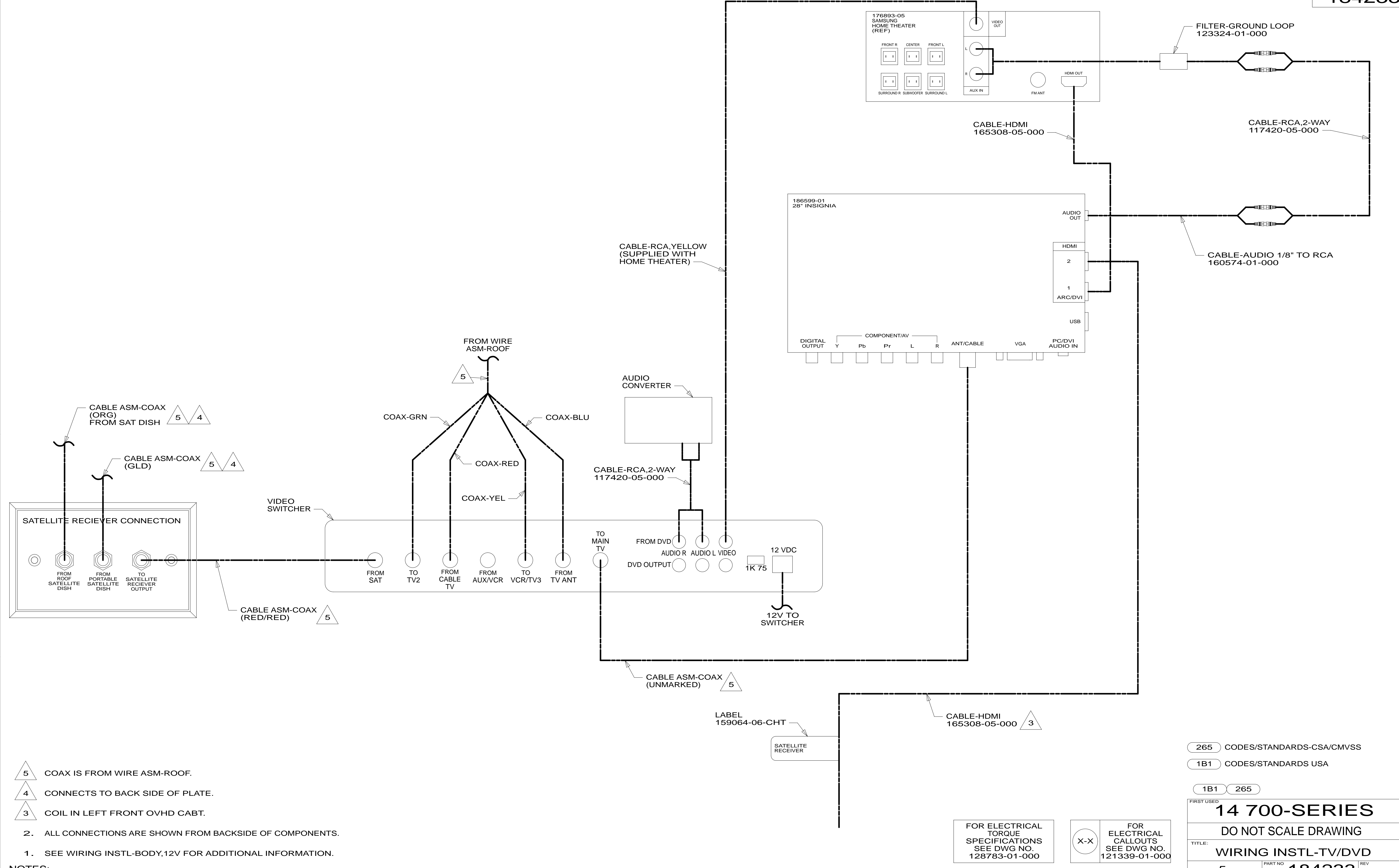

- 5 COAX IS FROM WIRE ASM-ROOF.
- 4 CONNECTS TO BACK SIDE OF PLATE.
- 3 COIL IN LEFT FRONT OVHD CABT.

- 2. ALL CONNECTIONS ARE SHOWN FROM BACKSIDE OF COMPONENTS.
- 1. SEE WIRING INSTL-BODY, 12V FOR ADDITIONAL INFORMATION.

NOTES:

- 265 CODES/STANDARDS-CSA/CMVSS
- 1B1 CODES/STANDARDS USA
- 1B1 265

FIRST USED
14 700-SERIES

DO NOT SCALE DRAWING

TITLE: **WIRING INSTL-TV/DVD**

SHEET 5 PART NO **184233** REV

FOR ELECTRICAL TORQUE SPECIFICATIONS SEE DWG NO. 128783-01-000

FOR ELECTRICAL CALLOUTS SEE DWG NO. 121339-01-000

* 184233 * A

TV-22". FLAT PANEL LED,HDTV
 180602-02-000
 SCREW
 OMG02B-04-012 (4)
 WASHER
 E11-10-00B (4)
 DETAIL FA

TV SWITCH
 (REF)

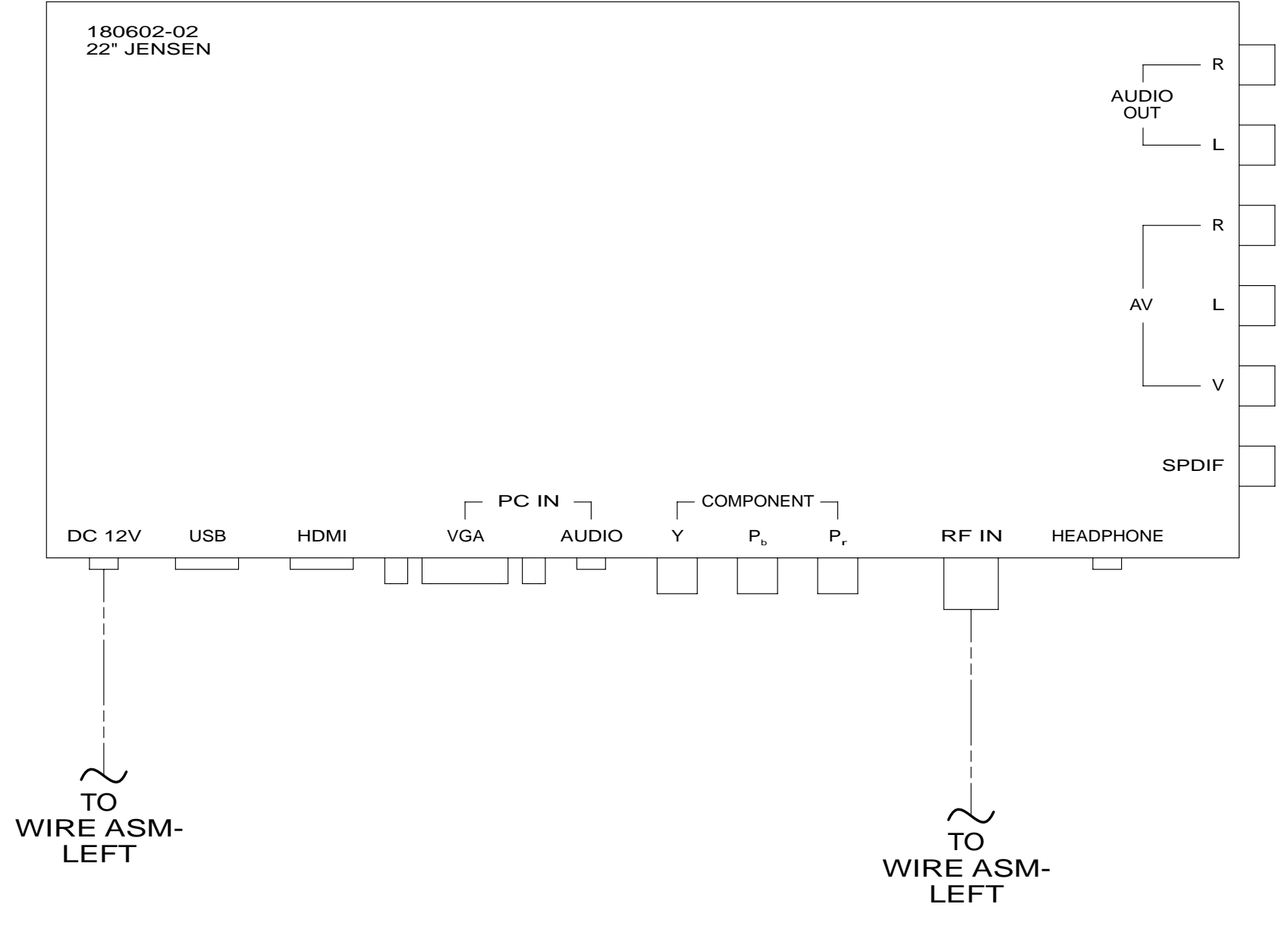
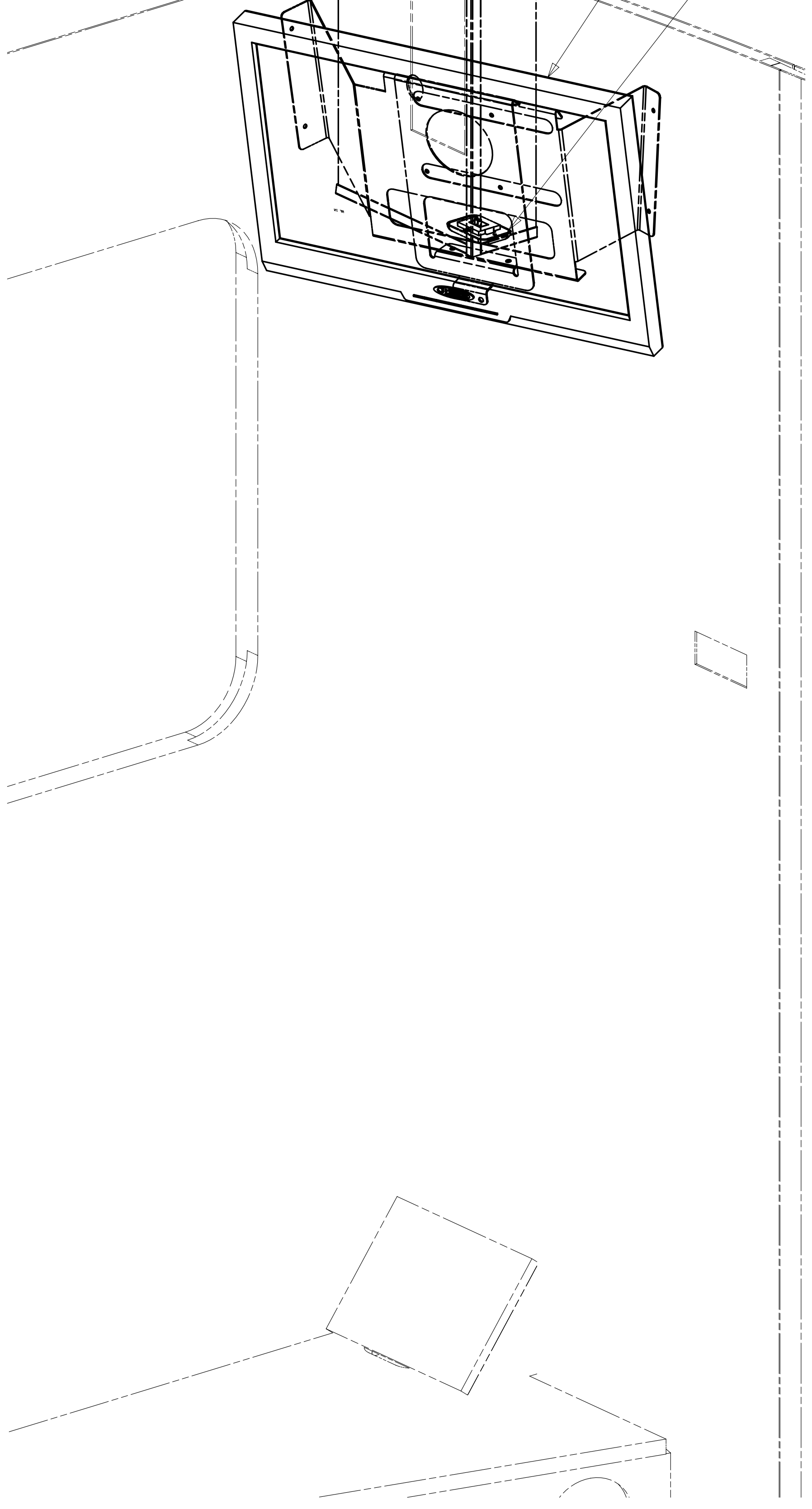

DETAIL FA

- 68B TV (REAR)DC 22" LCD W/REMOTE
- 265 CODES/STANDARDS-CSA/CMVSS
- 1B1 CODES/STANDARDS USA

1B1 265 68B

FIRST USED **14 700-SERIES**

DO NOT SCALE DRAWING

TITLE: **WIRING INSTL-TV/DVD**

SHEET 6 PART NO **184233** REV

FOR ELECTRICAL
 TORQUE
 SPECIFICATIONS
 SEE DWG NO.
 128783-01-000

X-X
 FOR
 ELECTRICAL
 CALLOUTS
 SEE DWG NO.
 121339-01-000

*184233 *A

TV-22" FLAT PANEL LED,HDTV
180602-02-000
DETAIL GA

TV SWITCH
(REF)

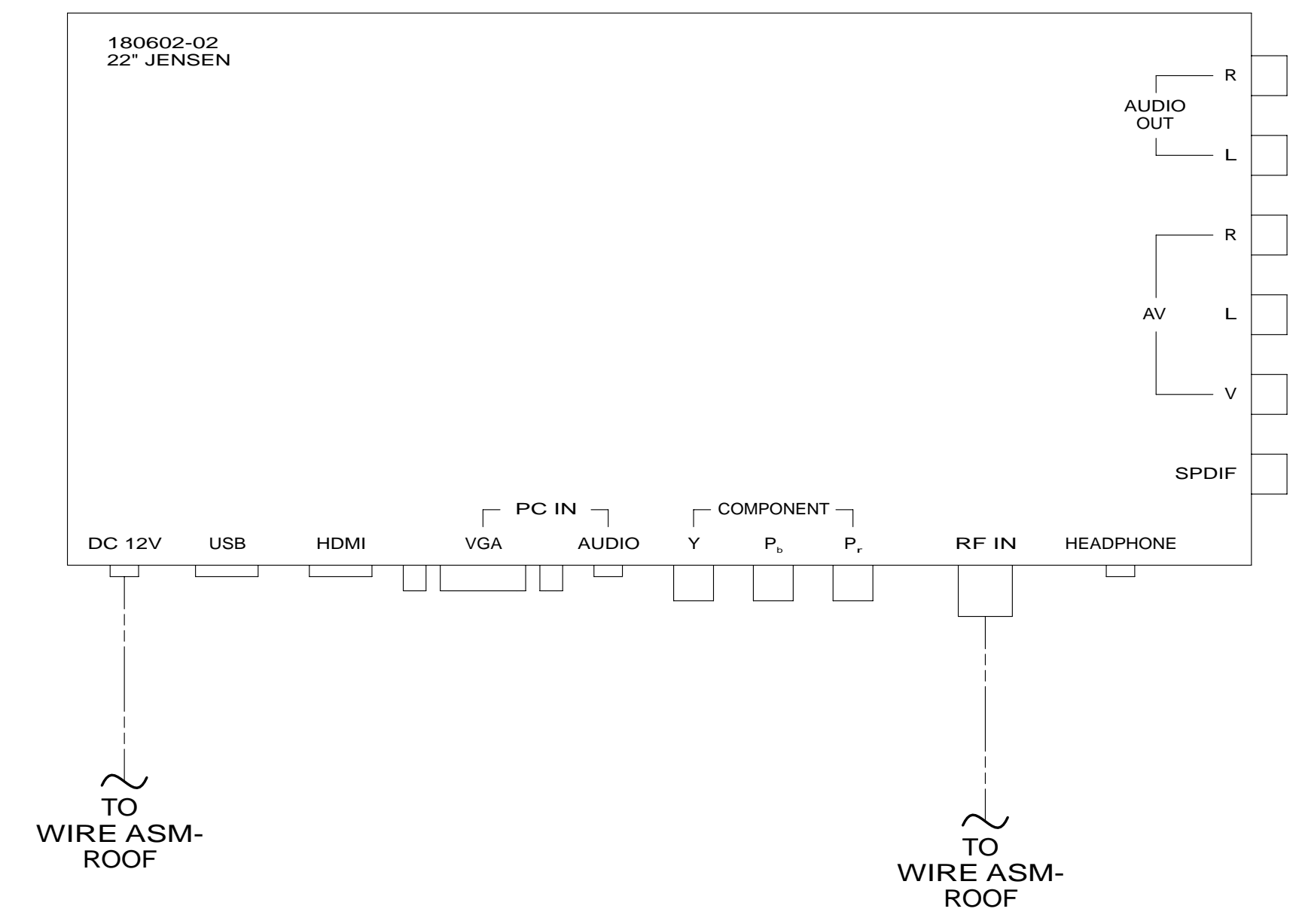
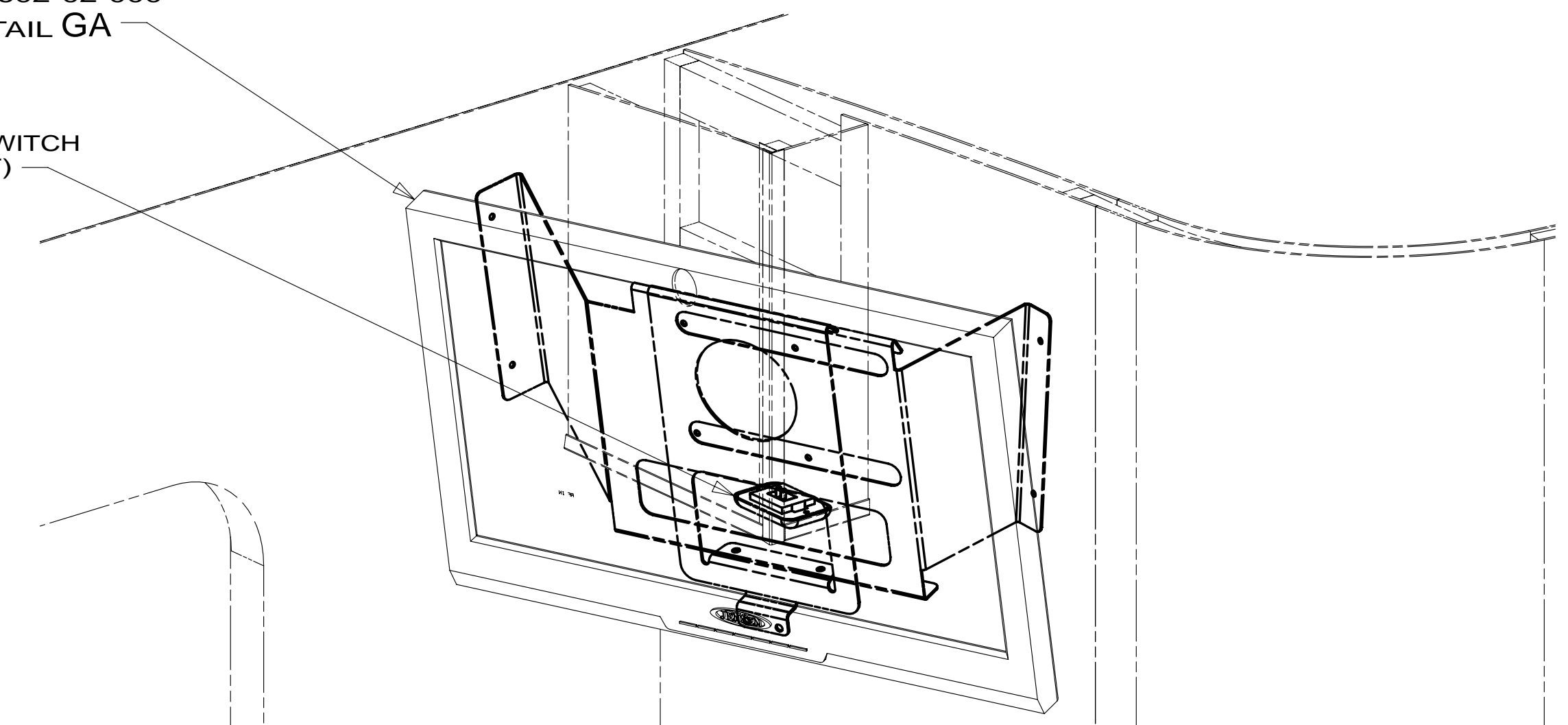

DETAIL GA

- 68B TV (REAR)DC 22" LCD W/REMOTE
- 265 CODES/STANDARDS-CSA/CMVSS
- 1B1 CODES/STANDARDS USA

1B1 265 68B

FIRST USED
14 700-SERIES

DO NOT SCALE DRAWING

TITLE:
WIRING INSTL-TV/DVD

SHEET 7 PART NO **184233** REV

FOR ELECTRICAL
TORQUE
SPECIFICATIONS
SEE DWG NO.
128783-01-000

X-X
FOR
ELECTRICAL
CALLOUTS
SEE DWG NO.
121339-01-000

*184233 *A