



























DANGER

Danger of electrical shock, burns or death. Always remove all power sources before attempting any repair, service or diagnostic work. Power can be present from shore power, generator, inverter or battery. All power sources must be disabled and secured before performing any service.



CAUTION

If you lack the skills, tools or equipment to perform diagnostic or repair work leave such work to an authorized Winnebago Industries dealer or other qualified shop.

		S40FD	S40KD	S40TD
RED	12-UL	136135-07-063	136135-07-063	136135-07-120
	12-CA	136136-07-063	136136-07-063	136136-07-120
MAIN	4-3 UL	136141-01-030	136141-01-030	136141-01-110
	4-3 CA	136142-01-030	136142-01-030	136142-01-110
GRN	12-UL	136135-08-063	136135-08-063	136135-08-120
	12-CA	136136-08-063	136136-08-063	136136-08-120
INVERTER CHARGER MAIN	10-UL	136137-01-032	136137-01-032	136137-01-121
	10-CA	136138-01-032	136138-01-032	136138-01-121
YEL	14-UL	136131-05-055	136131-05-060	136131-05-135
	14-CA	136134-05-055	136134-05-060	136134-05-135
YEL-2	14-UL	136131-13-060 	136131-13-076	136131-13-135 
	14-CA	136134-13-060 	136134-13-076	136134-13-135 
YEL-3	14-UL	136131-17-020	136131-17-020	136131-17-020
	14-CA	136134-17-020	136134-17-020	136134-17-020
GLD	12-UL	136135-10-075	136135-10-075	136135-10-025
	12-CA	136136-10-075	136136-10-075	136136-10-025
WHT	12 UL	136135-09-060	136135-09-040	136135-09-040
	12 CA	136136-09-060	136136-09-040	136136-09-040
INVERTER CHARGER SUB MAIN	10-UL	136137-01-032	136137-01-032	136137-01-121
	10-CA	136138-01-032	136138-01-032	136138-01-121
BLU	14-UL	136131-02-130 	136131-02-110	136131-02-220 
	14-CA	136134-02-130 	136134-02-110	136134-02-220 
	14-UL	-----	-----	136131-02-266 
	14-CA	-----	-----	136134-02-266 
BRN	14-UL	136131-03-170 	136131-03-140 	136131-03-222
	14-CA	136134-03-170 	136134-03-140 	136134-03-222
PUR	14-UL	136131-04-120	136131-04-085	136131-04-098 
	14-CA	136134-04-120	136134-04-085	136134-04-098 
ORG	14-UL	136131-16-180	136131-16-180	136131-16-337
	14-CA	136134-16-180	136134-16-180	136134-16-337
BLK	14-UL	136131-06-070 	136131-06-074 	136131-06-155
	14-CA	136134-06-070 	136134-06-074 	136134-06-155
SIL	14-UL	136131-11-065	136131-11-074 	136131-11-160
	14-CA	136134-11-065	136134-11-074 	136134-11-160
GRY	14-UL	136131-15-060 	----	----
	14-CA	136134-15-060 	----	----
GROUND MAIN		136145-01-025	136145-01-025	136145-01-107
GROUND SUB MAIN		136145-01-025	136145-01-025	136145-01-107
GROUND ATS		136145-01-007	136145-01-007	136145-01-007
GROUND INVERTER		136145-01-014	136145-01-014	136145-01-010
CABLE ASM. GEN.		136148-02-122	136148-02-122	136148-02-085
CONDUIT ASM-CENTRAL A/C		151704-01-038	151704-01-038	151704-01-028

22T

54E 21M

11F

11F

11E

11E

1

1

1

1

1

1

1

1

1

1

1













1

1

1

214

14C

-  REFRIG/FRZR-PORTABLE WITHOUT
 -  REFRIGERATOR/FREEZER PORTABL
 -  FIREPLACE-ELECTRIC
 -  CODES/STANDARDS - CSA/CMVSS
 -  DISHWASHER DRAWER STYLE
 -  WASHER/DRYER
 -  VACUUM SYSTEM - CENTRAL
 -  DISHWASHER/BUILT-IN
 -  WASHER/DRYER PREP
 -  CODES/STANDARDS - USA
-  

WINNEBAGO COPYRIGHT 2006 WINNEBAGO INDUSTRIES, INC.

DFTR	ORIG. DATE
CHKR	ALL DIMENSIONS ARE IN MILLIMETERS
P.E.	
M.E.	FIRST USED
DSNR	07 S-SERIES
UNSPECIFIED TOLERANCES ARE:	
WHOLE DIM (X)	: 3
ONE-PLACE (X.X)	: 1.5
TWO-PLACE (X.XX)	: 0.50
ANGLE	: 1°
THIRD ANGLE PROJECTION 	
DO NOT SCALE DRAWING	
TITLE: LOAD CENTER/ATS ASM	
SHEET 1 OF 3	PART NO 156183 REV
REF:	1 5/15/2007

NOTES:  SEE DETAIL BA FOR CONNECTOR INSTALLATION.

8		7		6		5	
		S40FD		S40KD		S40TD	
SLIDEOUT #1 WIRE #1		136151-03-042	136151-03-050	136151-03-030			
SLIDEOUT #1 WIRE #2		136151-06-042	----	136151-13-030			
SLIDEOUT #1 WIRE #3		136151-11-026	----	----			
SLIDEOUT #2 WIRE #1		136151-04-020	136151-04-020	136151-04-022			
SLIDEOUT #3 WIRE #1		136151-02-060	136151-02-035	----			
SLIDEOUT #3 WIRE #2		136151-13-045	136151-06-035	----			
SLIDEOUT #3 WIRE #3		136151-02-018	136151-11-035	214			
SLIDEOUT #3 WIRE #4		136151-15-070	136151-02-050	14C			
SLIDEOUT #4 WIRE #1		136151-04-035	----	----			
THROW IN WIRE #1	14-UL	----	136131-02-003	136131-03-080			
THROW IN WIRE #1	14-CA	----	136134-02-003	136134-03-080			
THROW IN WIRE #2	14-UL	136131-04-040	136131-02-055	136131-04-050			
THROW IN WIRE #2	14-CA	136134-04-040	136134-02-055	136134-04-050			
THROW IN WIRE #3	14-UL	136131-11-006	136131-11-010	136131-13-015	214		
THROW IN WIRE #3	14-CA	136134-11-006	136134-11-010	136134-13-015	214		
THROW IN WIRE #4	14-UL	136131-02-025	136131-04-005	----			
THROW IN WIRE #4	14-CA	136134-02-025	136134-04-005	----			
THROW IN WIRE #5	14-UL	136131-04-080	136131-06-003	----			
THROW IN WIRE #5	14-CA	136134-04-080	136134-06-003	----			
THROW IN WIRE #6	14-UL	136131-02-060	136131-03-045	----			
THROW IN WIRE #6	14-CA	136134-02-060	136134-03-045	----			
THROW IN WIRE #7	14-UL	136131-03-032	136131-04-066	----			
THROW IN WIRE #7	14-CA	136134-03-032	136134-04-066	----			
THROW IN WIRE #8	14-UL	136131-04-003	136131-02-038	----			
THROW IN WIRE #8	14-CA	136134-04-003	136134-02-038	----			
THROW IN WIRE #9	14-UL	136131-02-025	136131-02-013	----			
THROW IN WIRE #9	14-CA	136134-02-025	136134-02-013	----			
THROW IN WIRE #10	14-UL	136131-15-010	136131-02-050	----			
THROW IN WIRE #10	14-CA	136134-15-010	136134-02-050	----			
THROW IN WIRE #11	14-UL	136131-13-010	136131-03-015	440			
THROW IN WIRE #11	14-CA	136134-13-010	136134-03-015	440			

NOTES:

SEE DETAIL BB FOR CONNECTOR INSTALLATION.

SEE DETAIL BA FOR CONNECTOR INSTALLATION.

SEE DETAIL BC FOR CONNECTOR INSTALLATION.

SEE WIRING INSTL-BODY,110V FOR ADDITIONAL INFORMATION.

SEE DETAIL BD FOR CONNECTOR INSTALLATION.

SEE DETAIL BE FOR CONNECTOR INSTALLATION.

APPLY 300MM OF CONDUIT-CONVOLUTE 41953-05-000 OVER WIRE AT DIMENSION SHOWN AND SECURE BOTH ENDS OF TUBING TO WIRE WITH TAPE 8363-01-000.

		4		3		2		1	
		S40FD		S40KD		S40TD		DWS NO 156183	
THROW IN WIRE #12	14-UL	----	----	----	----	----	----		
THROW IN WIRE #12	14-CA	----	----	----	----	----	----		
THROW IN WIRE #13	14-UL	136131-04-035	136131-02-018	136131-02-018	----	----	----		11E
THROW IN WIRE #13	14-CA	136134-04-035	136134-02-018	136134-02-018	----	----	----		

214

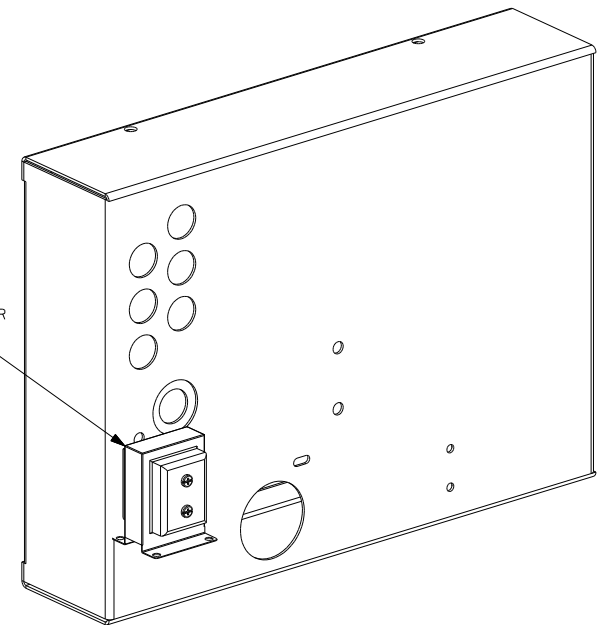
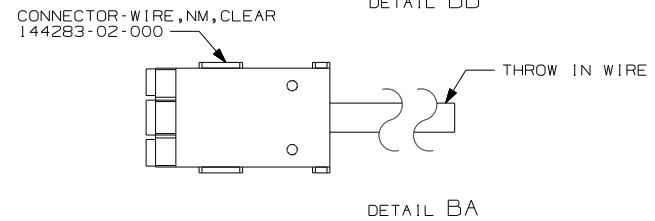
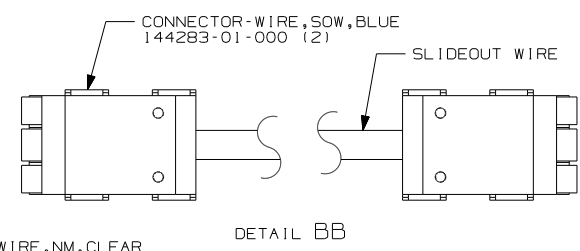
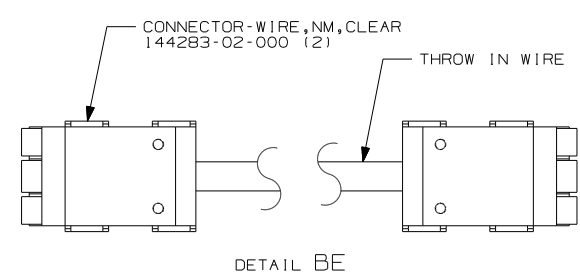
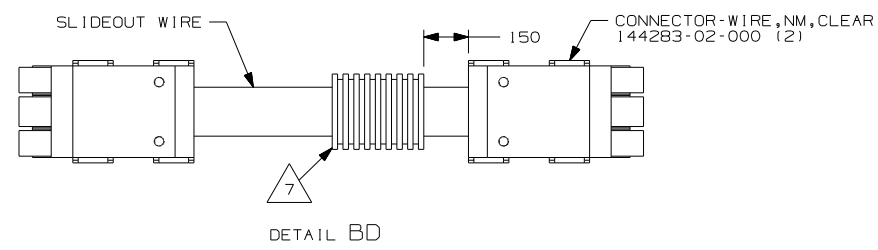

- REFRIGERATOR/FREEZER PORTABL
- LOUNGE CHAIR WITH CABINET
- ENTERTAINMENT CENTR/EXT W/CD
- ENTERTAIN CENTR/EXT TV-DVD
- FIREPLACE-ELECTRIC
- DISHWASHER DRAWER STYLE
- CODES/STANDARDS-CSA/CMVSS
- CODES/STANDARDS-USA

FIRST USED	07 S-SERIES
TITLE	DO NOT SCALE DRAWING
SHEET 2	PART NO 156183 REV

