



DANGER

Danger of electrical shock, burns or death. Always remove all power sources before attempting any repair, service or diagnostic work. Power can be present from shore power, generator, inverter or battery. All power sources must be disabled and secured before performing any service.



CAUTION

If you lack the skills, tools or equipment to perform diagnostic or repair work leave such work to an authorized Winnebago Industries dealer or other qualified shop.

8		7	6	5	4	3	2
		322E	322R	324V	325F	326A	327L
GROUND	8-G	136145-02-015	136145-02-023	136145-02-016	136145-02-020	136145-02-009	136145-02-015
WIRE ASM 110V US		153585-01-000	152286-01-000	155085-01-000	154439-01-000	155288-01-000	154889-01-000
WIRE ASM 110V CA		153585-02-000	152286-02-000	155085-02-000	154439-02-000	155288-02-000	154889-02-000
GENERATOR CABLE ASM	UL	X	X	136137-01-020	136137-01-035	X	X
	CA	X	X	136138-01-020	136138-01-035	X	X

40N 526
40N 526

		329B	329K	331C	331T	332G
GROUND	8-G	136145-02-015	136145-02-012	136145-02-022	136145-02-022	136145-02-012
WIRE ASM 110V US		152752-01-000	150264-01-000	152760-01-000	152760-01-000	153595-01-000
WIRE ASM 110V CA		152752-02-000	150264-02-000	152760-02-000	152760-02-000	153595-02-000
GENERATOR CABLE ASM	UL	136137-01-025	136137-01-025	X	X	136137-01-042
	CA	136138-01-025	136138-01-025	X	X	136138-01-042
THROW-IN #1	UL	X	X	136131-03-006 \triangle_6	136131-03-006 \triangle_6	X
	CA	X	X	136134-03-006 \triangle_6	136134-03-006 \triangle_6	X
THROW-IN #2	UL	X	X	136131-03-065	136131-03-075	X
	CA	X	X	136134-03-065	136134-03-075	X
THROW-IN #3	UL	X	X	136131-03-018	136131-03-018	X
	CA	X	X	136134-03-018	136134-03-018	X

40N 526
40N 526

40B
40B

		723D	726A	729H
GROUND	8-G	136145-02-020	136145-02-014	136145-02-018
WIRE ASM 110V US		154615-01-000	150014-01-000	155310-01-000
WIRE ASM 110V CA		154615-02-000	150014-02-000	155310-02-000
GENERATOR CABLE ASM	UL	136137-01-035	136137-01-038	136137-01-042
	CA	136138-01-035	136138-01-038	136138-01-042
THROW-IN #1	UL	X	136131-03-006	X
	CA	X	136134-03-006	X

40N
40N
40B
40B

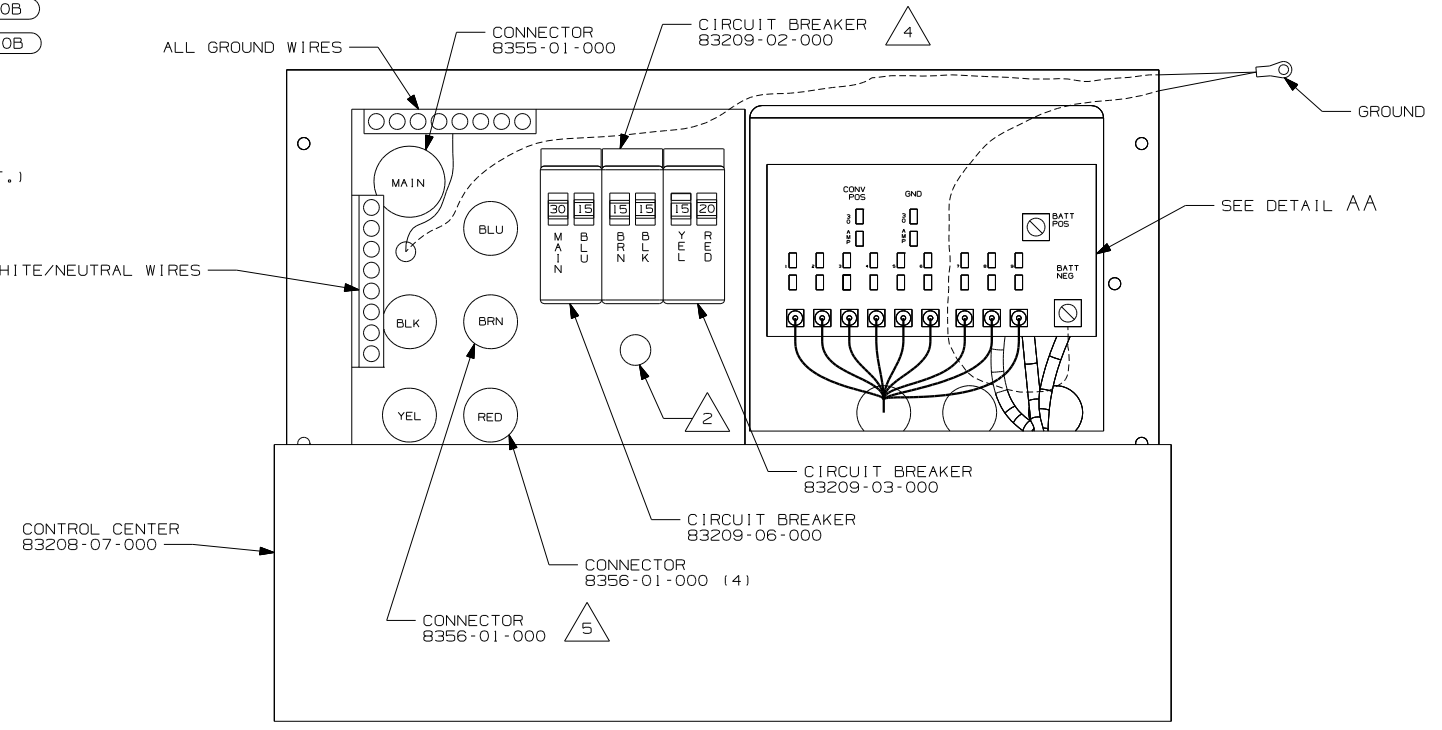
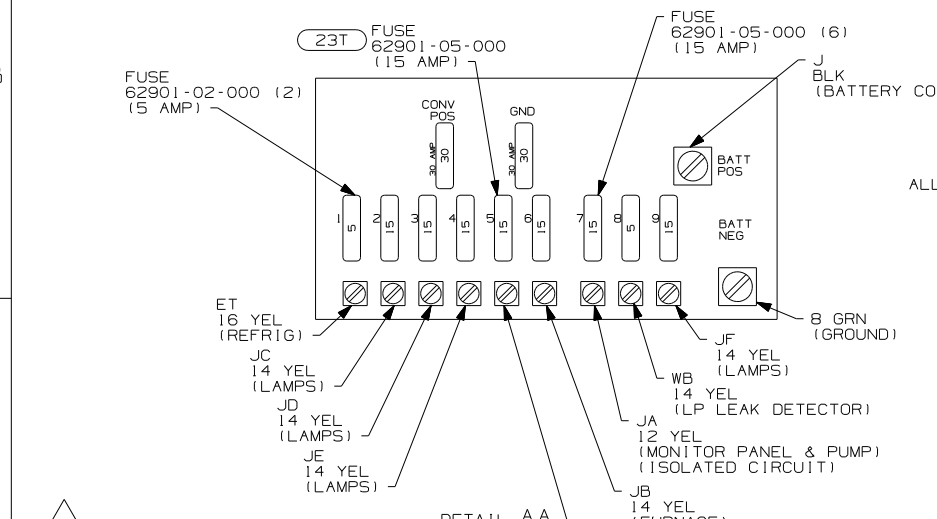
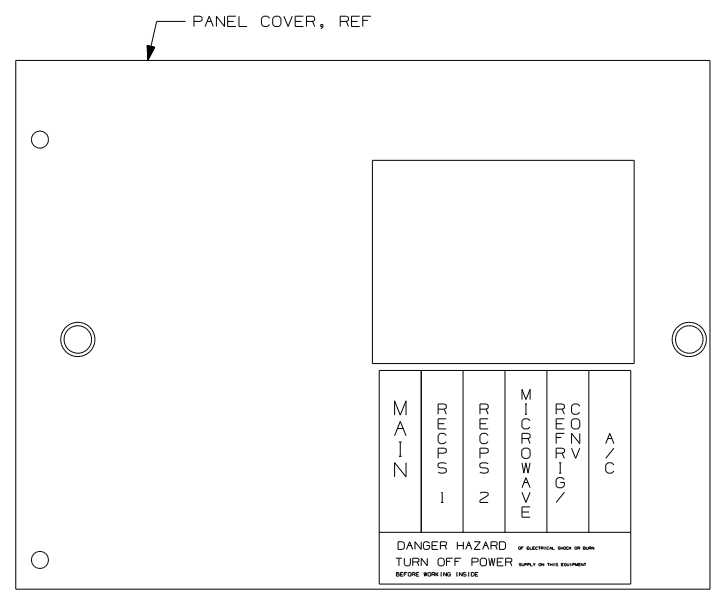

- (23T) DRAINAGE SYSTEM-HEATED
- (40B) INVERTER AC/DC-300 WATT
- (40N) GEN-4.0KW-ONANGAS-MICROQUIET
- (526) GEN-3.6KW ONAN LP MICROQUIET
- (265) CODES/STANDARDS-CSA/CMVSS
- (1B1) CODES/STANDARDS USA

WINNEBAGO		COPYRIGHT 2004 WINNEBAGO INDUSTRIES, INC.	
DFTR	ORIG. DATE		
CHKR	ALL DIMENSIONS ARE IN MILLIMETERS		
P.E.	FIRST USED		
M.E.	06 300/700-SER		
DSNR			
UNSPECIFIED TOLERANCES ARE:		MATERIAL:	
WHOLE DIM (X)	:		
ONE-PLACE (X.X)	:		
TWO-PLACE (X.XX)	:		
ANGLE	:		
THIRD ANGLE PROJECTION			

\triangle_5 NOT USED WITH 322R
 \triangle_4 FOR 322R USE CIRCUIT BREAKER 83209-01-000
 \triangle_3 SEE WIRING INSLT-BODY, 12V FOR ADDITIONAL INFORMATION.
 \triangle_2 SECURE WIRES TO BACKSIDE OF LOAD CENTER WITH WIRE TIE 116673-01-000.
 \triangle_6 FOR CONNECTOR INSTALLATION SEE DETAIL BE

1. ALL GROUND WIRES TO BE COVERED WITH TUBING 8041-02-000.
 NOTES:

(X-X) FOR ELECTRICAL CALLOUTS SEE DWG NO. 121339-01-000

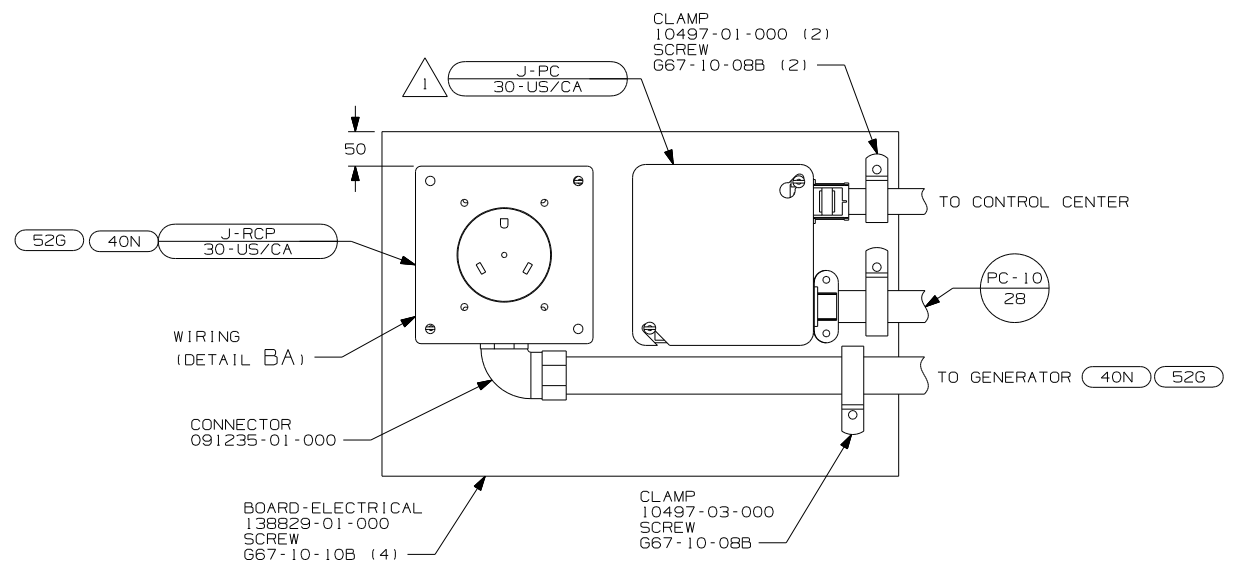

DETAIL BB 2

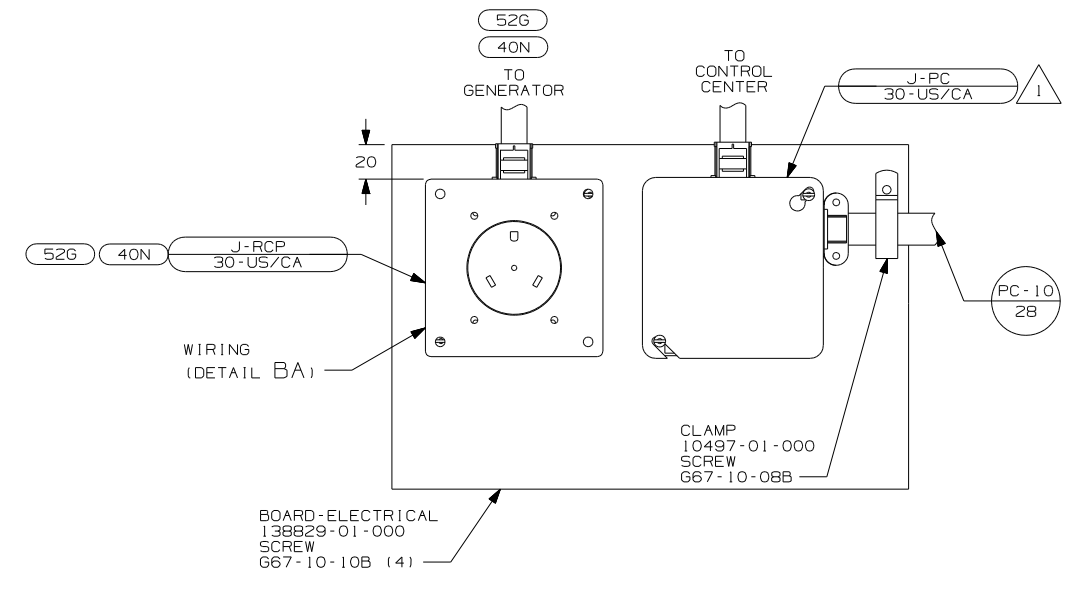

DETAIL BC 3

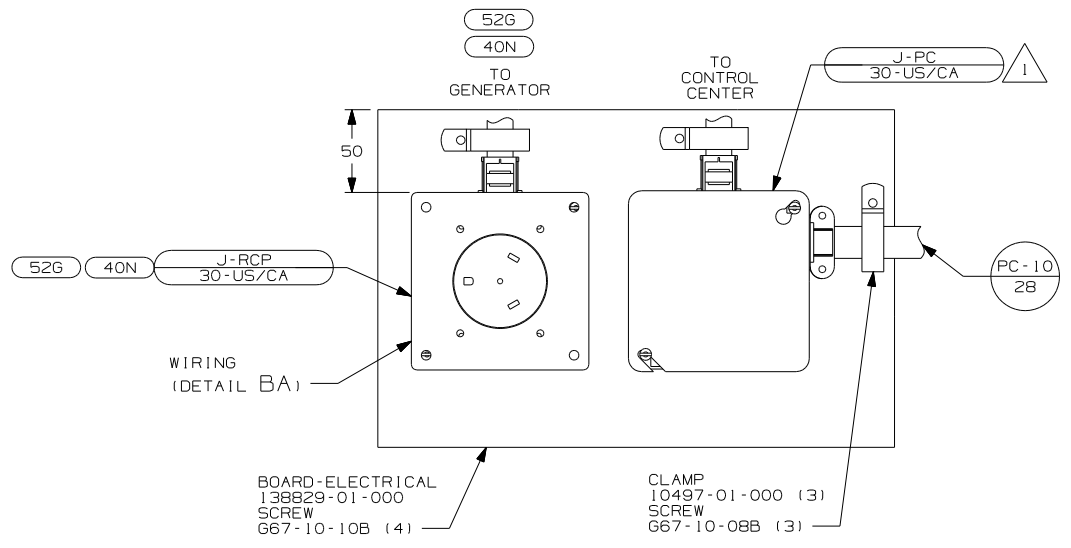

DETAIL BF 5

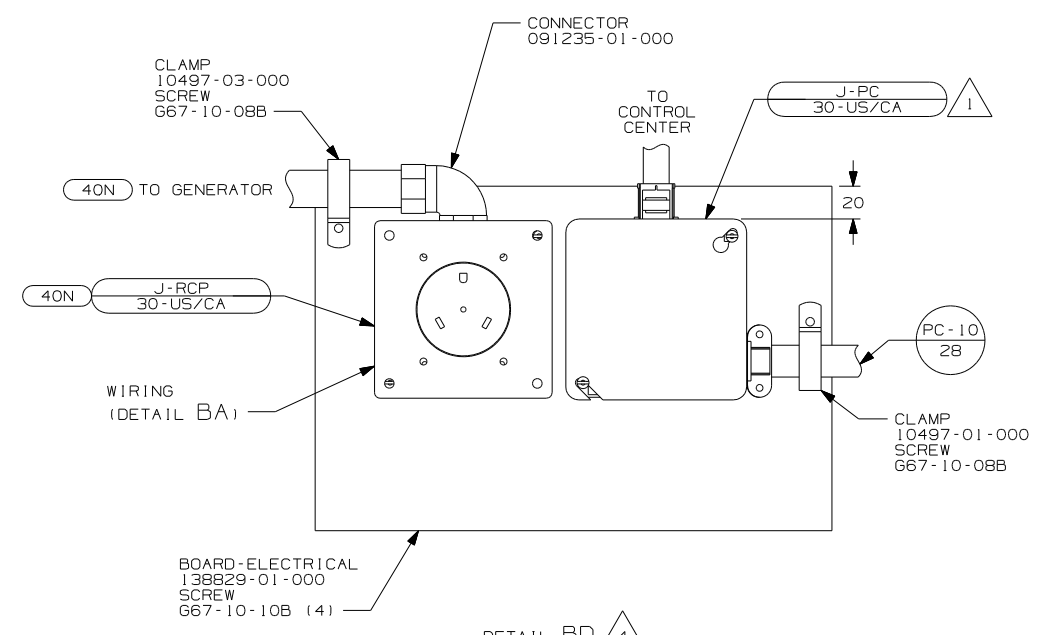

DETAIL BD 4

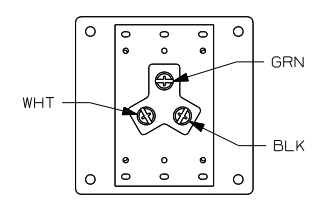

DETAIL BA (BACK VIEW)

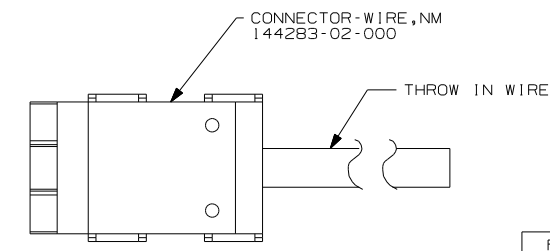

DETAIL BE

- NOTES:
- 5 USED WITH 723D, 726A, 729H.
 - 4 USED WITH 329B, 329K.
 - 3 USED WITH 322R, 322E, 324V, 332G.
 - 2 USED WITH 325F, 326A, 331C, 331T, 327L.
 - 1 CONNECT BLK TO BLK, WHT TO WHT, AND GRNDS TO GRNDS.

FOR ELECTRICAL TORQUE SPECIFICATIONS SEE DWG NO. 128783-01-000

FOR ELECTRICAL CALLOUTS SEE DWG NO. 121339-01-000

- 52G GEN-3.6KW ONAN LP MICROQUIET
- 40N GEN-4.0KW-ONAN-GAS-MICROLITE
- 265 CODES/STANDARDS-CSA/CMVSS
- 1B1 CODES/STANDARDS USA

FIRST USED	
06 300/700-SER	
DO NOT SCALE DRAWING	
TITLE: LOAD CENTER/ATS ASM	
SHEET 2	PART NO 153075