



**DANGER**

**Danger of electrical shock, burns or death.** Always remove all power sources before attempting any repair, service or diagnostic work. Power can be present from shore power, generator, inverter or battery. All power sources must be disabled and secured before performing any service.



**CAUTION**

If you lack the skills, tools or equipment to perform diagnostic or repair work leave such work to an authorized Winnebago Industries dealer or other qualified shop.

CONNECTS TO RADIO SWITCH

CONNECTS TO DASH RADIO ASM

CONNECTS TO WIRE ASM-RIGHT (SHT 3, D-5) (LOCATED BELOW REFRIGERATOR)

CONNECTS TO FORD WIRING (LOCATED BEHIND DRIVER DOOR)

CONNECTS TO WIRE ASM-LEFT (SHT 2, A-2) (LOCATED BELOW BATH VANITY)

CONNECTS TO GENERATOR

CONNECTS TO FORD WIRING (LOCATED NEAR FORD FUSE PANEL)

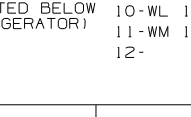
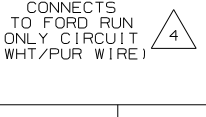
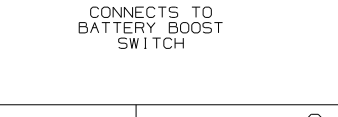
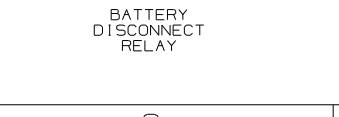
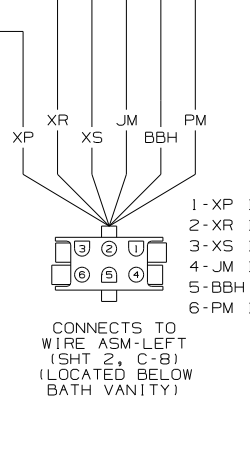
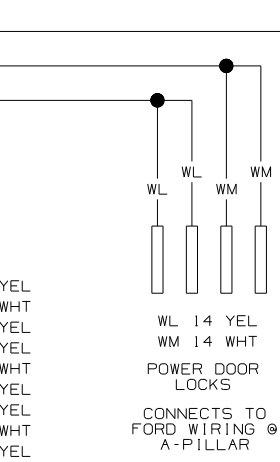
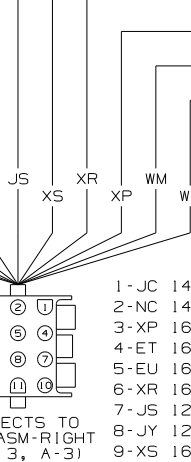
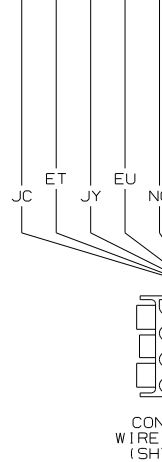
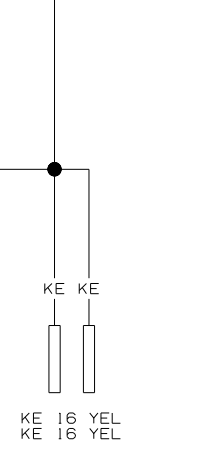
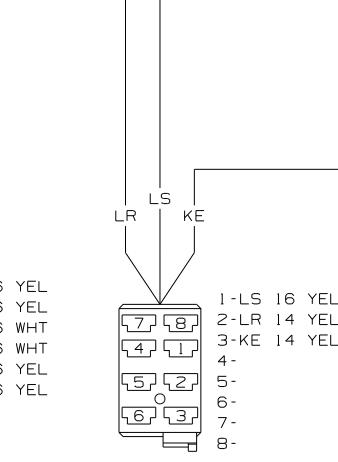
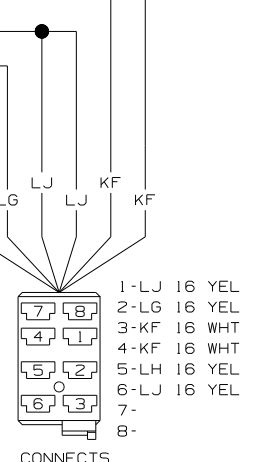
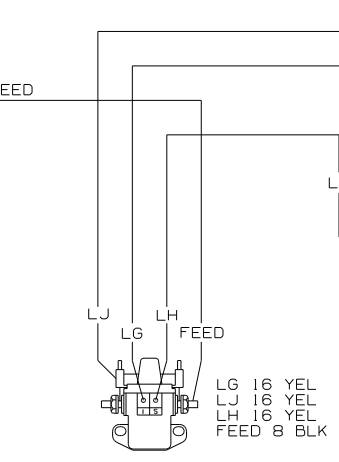
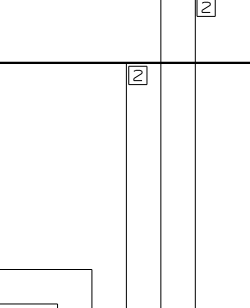
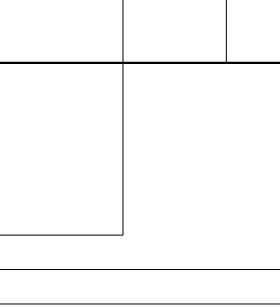
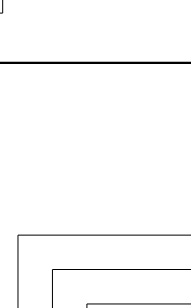
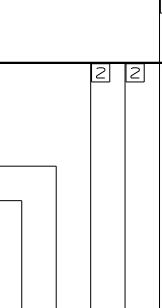
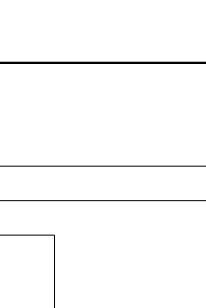
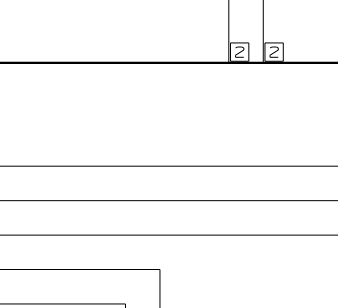
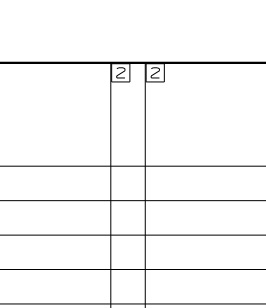
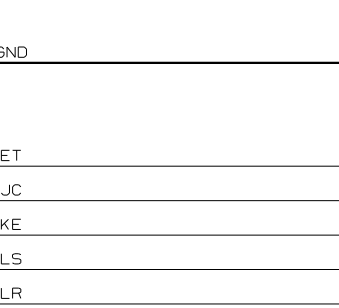
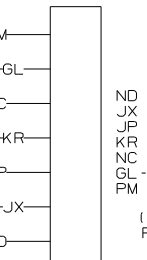
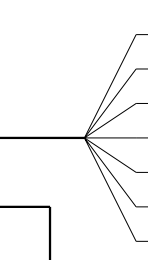
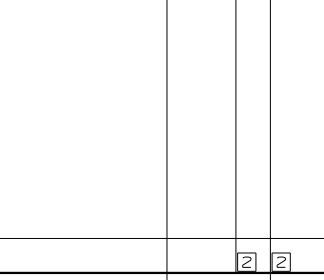
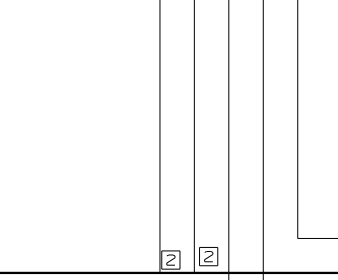
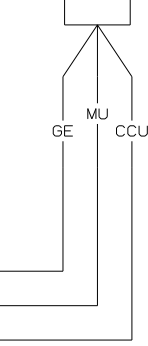
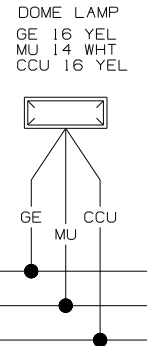
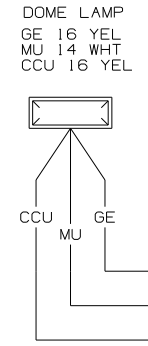
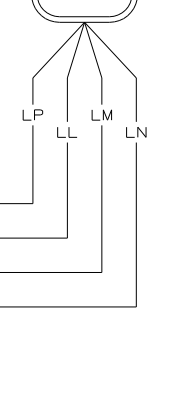
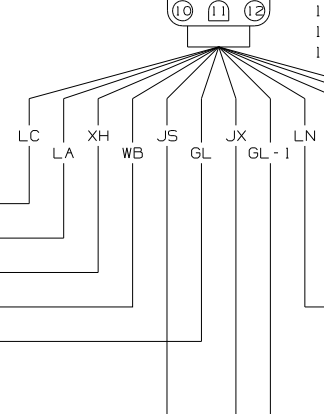
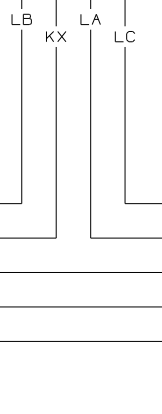
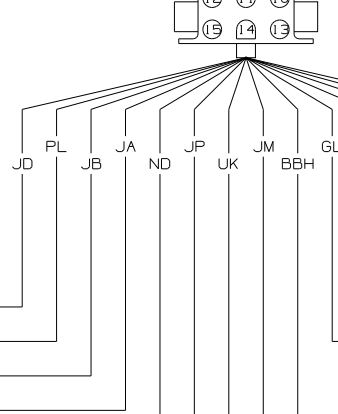
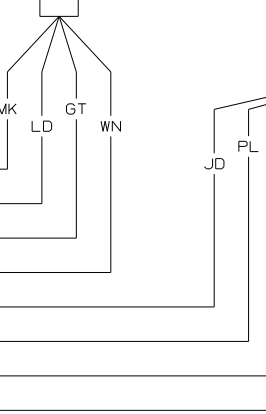
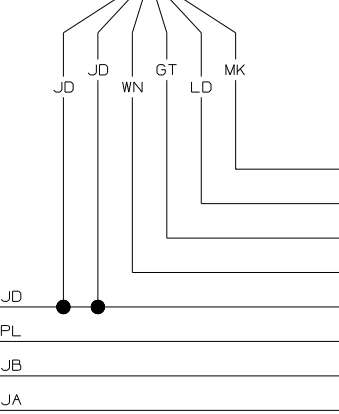
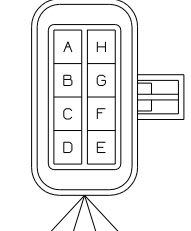
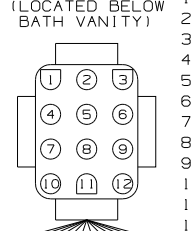
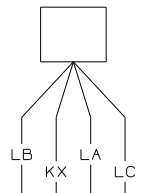
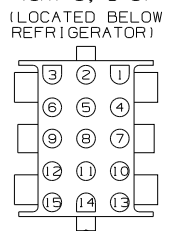
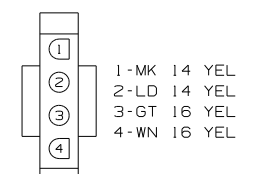
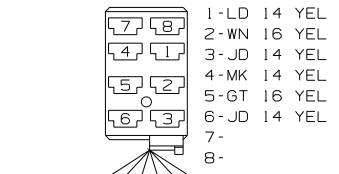

**WINNEBAGO** COPYRIGHT 2004 WINNEBAGO INDUSTRIES, INC.

DFTR	ORIG. DATE
CHNR	ALL DIMENSIONS ARE IN MILLIMETERS
P.E.	FIRST USED
M.E.	06 322R
DSNR	

UNSPECIFIED TOLERANCES ARE: MATERIAL:

WHOLE DIM (XX) :  
 ONE-PLACE (X.X) :  
 TWO-PLACE (X.XX) :  
 ANGLE :  
 THIRD ANGLE PROJECTION

**DO NOT SCALE DRAWING**

TITLE: WIRING DIAGRAM-BODY, 12V

SHEET 1 of 5 PART NO 152271

REF: 1 5/17/2005

WIRING DIAGRAM-CHASSIS, FORD (WIRE ASM 150421 REV-D)

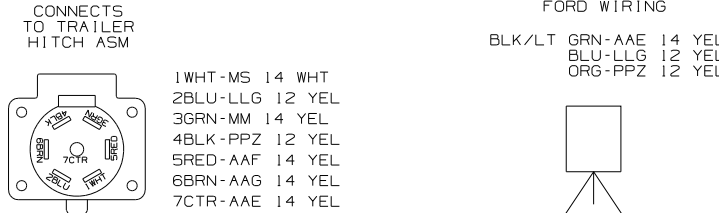

CONNECTS TO FORD WIRING  
 BLK/LT GRN-AAE 14 YEL  
 BLU-LLG 12 YEL  
 ORG-PPZ 12 YEL

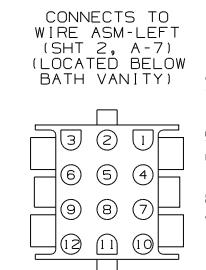
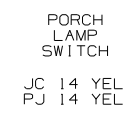
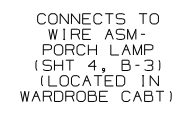

- 1-JA 14 YEL
- 2-JP 16 WHT
- 3-PL 14 YEL
- 4-XX 14 YEL
- 5-JT 16 YEL
- 6-ET 16 YEL
- 7-ND 14 WHT
- 8-KR 16 WHT
- 9-JD 14 YEL
- 10-JC 14 YEL
- 11-NC 14 WHT
- 12-JB 14 YEL

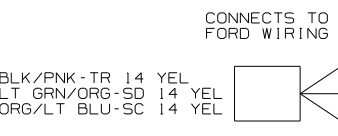
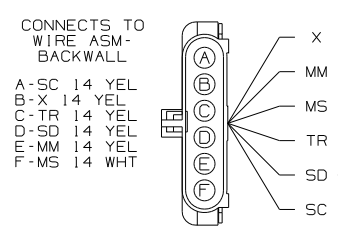
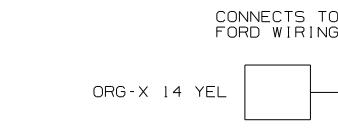
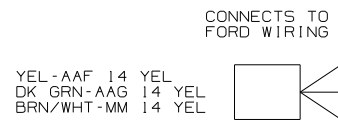

- NOTES:
- 5 SEE WIRING DIAGRAM-AUTO FOR ADDITIONAL INFORMATION.
  - 4 SEE MANUFACTURERS DIAGRAM FOR ADDITIONAL INFORMATION.
  - 3 GROUNDS ARE SHOWN AS A SINGLE LINE FOR EASE IN TRACING. EACH GROUND CIRCUIT IS SEPERATE IN THE HARNESS.
  - 2 NOT A SPLICE POINT. INDICATES ENTRY INTO WIRING HARNESS.
  1. SPLICES ARE THEORETICAL AND MAY DIFFER IN THE HARNESS.

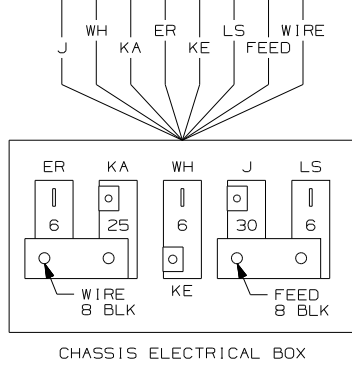
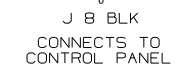
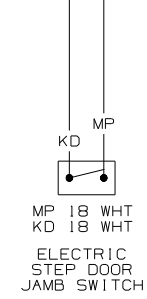
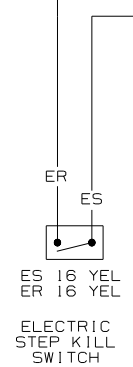
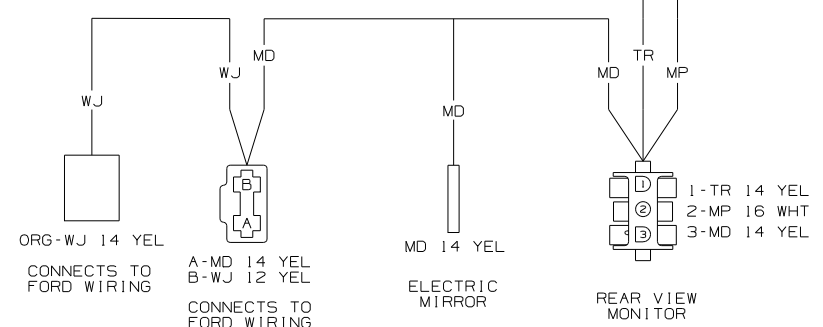

- J 8 BLK
- ER 16 YEL
- KA 12 YEL
- WH 16 YEL
- LS 16 YEL
- KE 14 YEL
- WIRE 8 BLK
- FEED 8 BLK

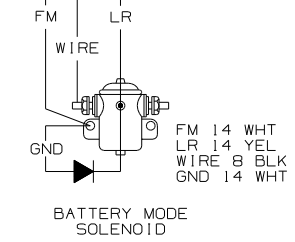

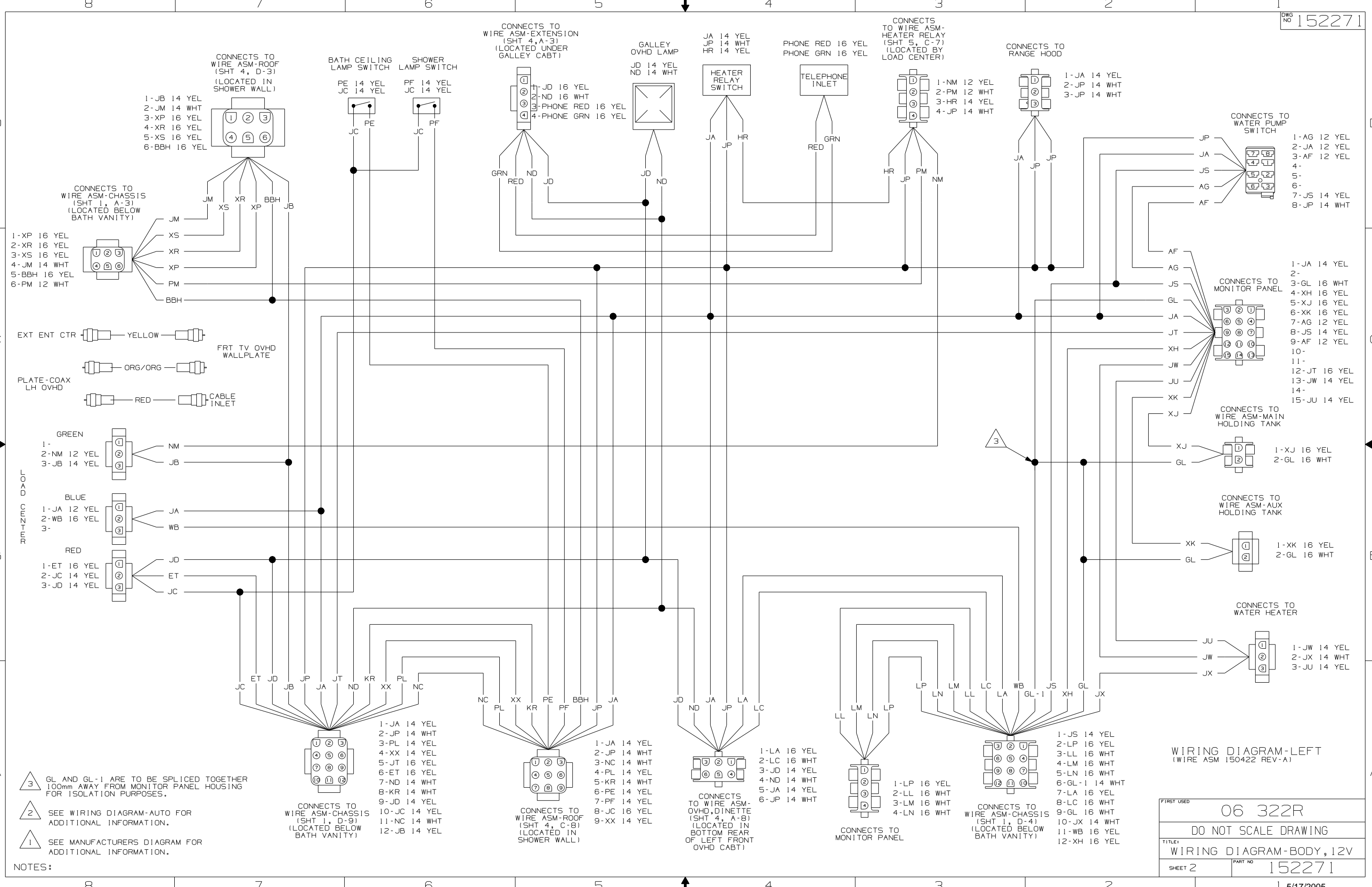

- CONNECTS TO WIRE ASM-CHASSIS (SHT 1, A-3) (LOCATED BELOW BATH VANITY)
- 1-XP 16 YEL
  - 2-XR 16 YEL
  - 3-XS 16 YEL
  - 4-JM 14 WHT
  - 5-BBH 16 YEL
  - 6-PM 12 WHT

- EXT ENT CTR YELLOW
- PLATE-COAX LH OVHD ORG/ORG
- RED CABLE INLET

- GREEN
- 1-NM 12 YEL
  - 3-JB 14 YEL
- BLUE
- 1-JA 12 YEL
  - 2-WB 16 YEL
  - 3-
- RED
- 1-ET 16 YEL
  - 2-JC 14 YEL
  - 3-JD 14 YEL

- NOTES:
- 3 GL AND GL-1 ARE TO BE SPLICED TOGETHER 100mm AWAY FROM MONITOR PANEL HOUSING FOR ISOLATION PURPOSES.
  - 2 SEE WIRING DIAGRAM-AUTO FOR ADDITIONAL INFORMATION.
  - 1 SEE MANUFACTURERS DIAGRAM FOR ADDITIONAL INFORMATION.

WIRING DIAGRAM-LEFT (WIRE ASM 150422 REV-A)

FIRST USED	06 322R
DO NOT SCALE DRAWING	
TITLE: WIRING DIAGRAM-BODY, 12V	
SHEET 2	PART NO 152271

1 5/17/2005

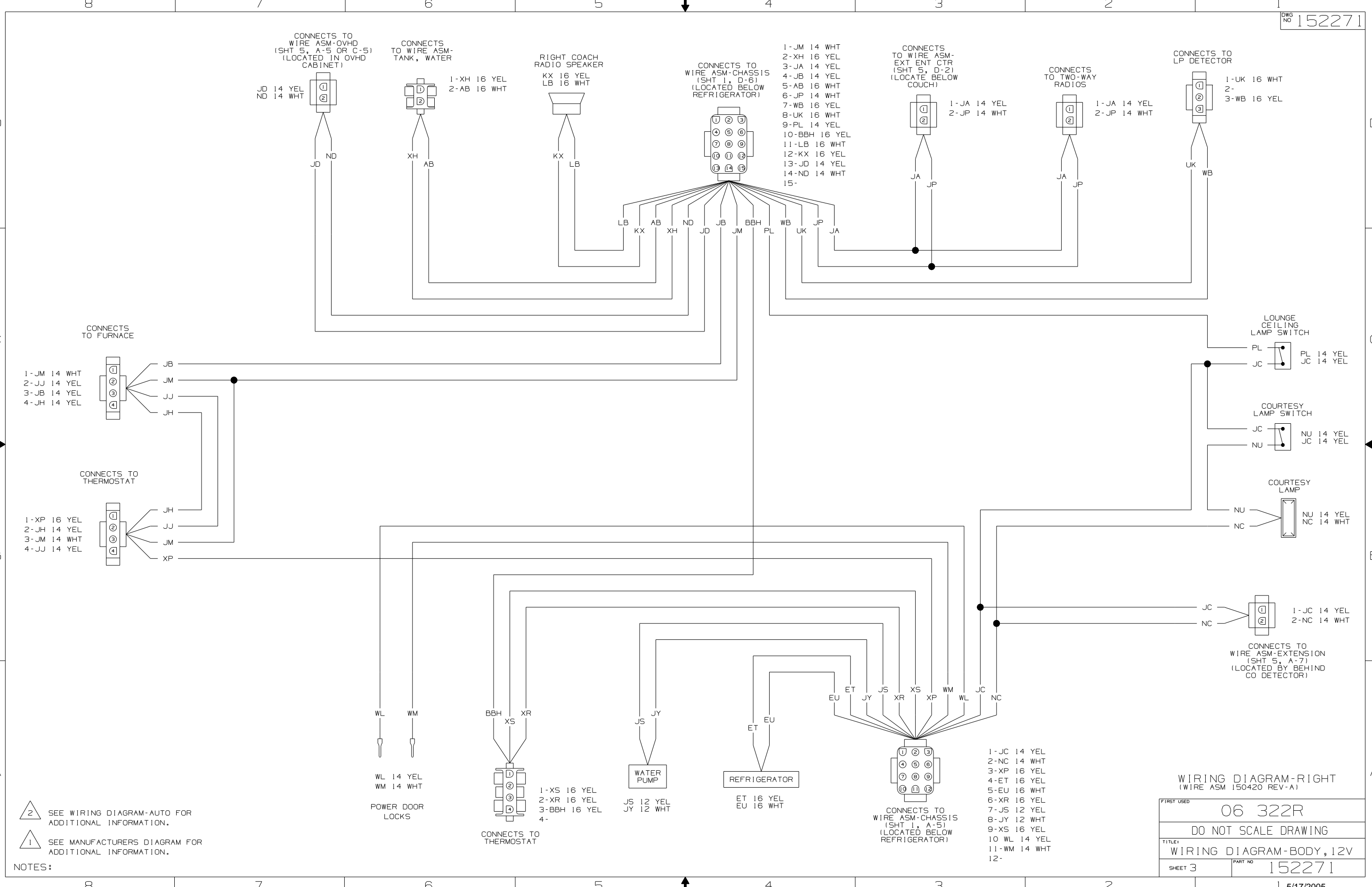

2 SEE WIRING DIAGRAM-AUTO FOR ADDITIONAL INFORMATION.

1 SEE MANUFACTURERS DIAGRAM FOR ADDITIONAL INFORMATION.

NOTES:

WIRING DIAGRAM-RIGHT  
(WIRE ASM 150420 REV-A)

FIRST USED	06 322R
DO NOT SCALE DRAWING	
TITLE:	WIRING DIAGRAM-BODY, 12V
SHEET 3	PART NO 152271

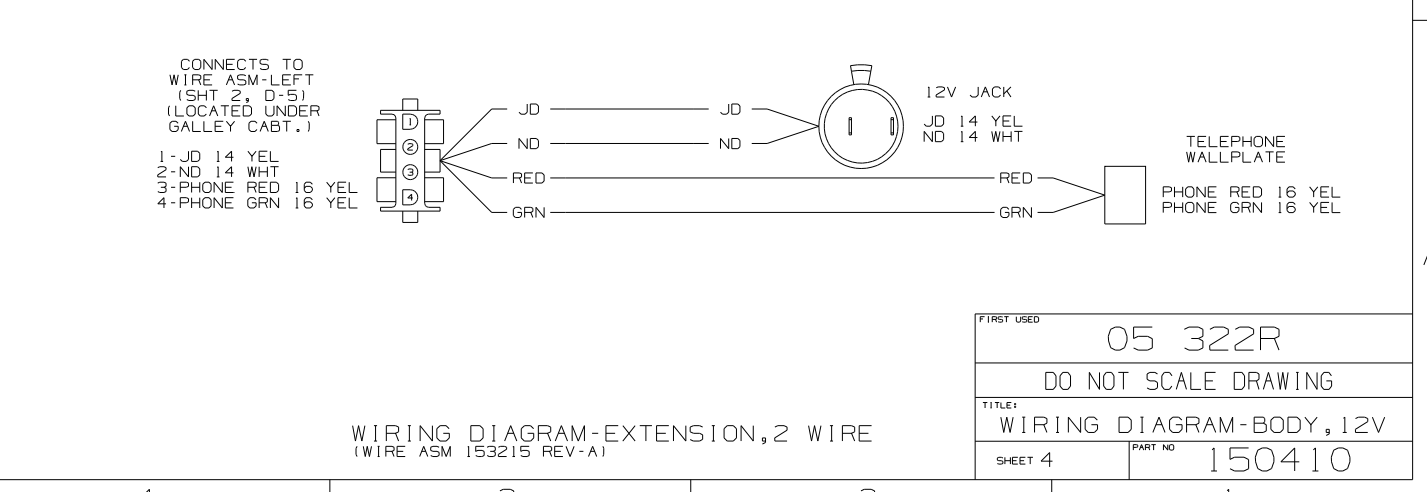
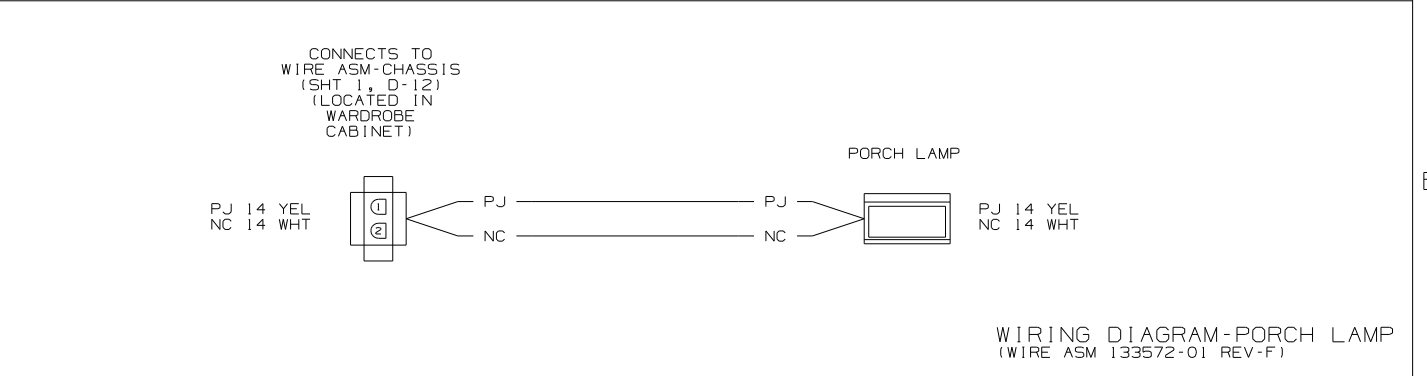
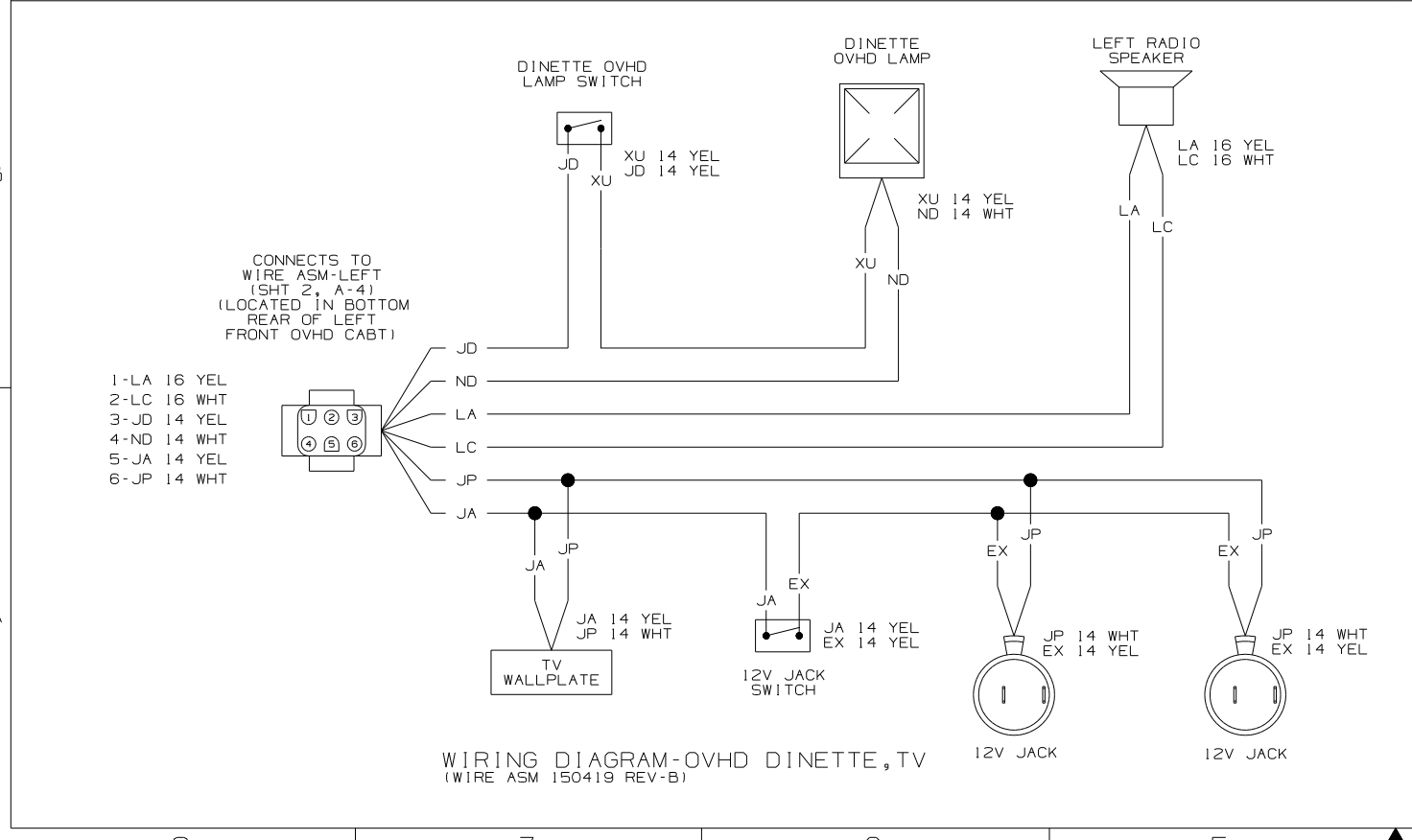
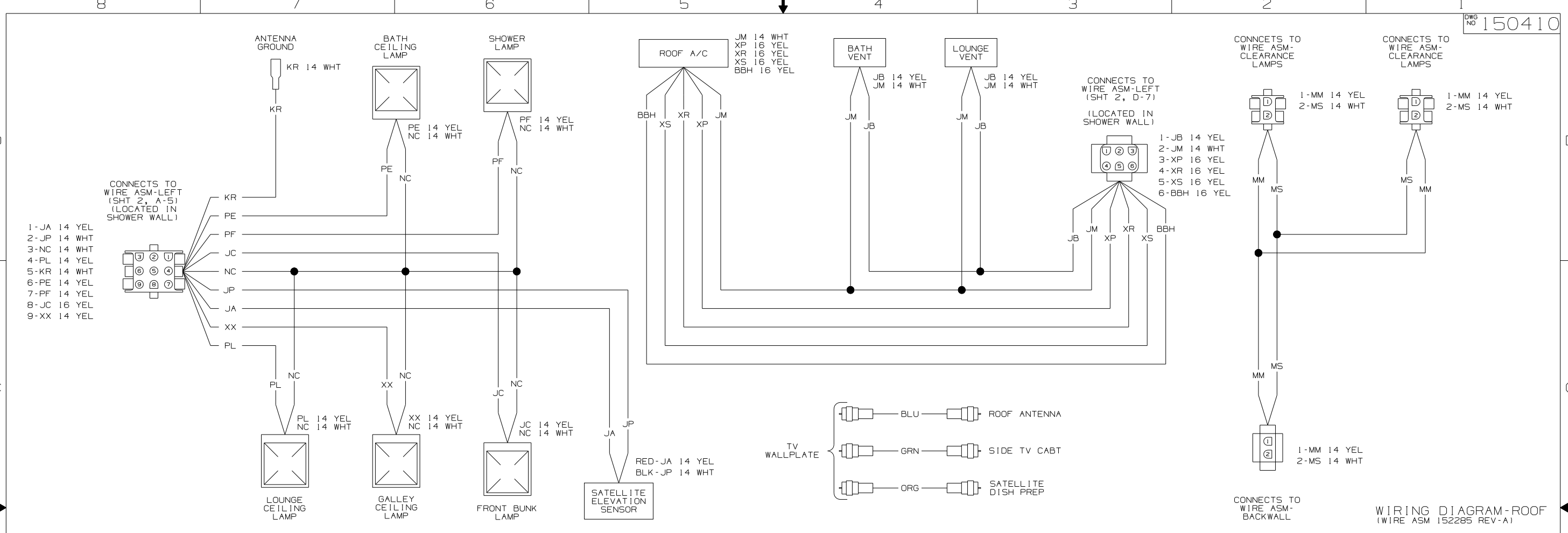

FIRST USED	05 322R
TITLE	DO NOT SCALE DRAWING
TITLE	WIRING DIAGRAM-BODY, 12V
SHEET 4	PART NO 150410

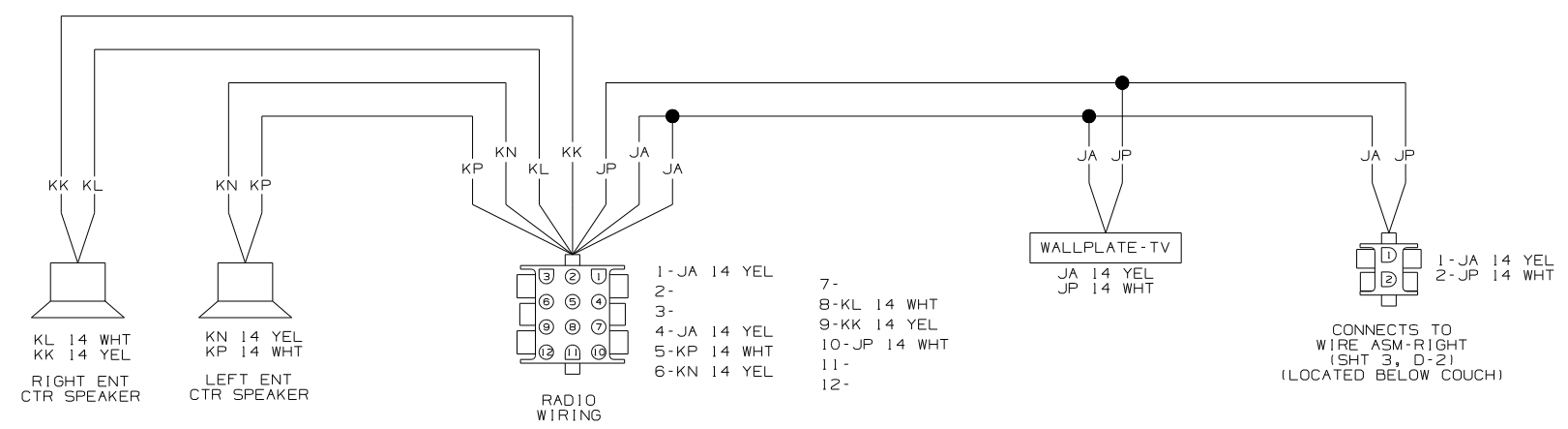

WIRING DIAGRAM-ENTERTAINMENT CENTER  
(WIRE ASM 125853-04 REV-L)

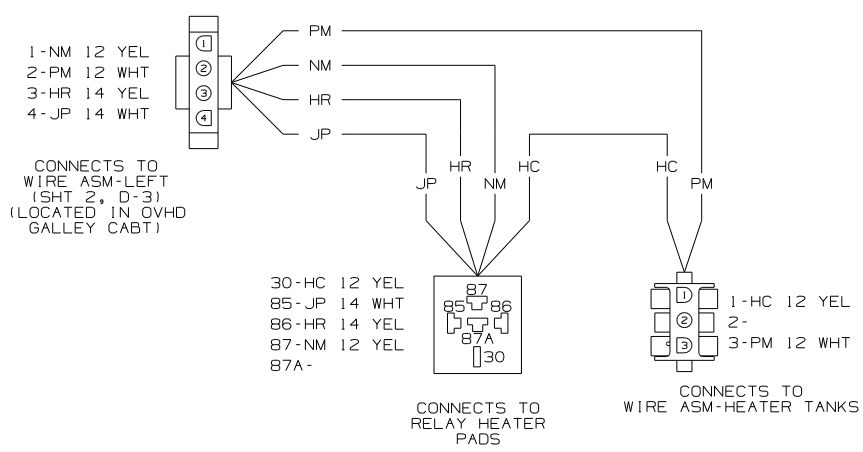

WIRING DIAGRAM-HEATER, RELAY  
(WIRE ASM 153891 REV-A)

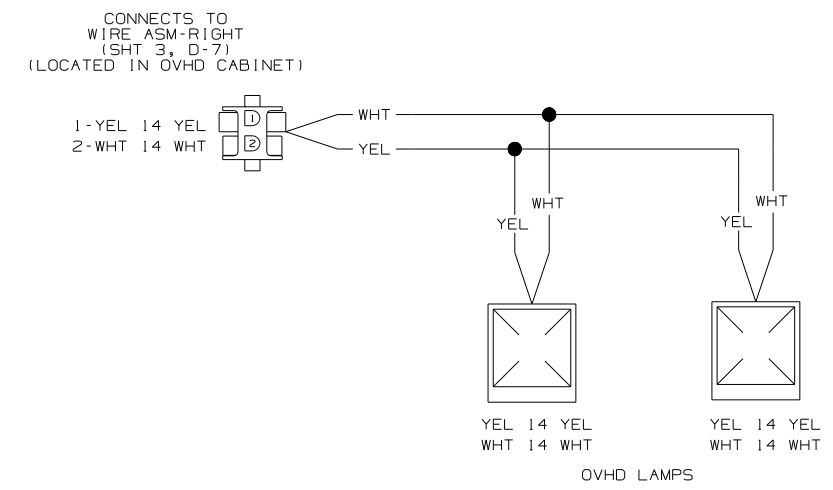

WIRING DIAGRAM-OVHD  
(WIRE ASM 153235 REV-B)

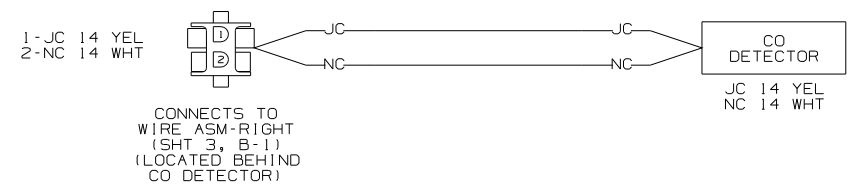

WIRING DIAGRAM-EXTENSION  
(WIRE ASM 149130 REV-B)

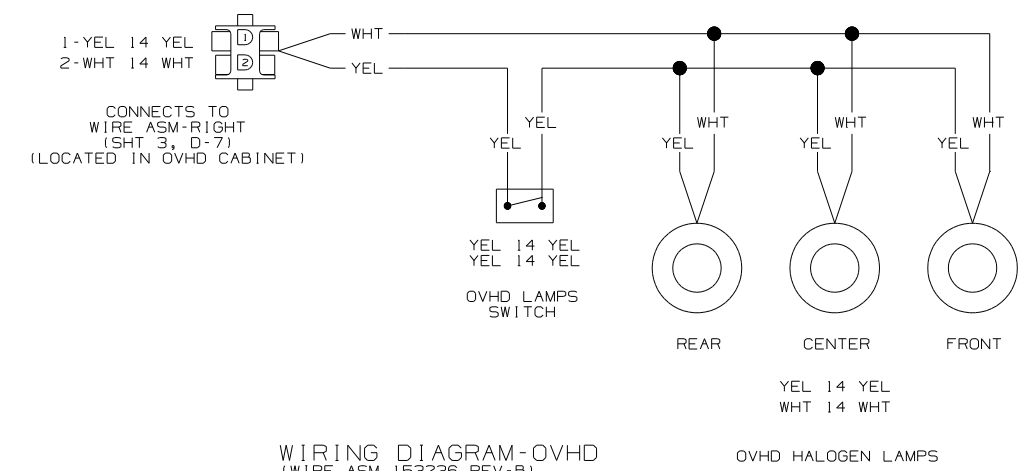

WIRING DIAGRAM-OVHD  
(WIRE ASM 153236 REV-B)

FIRST USED	05 322R
TITLE	DO NOT SCALE DRAWING
TITLE	WIRING DIAGRAM-BODY, 12V
SHEET 5	PART NO 150410