



DANGER

Danger of electrical shock, burns or death. Always remove all power sources before attempting any repair, service or diagnostic work. Power can be present from shore power, generator, inverter or battery. All power sources must be disabled and secured before performing any service.



CAUTION

If you lack the skills, tools or equipment to perform diagnostic or repair work leave such work to an authorized Winnebago Industries dealer or other qualified shop.

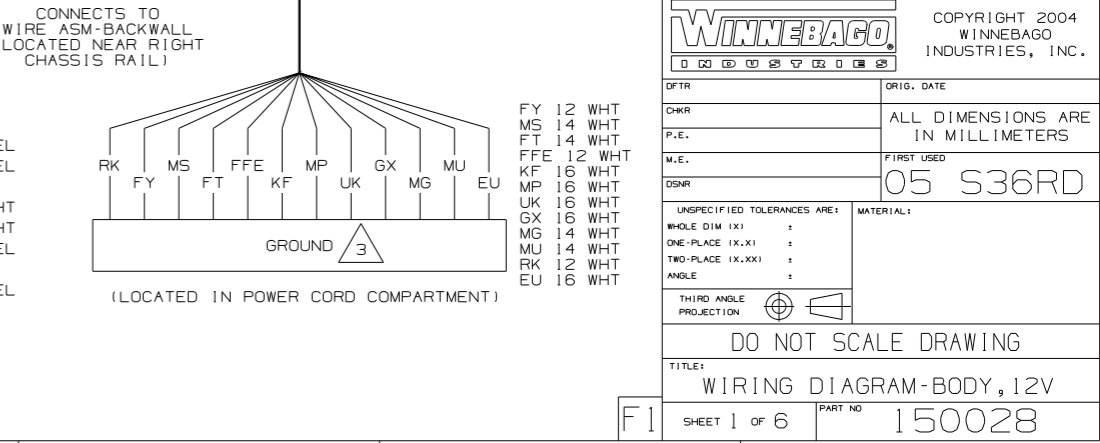
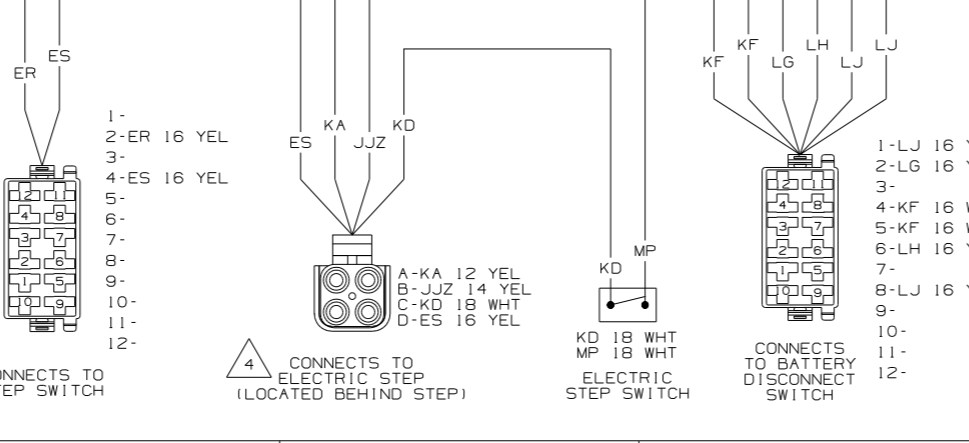
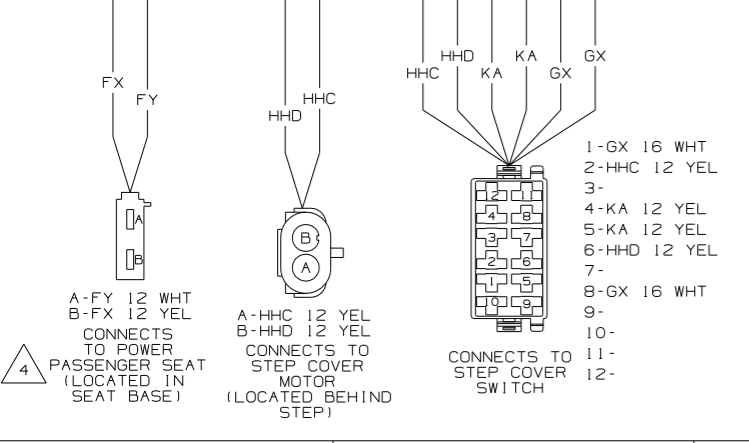
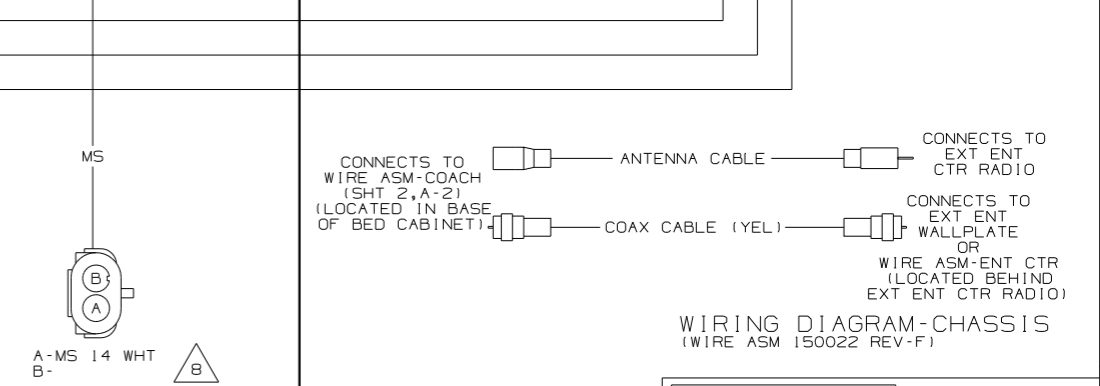
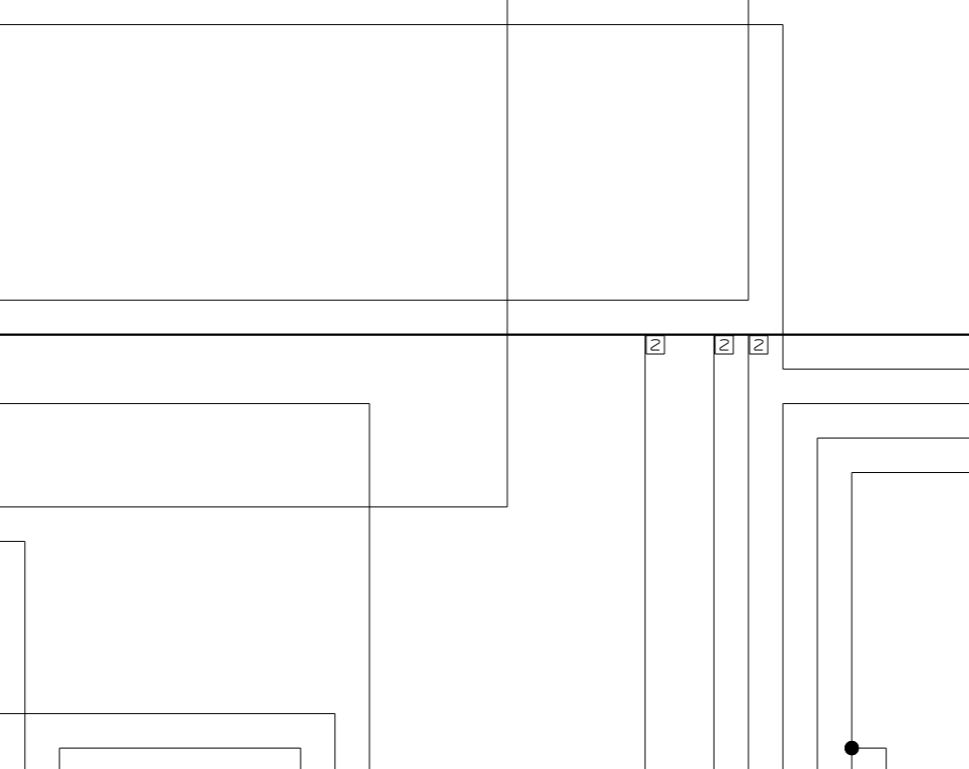
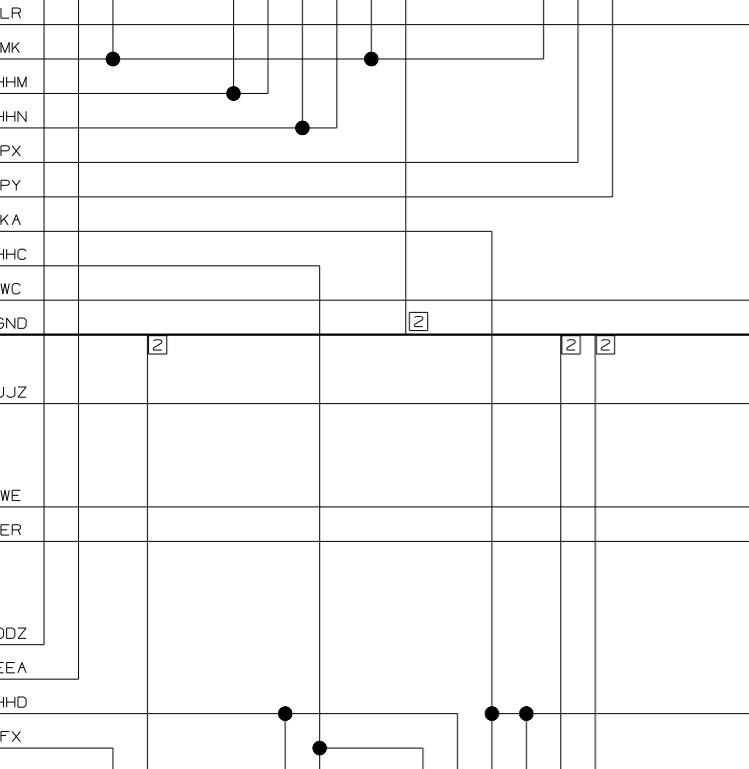
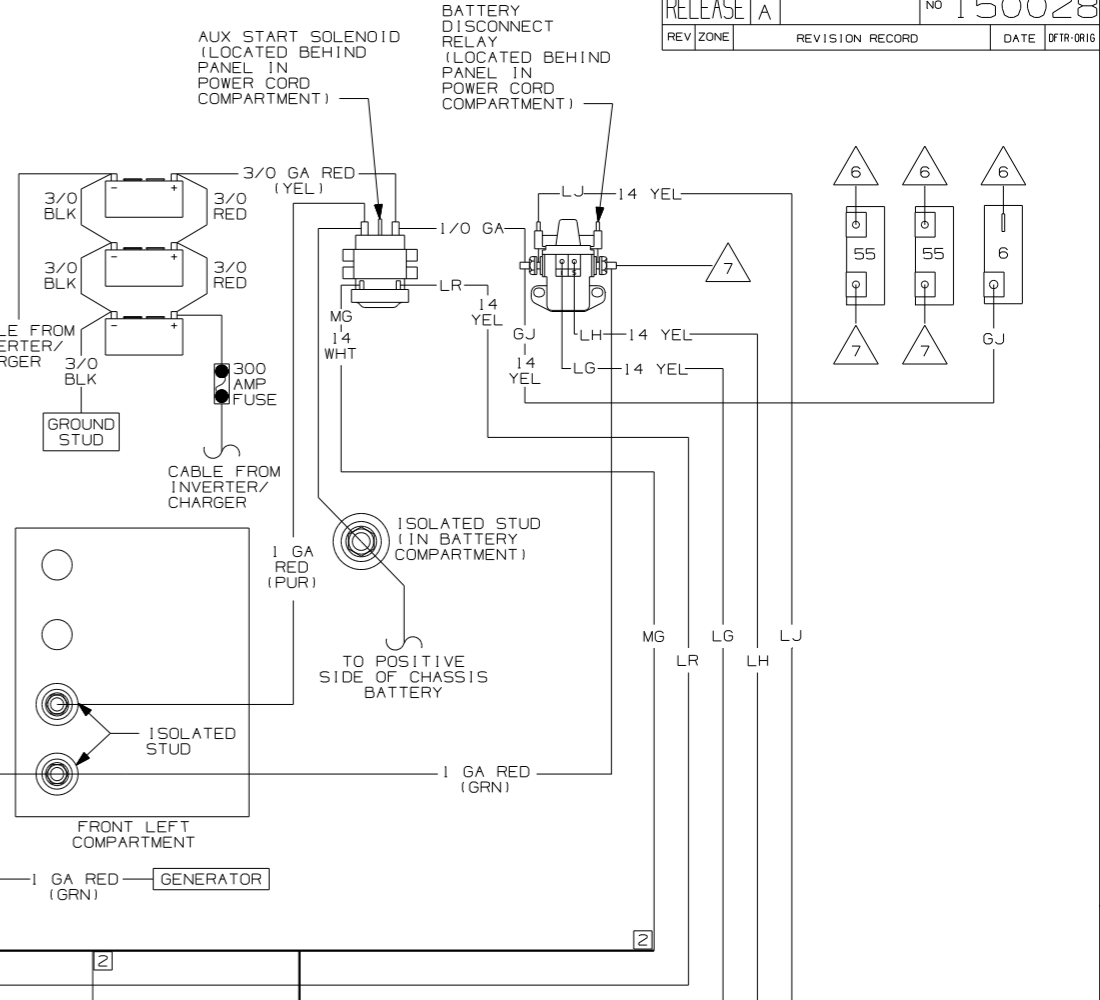
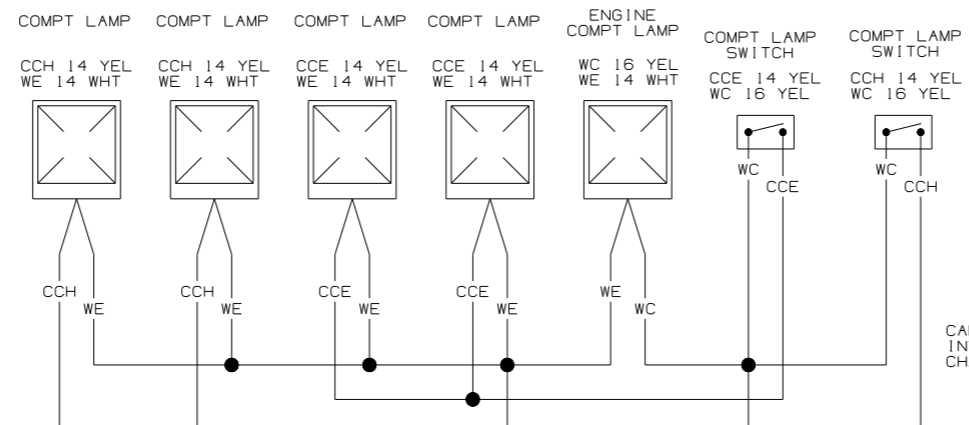
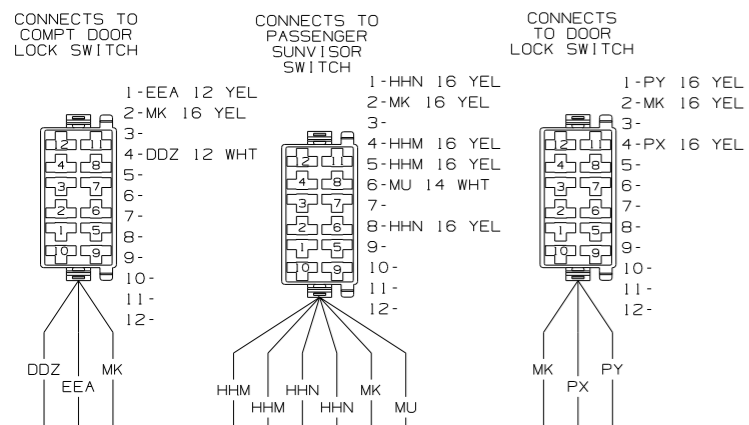

CONNECTS TO WIRE ASM-SIDEWALL (SHT 5, D-8) (LOCATED IN PASSENGERS CONSOLE)

- 1-PJ 14 YEL
- 2-PM 14 WHT
- 3-FFF 12 YEL
- 4-FFG 12 WHT
- 5-FFH 12 YEL
- 6-FFJ 12 WHT
- 7-
- 8-HA 14 YEL
- 9-

- A1-AAX 16 WHT
- A2-HHC 12 YEL
- A3-FS 14 YEL
- B1-BBM 16 YEL
- B2-BBN 16 YEL
- B3-CCY 16 YEL
- B4-KKK 16 YEL
- C1-DDA 16 YEL
- C2-HHM 16 YEL
- D1-LL 16 WHT

5 CONNECTS TO WIRE ASM-IP MAIN (LOCATED ON FRONT LEFT COMPT)

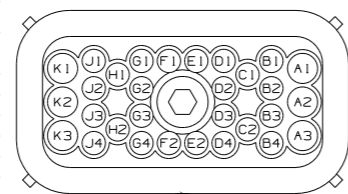

- D2-LM 16 WHT
- D3-LN 16 WHT
- D4-HU 16 YEL
- E1-MM 14 YEL
- E2-WC 16 YEL
- F1-MK 16 YEL
- F2-LR 14 YEL
- G1-DL 16 YEL
- G2-DM 16 WHT
- G3-DJ 16 YEL
- G4-DK 16 WHT
- H1-HHN 16 YEL
- H2-PX 16 YEL
- J1-PJ 16 YEL
- J2-JJZ 14 YEL
- J3-ER 16 YEL
- J4-PY 16 YEL
- K1-FFD 12 YEL
- K2-KA 12 YEL
- K3-AAW 16 YEL

CONNECTS TO LEFT REAR SLIDEOUT SWITCH



- 1-DDA 16 YEL
- 2-CCY 16 YEL
- 3-DDA 16 YEL
- 4-BBM 16 YEL
- 5-KKK 16 YEL
- 6-BBN 16 YEL
- 7-
- 8-

CONNECTS TO RIGHT REAR SLIDEOUT SWITCH



- 1-DDA 16 YEL
- 2-CCY 16 YEL
- 3-DDA 16 YEL
- 4-HHE 16 YEL
- 5-KKL 16 YEL
- 6-HHF 16 YEL
- 7-
- 8-

CONNECTS TO PASSENGER HEATER CONTROLS

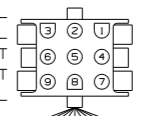

- 1-MMS 12 YEL
- 2-MMT 12 YEL
- 3-MMU 12 YEL
- 4-MMV 12 YEL
- 5-MMW 16 YEL
- 6-MMX 16 WHT
- 7-MMY 16 WHT
- 8-NNL 16 YEL
- 9-NNM 16 YEL

CONNECTS TO ENTRANCE DOOR PAD



- 1-MK 14 YEL
- 2-MU 14 WHT
- 3-NNK 16 YEL
- 4-

LEFT SIDE DOCKING LAMP

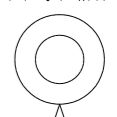

RIGHT SIDE DOCKING LAMP

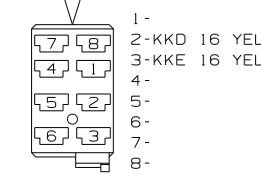
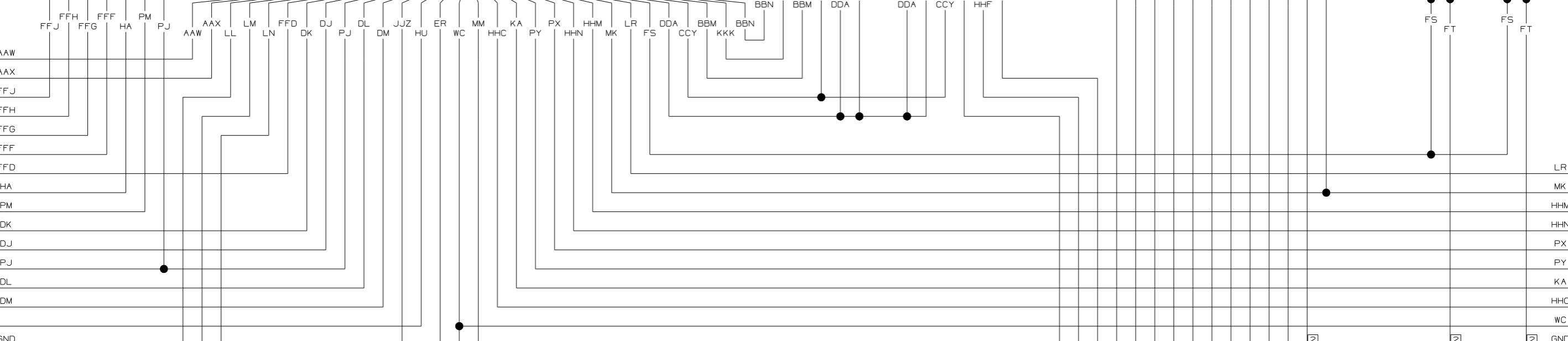
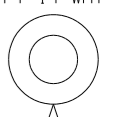

CONNECTS TO LP VALVE SWITCH

- 1-KKD 16 YEL
- 2-LL 16 WHT
- 3-LM 16 WHT
- 4-LN 16 WHT
- 5-LP 16 YEL
- 6-JE 14 YEL
- 7-ER 16 YEL
- 8-JT 16 YEL
- 9-WC 16 YEL
- 10-WE 14 WHT
- 11-DDT 12 YEL
- 12-DDU 12 WHT
- 13-DDV 12 YEL
- 14-DDW 12 WHT
- 15-JJT 14 YEL

CONNECTS TO WIRE ASM-COACH (SHT 2, A-17) (LOCATED IN BED BASE)



CONNECTS TO WIRE ASM-LOCK, COMPT DOORS (RIGHT SIDE)



CONNECTS TO WIRE ASM-LOCK, COMPT DOORS (RIGHT SIDE)

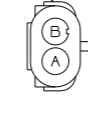

CONNECTS TO WIRE ASM-LOCK, COMPT DOORS (RIGHT SIDE)

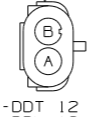

CONNECTS TO WIRE ASM-LOCK, COMPT DOORS (RIGHT SIDE)



CONNECTS TO WIRE ASM-LOCK, COMPT DOORS (LEFT SIDE)



CONNECTS TO WIRE ASM-LOCK, COMPT DOORS (LEFT SIDE)



CONNECTS TO WIRE ASM-LOCK, COMPT DOORS (LEFT SIDE)



CONNECTS TO COOLING FAN

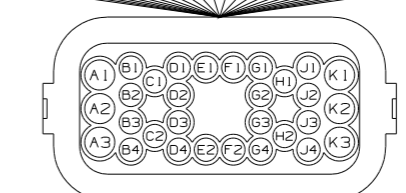

5 CONNECTS TO WIRE ASM-IP MAIN (LOCATED ON FRONT LEFT COMPT)

- A1-DDT 12 YEL
- A2-DDU 12 WHT
- A3-DDV 12 YEL
- B1-
- B2-
- B3-
- B4-RE 12 YEL
- C1-DDZ 12 YEL
- C2-EEA 12 WHT
- D1-MMS 12 YEL
- D2-MMT 12 YEL
- D3-MMU 12 YEL
- D4-MMN 12 YEL
- E1-NNK 16 YEL
- E2-KKL 16 YEL
- F1-HHE 16 YEL
- F2-HHF 16 YEL
- G1-MMW 16 YEL
- G2-MMX 16 WHT
- G3-MMY 16 WHT
- G4-NNL 16 YEL
- H1-LP 16 YEL
- H2-NNM 16 YEL
- J1-
- J2-
- J3-
- J4-KKN 16 YEL
- K1-DDW 12 WHT
- K2-HHD 12 YEL
- K3-FX 12 YEL

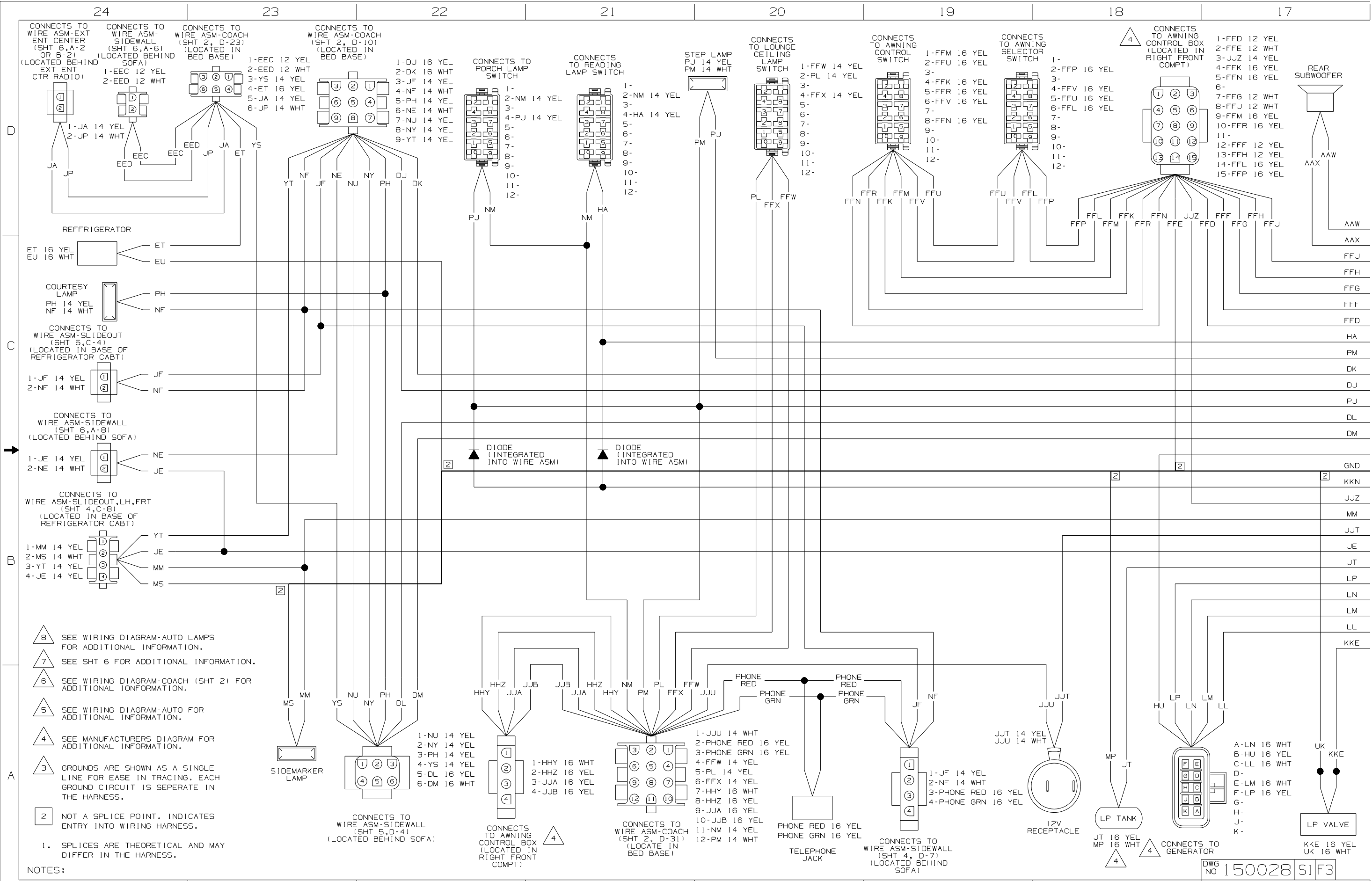

NOTES:
 1. SPLICES ARE THEORETICAL AND MAY DIFFER IN THE HARNESS.

- 8 SEE WIRING DIAGRAM-AUTO LAMPS FOR ADDITIONAL INFORMATION.
- 7 SEE SHT 6 FOR ADDITIONAL INFORMATION.
- 6 SEE WIRING DIAGRAM-COACH (SHT 2) FOR ADDITIONAL INFORMATION.
- 5 SEE WIRING DIAGRAM-AUTO FOR ADDITIONAL INFORMATION.
- 4 SEE MANUFACTURERS DIAGRAM FOR ADDITIONAL INFORMATION.
- 3 GROUNDS ARE SHOWN AS A SINGLE LINE FOR EASE IN TRACING. EACH GROUND CIRCUIT IS SEPERATE IN THE HARNESS.
- 2 NOT A SPLICE POINT. INDICATES ENTRY INTO WIRING HARNESS.

WATER HEATER SWITCH

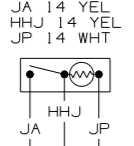

JA 14 YEL
HHJ 14 YEL
JP 14 WHT

WATER HEATER

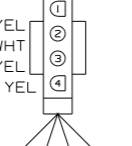

1-JW 14 YEL
2-JX 14 WHT
3-JU 14 YEL
4-HHJ 14 YEL

EXTERIOR MONITOR PANEL

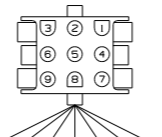

1-BBY 14 YEL
2-CCR 14 YEL
3-JA 14 YEL
4-CCD 16 YEL
5-CCC 16 YEL
6-CCB 16 YEL
7-JP 14 WHT
8-
9-

MONITOR PANEL SWITCH

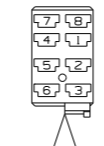

1-BBY 14 YEL
2-CCR 14 YEL
3-
4-
5-
6-
7-
8-

WIRE ASM-WATER TANK (LOCATED IN CENTER LUGGAGE COMPT)

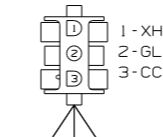

1-XH 16 YEL
2-GL 16 WHT
3-CCB 16 YEL

WIRE ASM-MAIN HOLDING (LOCATED BEHIND WATER CENTER PANEL)

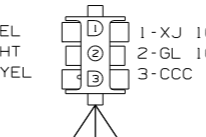

1-XJ 16 YEL
2-GL 16 WHT
3-CCC 16 YEL

WIRE ASM-AUX HOLDING (LOCATED BEHIND WATER CENTER PANEL)

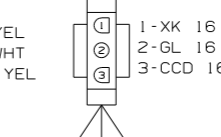

1-XK 16 YEL
2-GL 16 WHT
3-CCD 16 YEL

LOAD SHEDDER CONTROL BOARD (IN 110V PANEL)

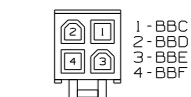

1-BBC 16 Y
2-BBD 16 Y
3-BBE 16 Y
4-BBF 16 Y

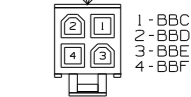
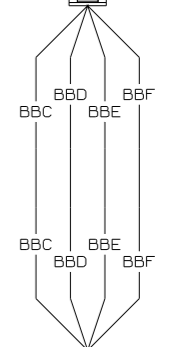

LOAD SHEDDER MONITOR PANEL

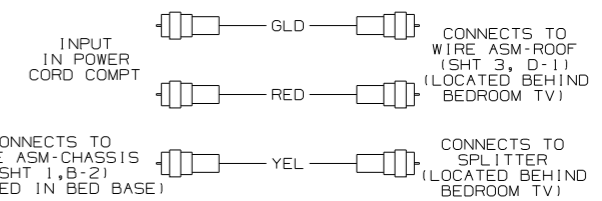
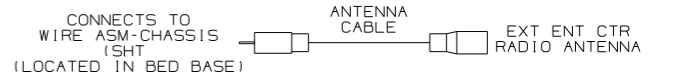

JU
JW
JA

GRND

XH
XJ
XK

WC

WA

CONNECTS TO WIRE ASM-SIDEWALL LEFT (SHT 4, B-8) (LOCATED IN BASE OF WASHER/DRYER CABT)

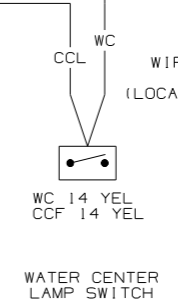
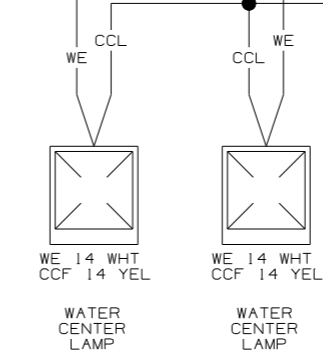
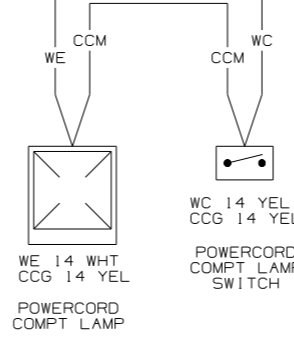
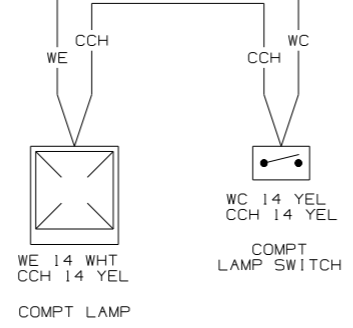

WIRING DIAGRAM-COACH (WIRE ASM 150025 REV-G)

FIRST USED 05 S36RD

DO NOT SCALE DRAWING

TITLE: WIRING DIAGRAM-BODY, 12V

F1 SHEET 2 PART NO 150028

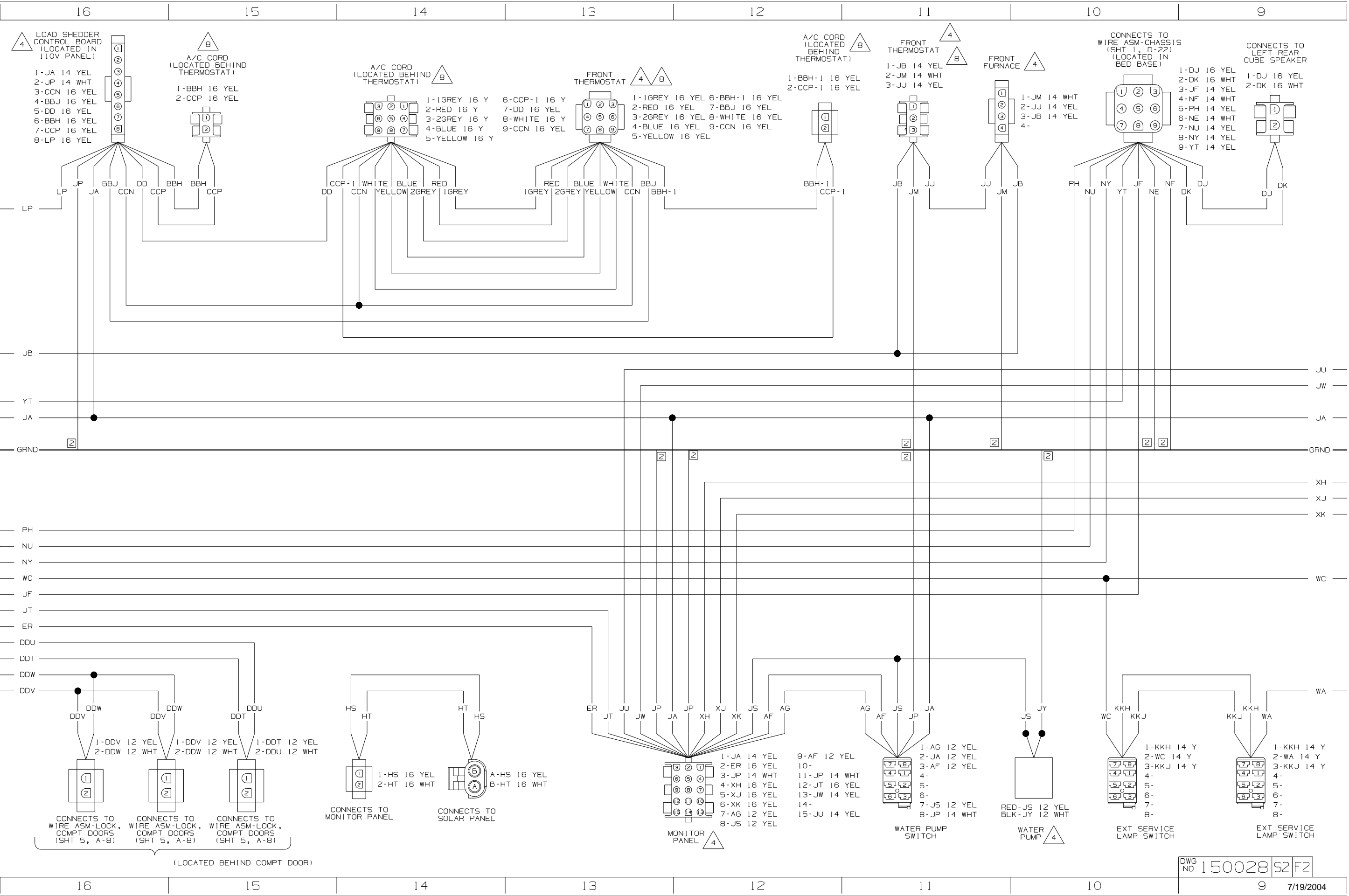

- 4 LOAD SHEDDER CONTROL BOARD (LOCATED IN 110V PANEL)
- 1-JA 14 YEL
 - 2-JP 14 WHT
 - 3-CCN 16 YEL
 - 4-BBJ 16 YEL
 - 5-DD 16 YEL
 - 6-BBH 16 YEL
 - 7-CCP 16 YEL
 - 8-LP 16 YEL

- 8 A/C CORD (LOCATED BEHIND THERMOSTAT)
- 1-BBH 16 YEL
 - 2-CCP 16 YEL

- 8 A/C CORD (LOCATED BEHIND THERMOSTAT)
- 1-1GREY 16 Y
 - 2-RED 16 Y
 - 3-2GREY 16 Y
 - 4-BLUE 16 Y
 - 5-YELLOW 16 Y
 - 6-CCP-1 16 Y
 - 7-DD 16 YEL
 - 8-WHITE 16 Y
 - 9-CCN 16 YEL

- 4 8 FRONT THERMOSTAT
- 1-1GREY 16 YEL
 - 2-RED 16 YEL
 - 3-2GREY 16 YEL
 - 4-BLUE 16 YEL
 - 5-YELLOW 16 YEL
 - 6-BBH-1 16 YEL
 - 7-BBJ 16 YEL
 - 9-CCN 16 YEL

- 8 A/C CORD (LOCATED BEHIND THERMOSTAT)
- 1-BBH-1 16 YEL
 - 2-CCP-1 16 YEL

- 4 8 FRONT THERMOSTAT
- 1-JB 14 YEL
 - 2-JM 14 WHT
 - 3-JJ 14 YEL

- 4 FRONT FURNACE
- 1-JM 14 WHT
 - 2-JJ 14 YEL
 - 3-JB 14 YEL
 - 4-

- CONNECTS TO WIRE ASM-CHASSIS (SHT 1, D-22) (LOCATED IN BED BASE)
- 1-DJ 16 YEL
 - 2-DK 16 WHT
 - 3-JF 14 YEL
 - 4-NF 14 WHT
 - 5-PH 14 YEL
 - 6-NE 14 WHT
 - 7-NU 14 YEL
 - 8-NY 14 YEL
 - 9-YT 14 YEL

- CONNECTS TO LEFT REAR CUBE SPEAKER
- 1-DJ 16 YEL
 - 2-DK 16 WHT

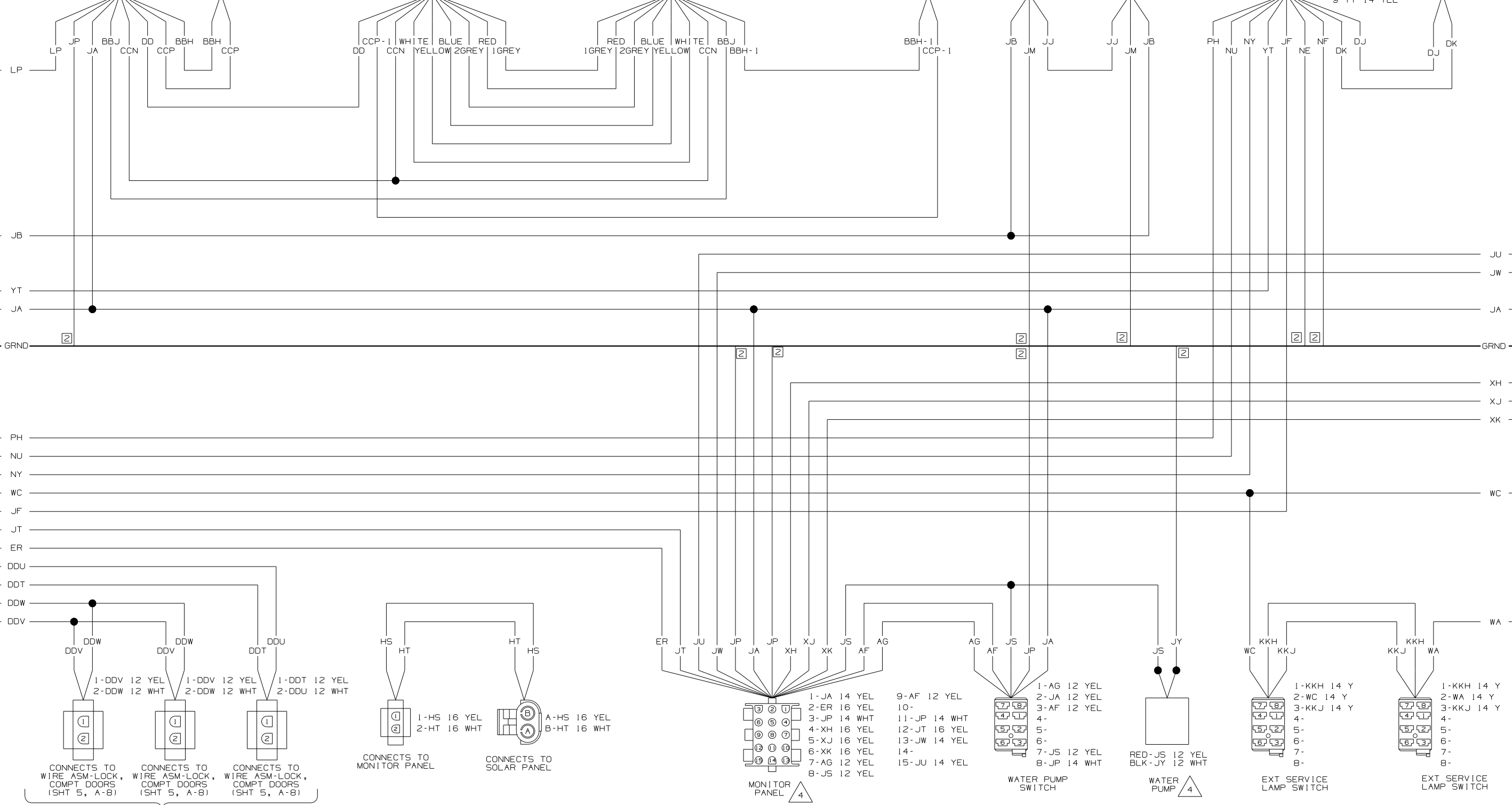

12V BREAKER PANEL

CHASSIS BREAKERS

SOLAR CHARGER INDICATOR LAMP

MONITOR PANEL

POWER CORD REEL

CONNECTS TO WIRE ASM-CHASSIS (SHT 1, A-23) (LOCATED IN BED BASE)

HOSE REEL

CONNECTS TO WIRE ASM-SLIDEOUT, REAR (SHT 4, C-4) (LOCATED BASE OF REAR SLIDEOUT CABT)

- WC 14 YEL
- JA 14 YEL
- JE 14 YEL
- JC 14 YEL
- JD 14 YEL
- JG 14 YEL
- WB 16 YEL
- EEC 14 YEL
- ET 16 YEL
- JJT 14 YEL
- HH 14 YEL
- NM 14 YEL
- JB 14 YEL
- JF 14 YEL

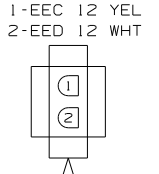
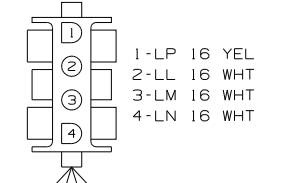
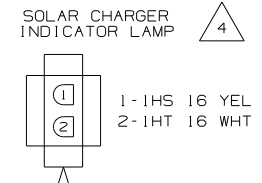
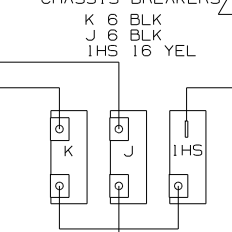
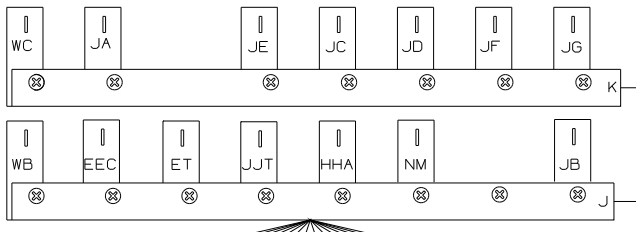

- 1-EEC 12 YEL
- 2-EED 12 WHT
- 3-YS 14 YEL
- 4-ET 16 YEL
- 5-JA 14 YEL
- 6-JP 14 WHT

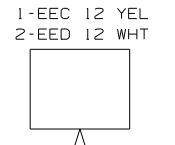

- JG 14 YEL
- ND 14 WHT

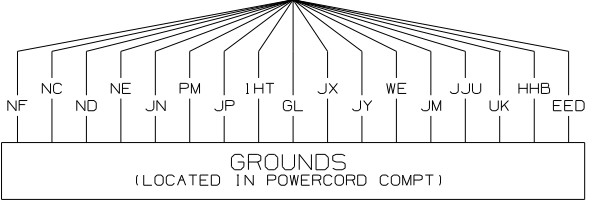
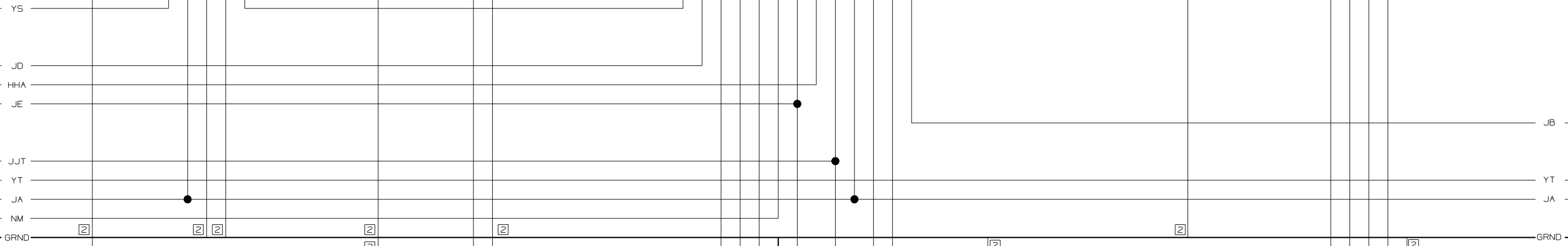

- NC 14 WHT
- ND 14 WHT
- NE 14 WHT
- JN 14 WHT
- PM 14 WHT
- JP 14 WHT
- IHT 16 WHT
- GL 16 WHT
- JX 14 WHT
- JY 12 WHT
- WE 14 WHT
- JM 14 WHT
- JJU 14 WHT
- UK 16 WHT
- HHB 14 WHT
- EED 12 WHT
- NF 14 WHT

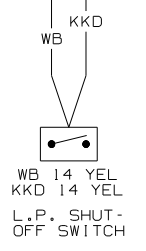
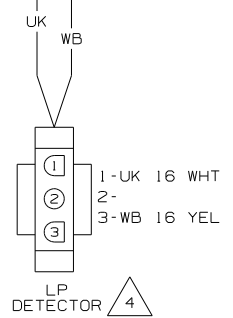

- 1-KKD 16 YEL
- 2-LL 16 WHT
- 3-LM 16 WHT
- 4-LN 16 WHT
- 5-LP 16 YEL
- 6-JE 14 YEL
- 7-ER 16 YEL
- 8-JT 16 YEL
- 9-WC 14 YEL
- 10-WE 14 WHT
- 11-DDT 12 YEL
- 12-DDU 12 WHT
- 13-DDV 12 YEL
- 14-DDW 12 WHT
- 15-JJT 14 YEL

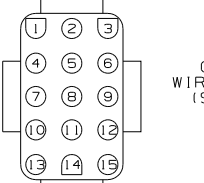

CONNECTS TO WIRE ASM-CHASSIS (SHT 1, A-15) (LOCATED IN BED BASE)

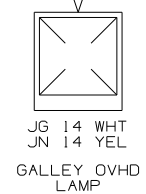
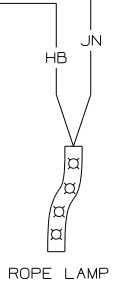
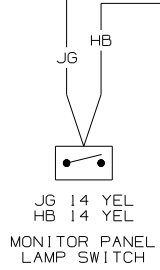
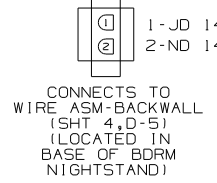

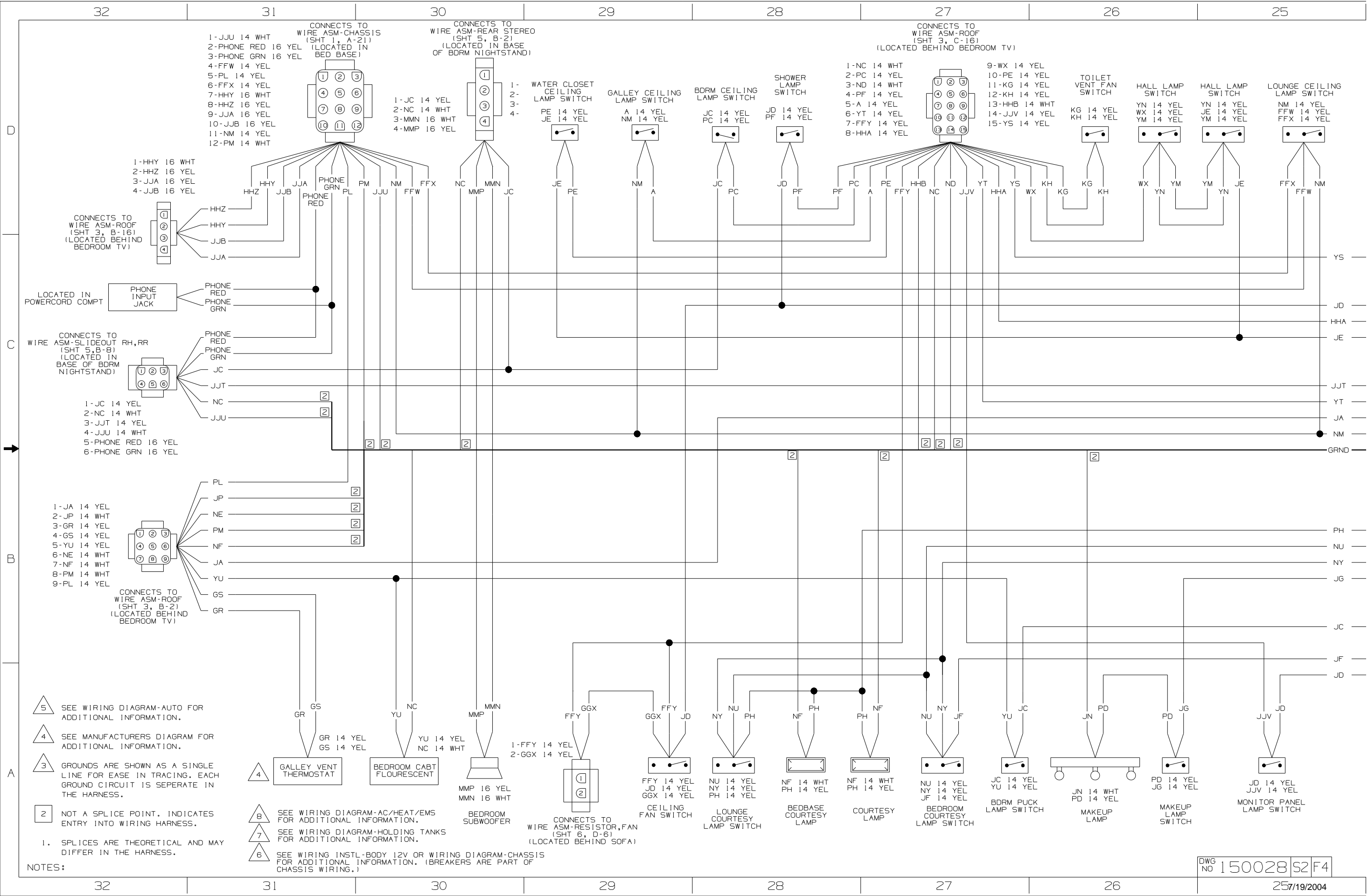

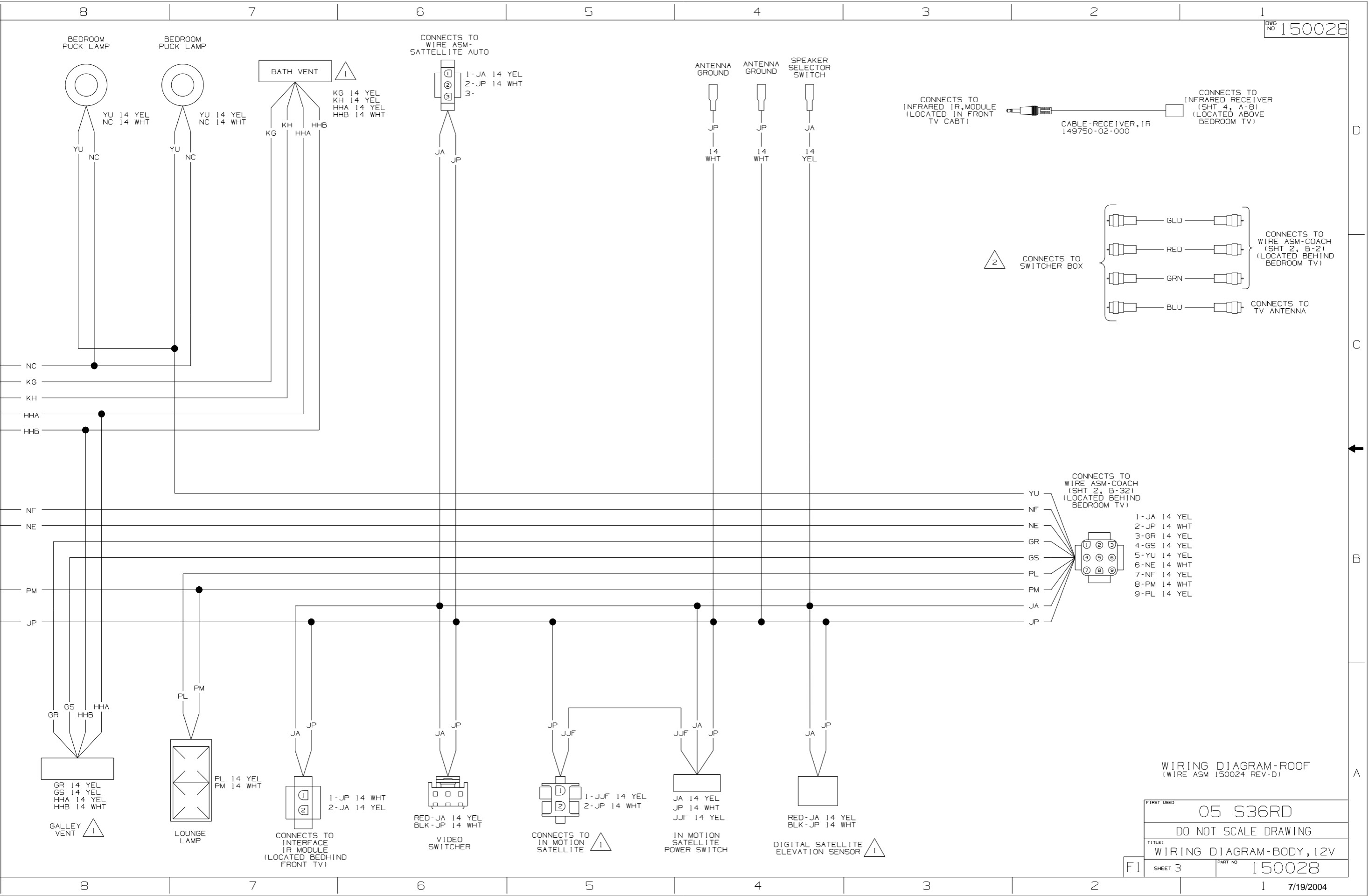

WIRING DIAGRAM-ROOF
(WIRE ASM 150024 REV-D)

FIRST USED	05 S36RD	
TITLE	DO NOT SCALE DRAWING	
	WIRING DIAGRAM-BODY, 12V	
F1 SHEET 3	PART NO	150028

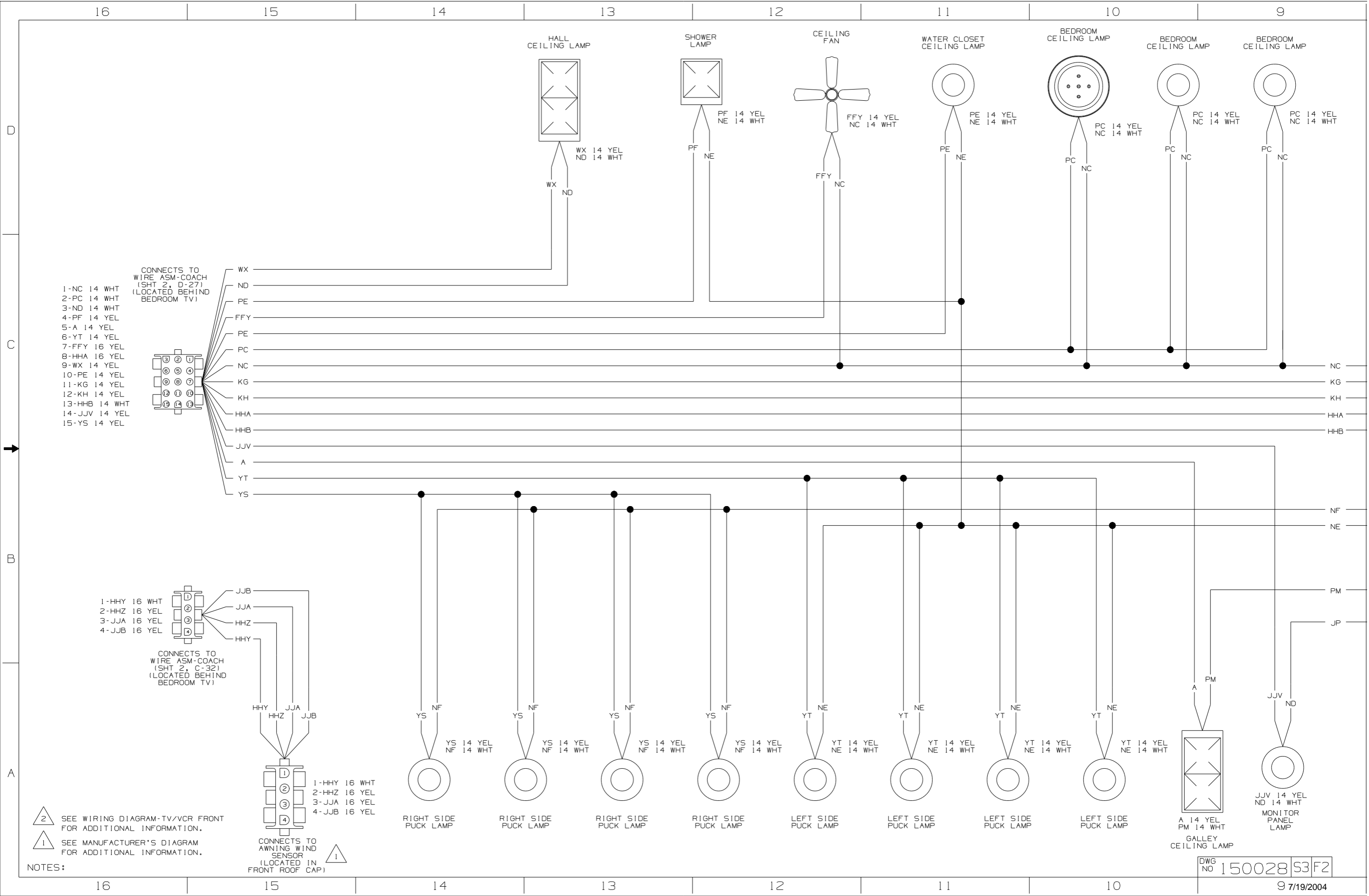

- CONNECTS TO WIRE ASM-COACH (SHT 2, D-27) (LOCATED BEHIND BEDROOM TV)
- 1-NC 14 WHT
 - 2-PC 14 WHT
 - 3-ND 14 WHT
 - 4-PF 14 YEL
 - 5-A 14 YEL
 - 6-YT 14 YEL
 - 7-FFY 16 YEL
 - 8-HHA 16 YEL
 - 9-WX 14 YEL
 - 10-PE 14 YEL
 - 11-KG 14 YEL
 - 12-KH 14 YEL
 - 13-HHB 14 WHT
 - 14-JJV 14 YEL
 - 15-YS 14 YEL

- CONNECTS TO WIRE ASM-COACH (SHT 2, C-32) (LOCATED BEHIND BEDROOM TV)
- 1-HHY 16 WHT
 - 2-HHZ 16 YEL
 - 3-JJA 16 YEL
 - 4-JJB 16 YEL

NOTES:

2 SEE WIRING DIAGRAM-TV/VCR FRONT FOR ADDITIONAL INFORMATION.

1 SEE MANUFACTURER'S DIAGRAM FOR ADDITIONAL INFORMATION.

CONNECTS TO AWNING WIND SENSOR (LOCATED IN FRONT ROOF CAP)

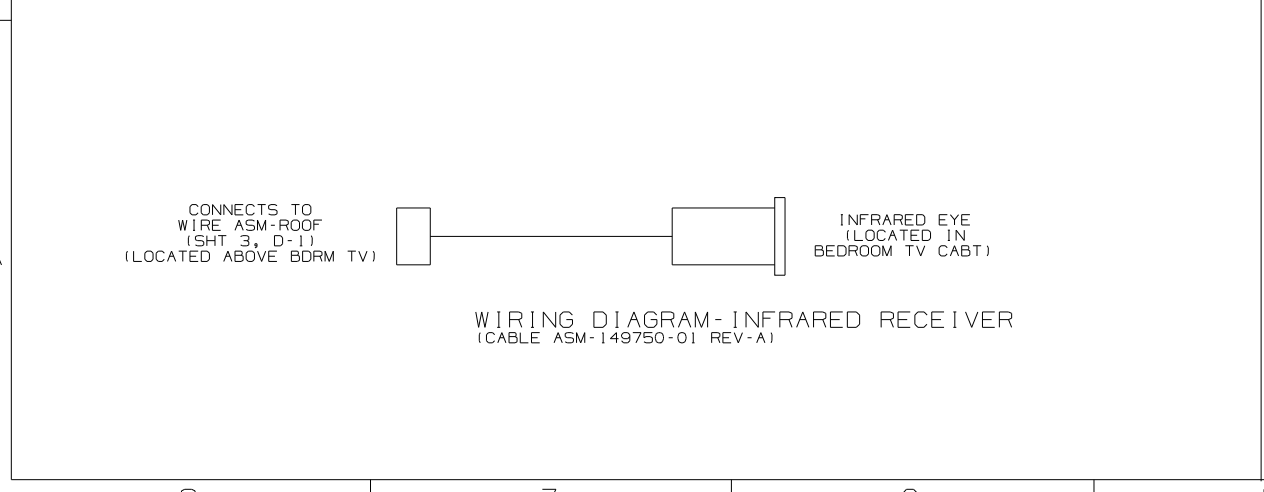
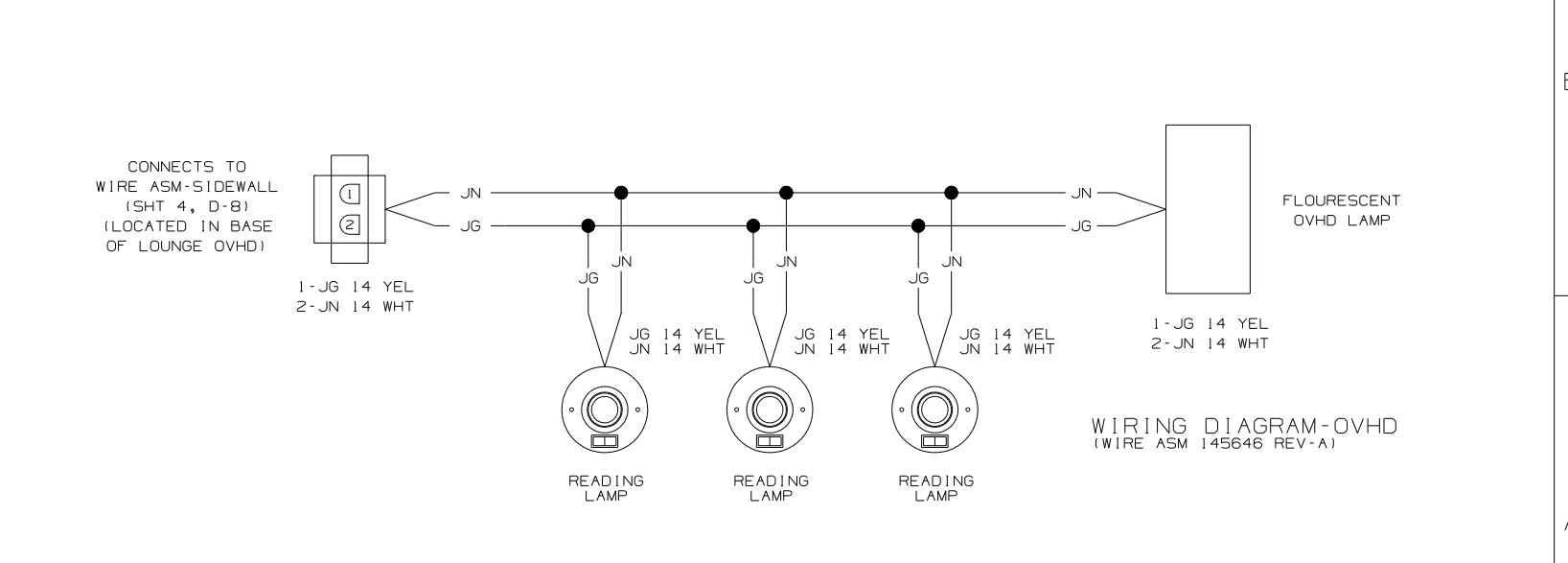
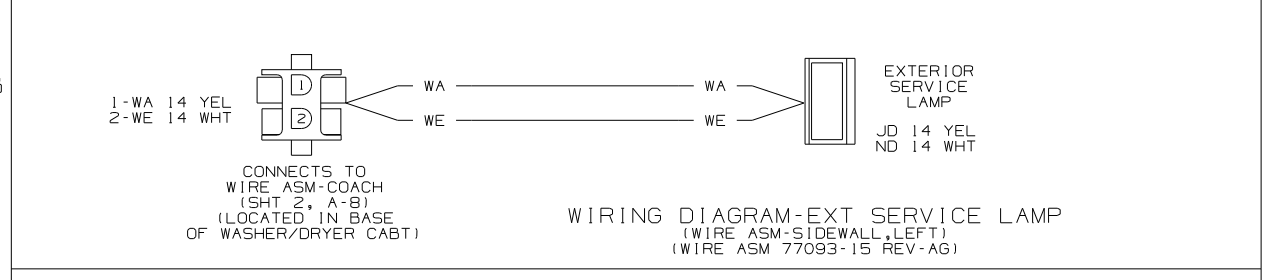
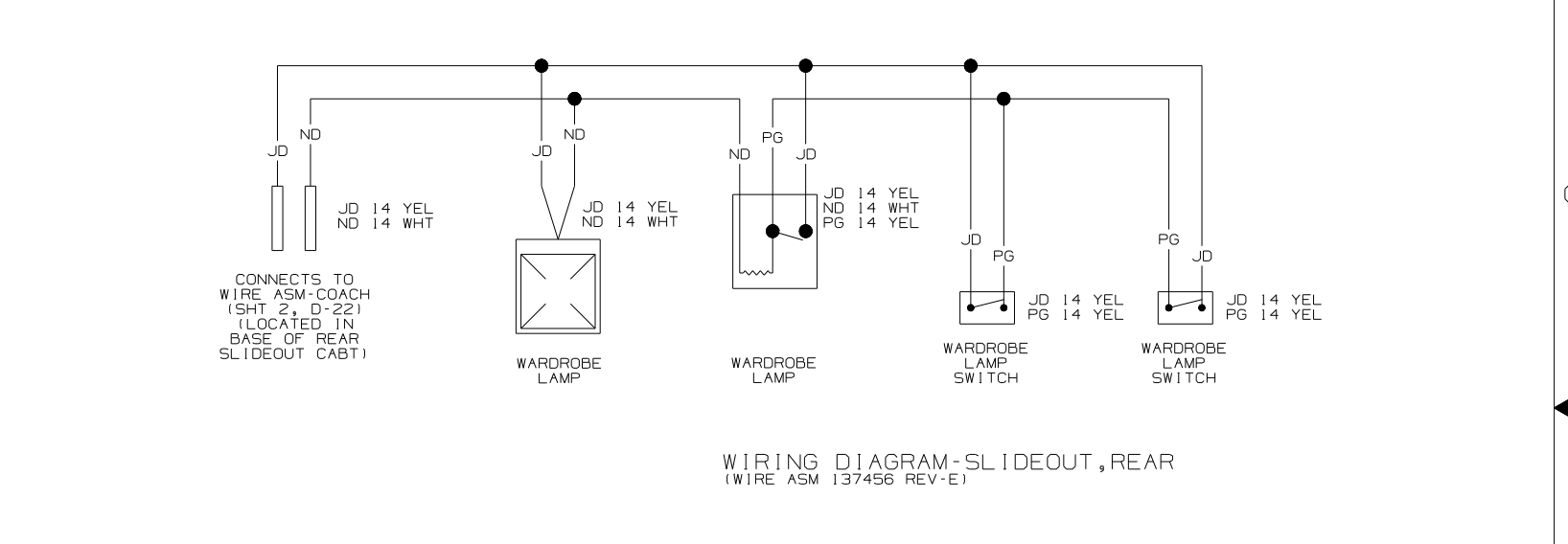
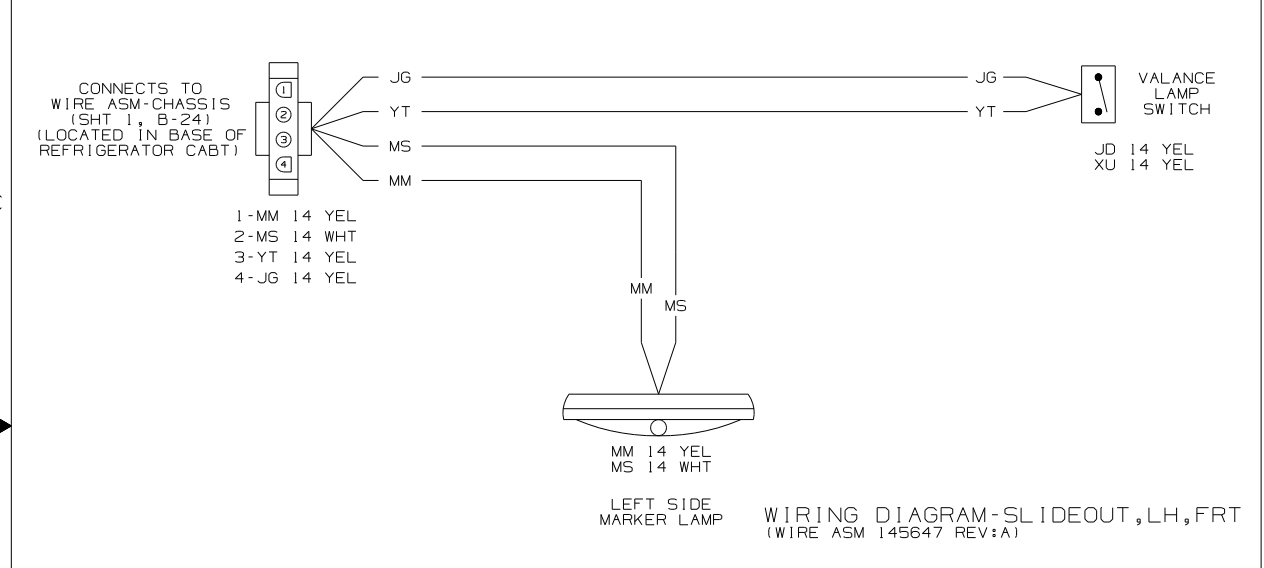
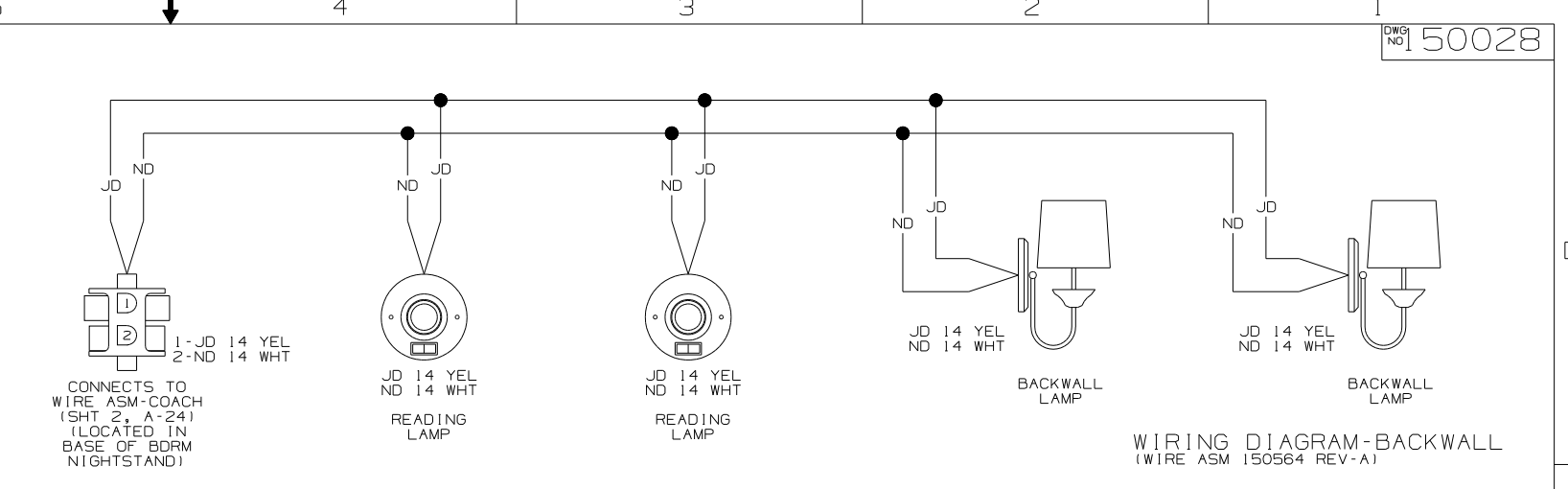
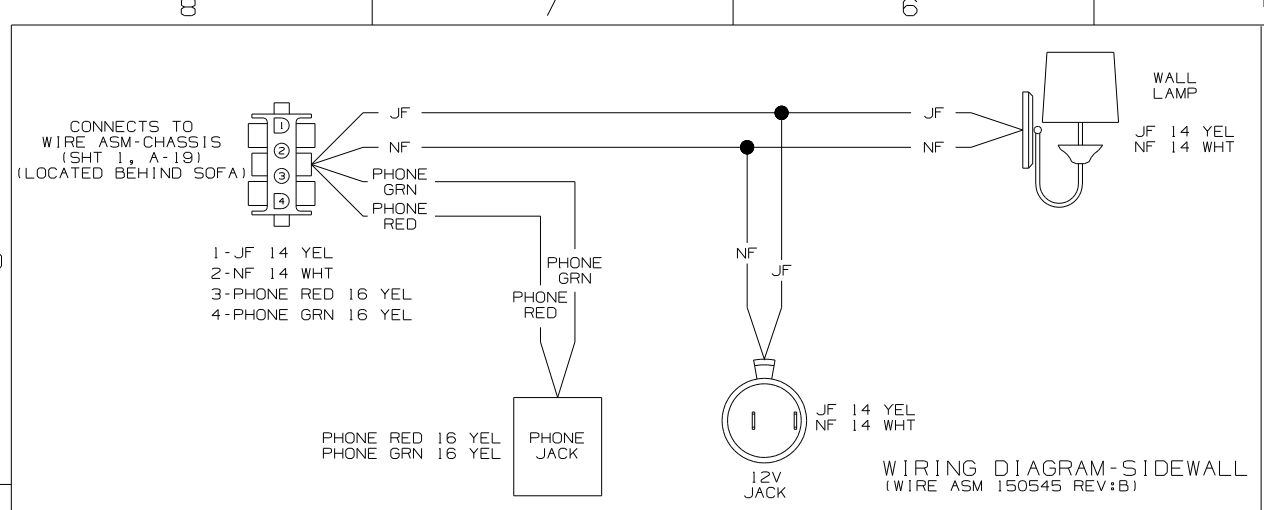

FIRST USED	05 S36RD
TITLE	DO NOT SCALE DRAWING
TITLE	WIRING DIAGRAM-BODY, 12V
SHEET 4	PART NO 150028

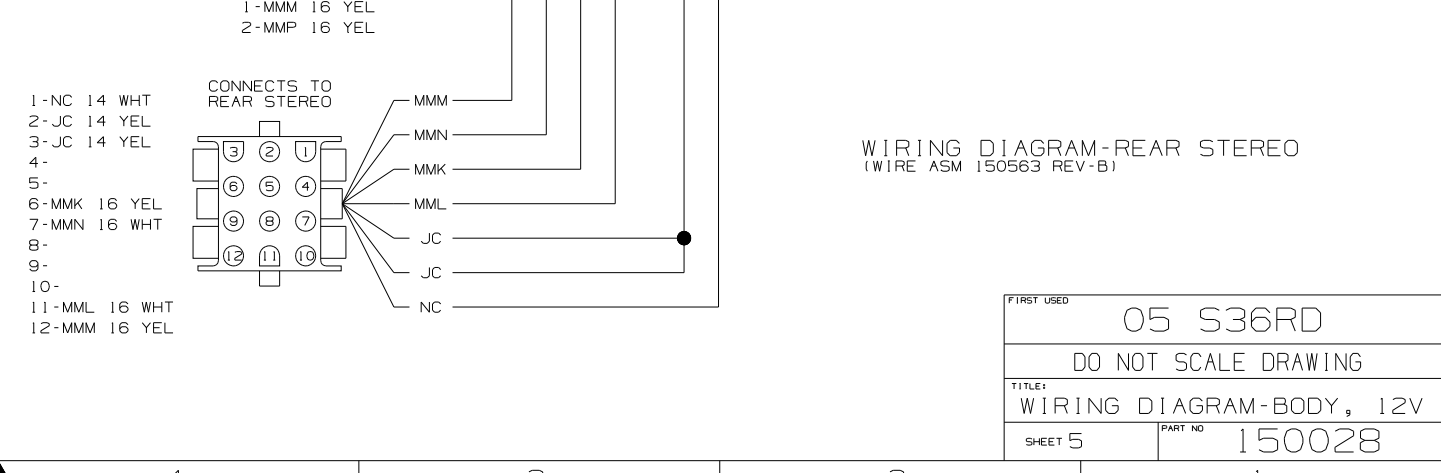
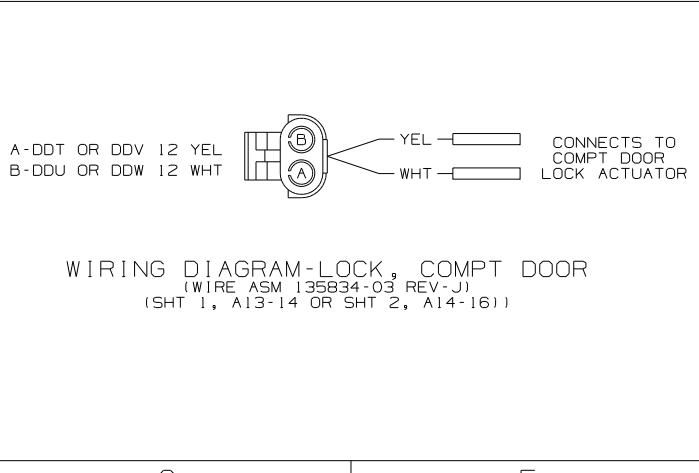
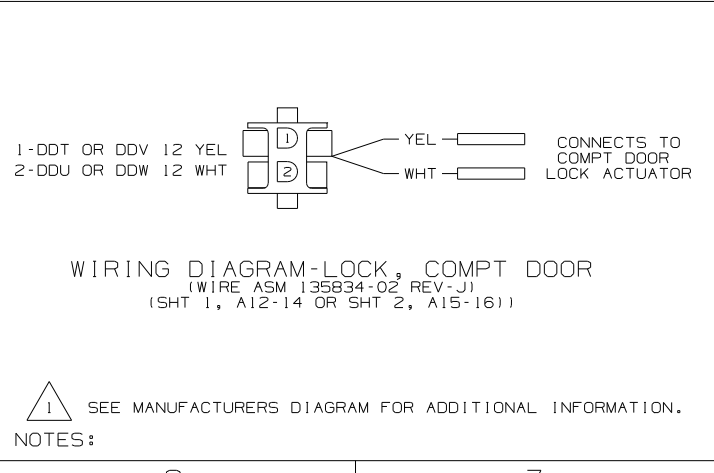
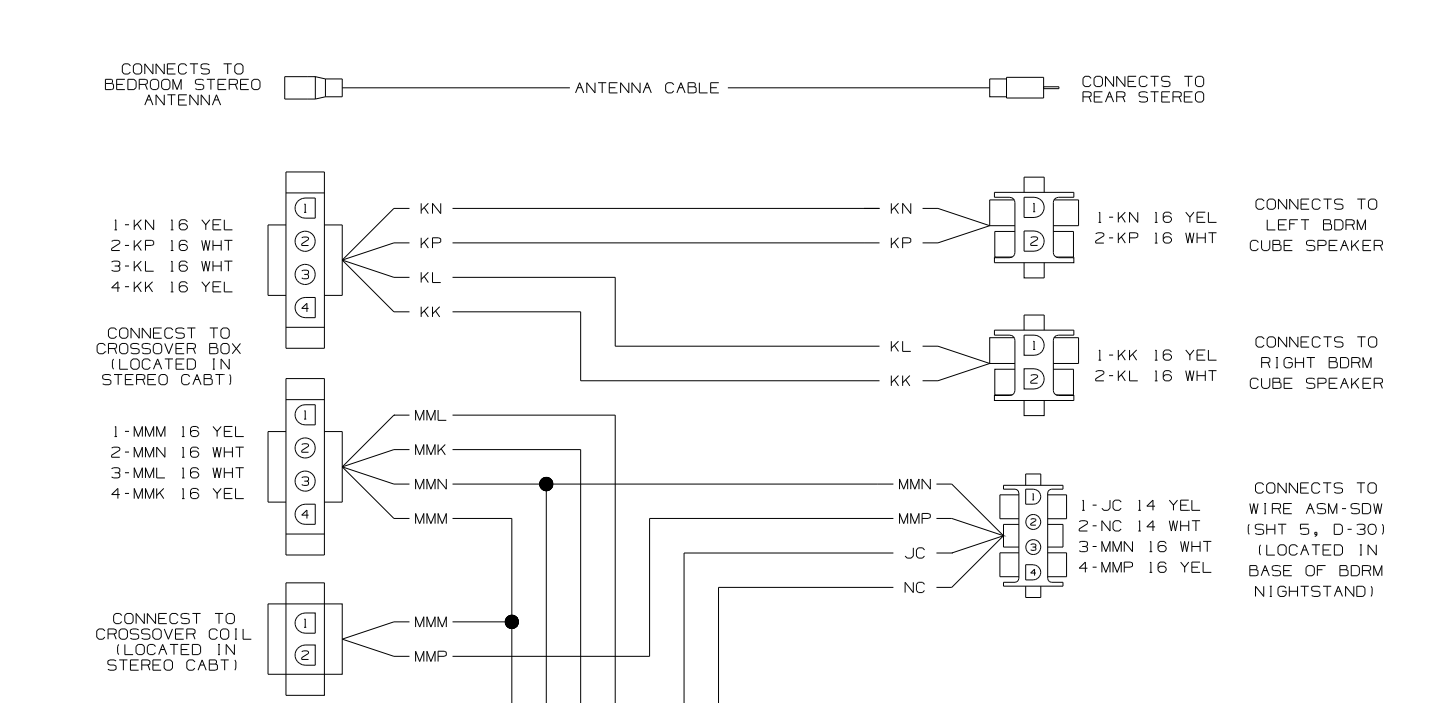
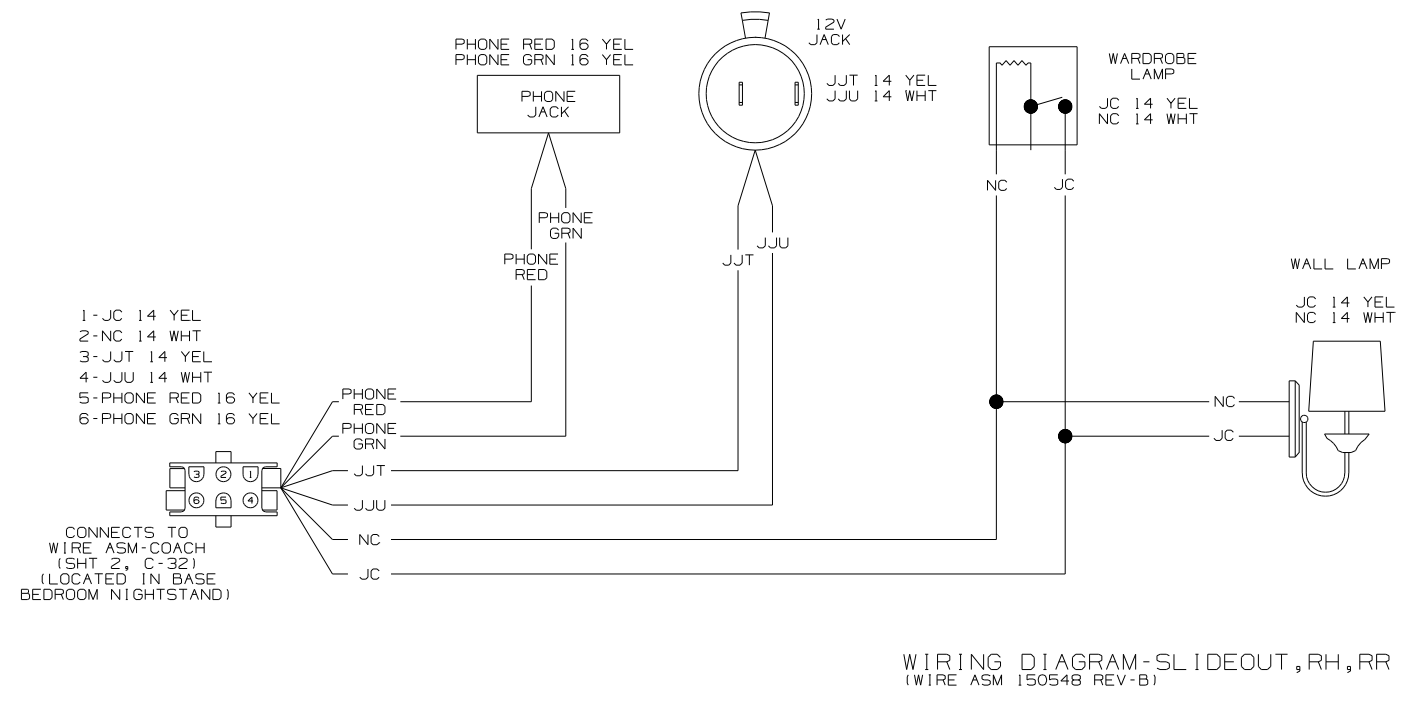
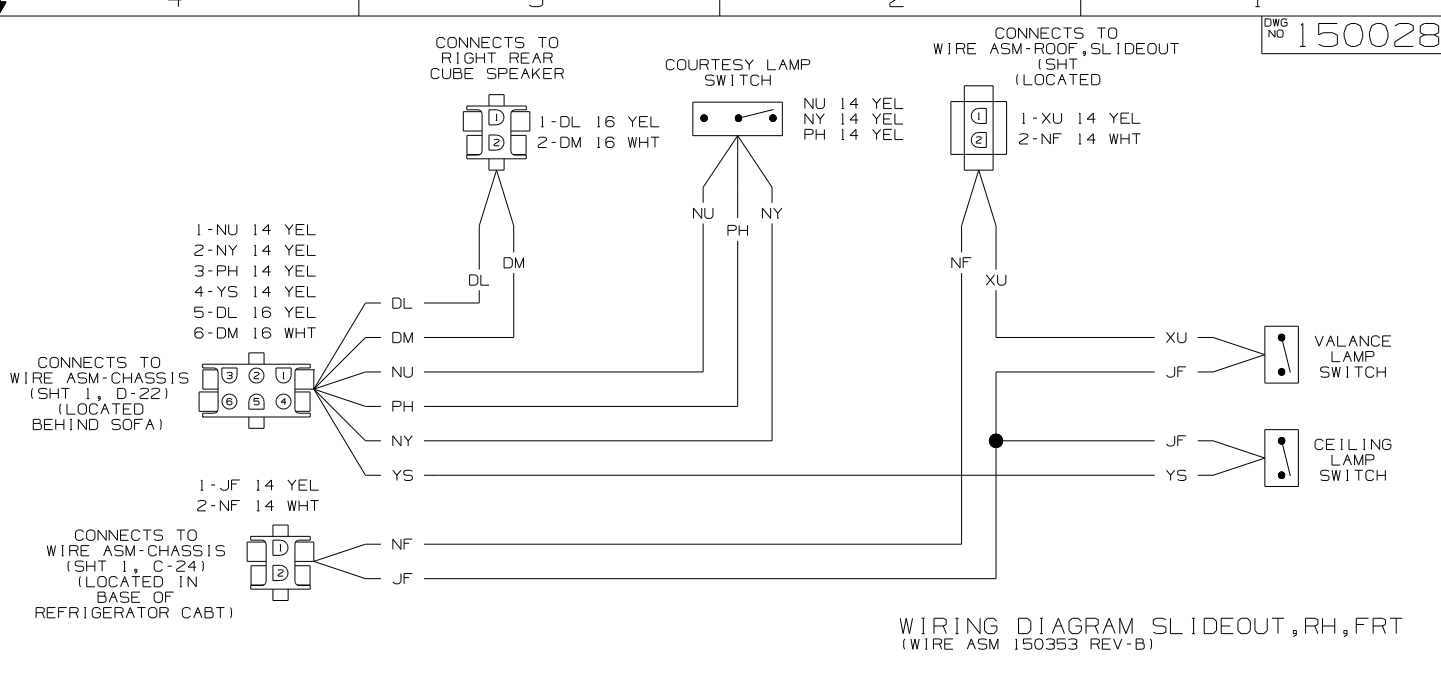
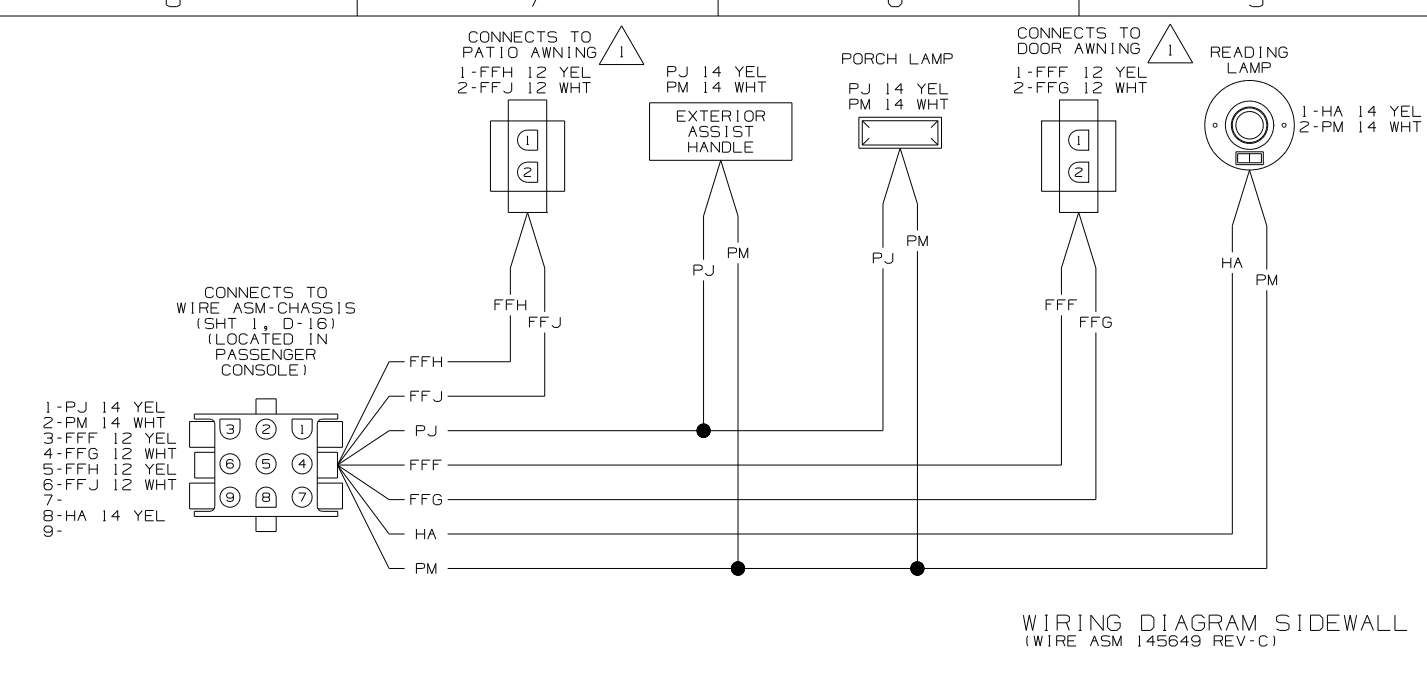

NOTES:
1 SEE MANUFACTURERS DIAGRAM FOR ADDITIONAL INFORMATION.

FIRST USED	05 S36RD
TITLE	DO NOT SCALE DRAWING
TITLE	WIRING DIAGRAM-BODY, 12V
SHEET 5	PART NO 150028
1 7/19/2004	

CONNECTS TO WIRE ASM-SOFA, DBL REST EASY (SHT 6, D-5) (LOCATED BEHIND SOFA)

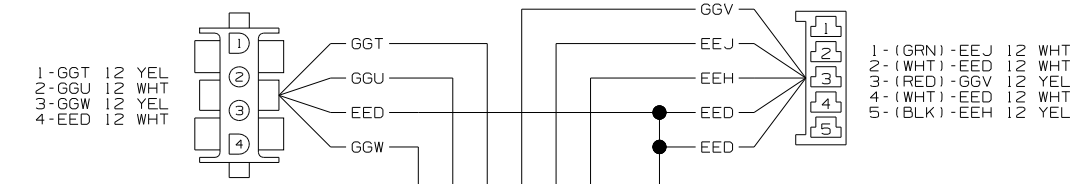

FRONT RELAY
30-EEC 12 YEL
85-EEJ 12 WHT
86-EEH 12 YEL
87-87A-GGW 12 YEL

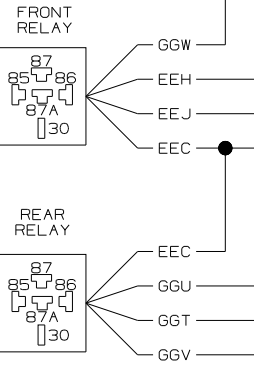

WIRING DIAGRAM-SOFA, DBL REST EASY (WIRE ASM 139583-01 REV-D)

CONNECTS TO WIRE ASM-SIDEWALL (SHT 6, A-6) (LOCATED BEHIND SOFA)

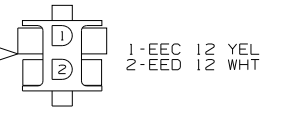

CONNECTS TO HEAT/VIBRATOR WIRES (LOCATED BEHIND SOFA)



CONNECTS TO WIRE ASM-SOFA, DBL REST EASY (SHT 6, D-8) (LOCATED BEHIND SOFA)

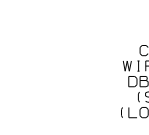

WIRING DIAGRAM-SOFA, DBL REST EASY (WIRE ASM 139583-02 REV-D)

CONNECTS TO RECLINER SWITCH REAR

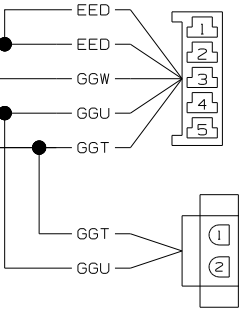

CONNECTS TO REAR MOTOR WIRING (LOCATED BEHIND SOFA)

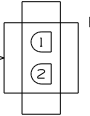

CONNECTS TO MOTOR WIRING (LOCATED BEHIND SOFA)

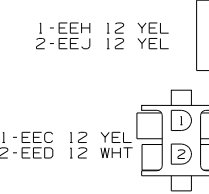

CONNECTS TO WIRE ASM-SIDEWALL (SHT 6, A-6) (LOCATED BEHIND SOFA)

WIRING DIAGRAM-SOFA, REST EASY (WIRE ASM 136028 REV-A)

CONNECTS TO RECLINER SWITCH REAR

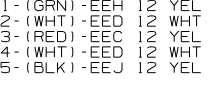

CONNECTS TO EXT ENT CTR RADIO/DVD PLAYER (RCA CONNECTIONS)

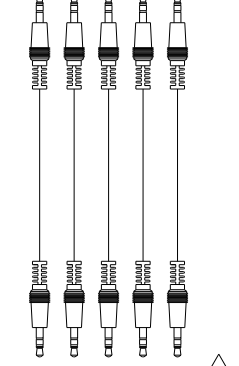

CONNECTS TO CROSSOVER BOX (LOCATED BEHIND EXT ENT CTR RADIO)

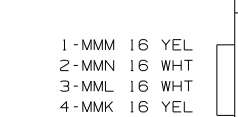

CONNECTS TO CROSSOVER COIL (LOCATED BEHIND EXT ENT CTR RADIO)

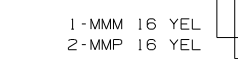

RED-JA 14 YEL
BLK-JP 14 WHT
BRN-MMK 16 YEL
WHT-MMN 16 WHT
ORG-MML 16 WHT
GRY-MMM 16 YEL

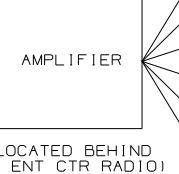

CONNECTS TO WIRE ASM-CHASSIS (SHT 1, B-11) (LOCATED BEHIND EXT ENT CTR RADIO)

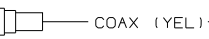

CONNECTS TO EXT ENT CTR TV

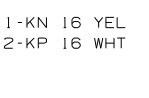
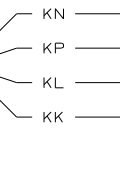

CONNECTS TO LEFT CUBE SPEAKER

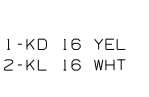
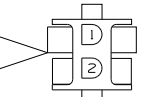

CONNECTS TO RIGHT CUBE SPEAKER

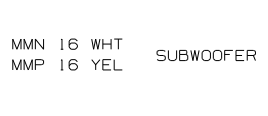

MMN 16 WHT SUBWOOFER
MMP 16 YEL

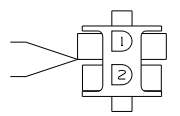

CONNECTS TO WIRE ASM-CHASSIS (SHT 1, D-24) (LOCATED BEHIND EXT ENT CTR RADIO)

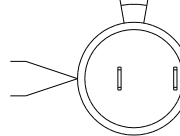

CONNECTS TO WIRE ASM-CHASSIS (SHT 1, D-24) (LOCATED BEHIND EXT ENT CTR RADIO)

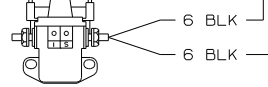
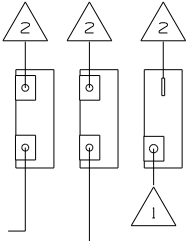

WIRING DIAGRAM-CHASSIS BKR FEED (WIRE ASM 103843-01 REV-J)

CONNECTS TO WIRE ASM-COACH (SHT 2, A-29) (LOCATED BEHIND SWITCH)

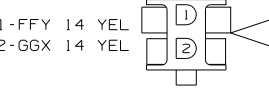

WIRING DIAGRAM-RESISTOR, FAN (WIRE ASM 140195 REV-A)

CONNECTS TO WIRE ASM-CHASSIS (SHT 1, D-24) (LOCATED BEHIND SOFA)

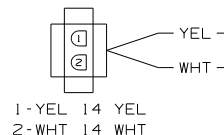

WIRING DIAGRAM-EXTENSION (WIRE ASM 137479-02 REV-D)

CONNECTS TO WIRE ASM-SOFA (SHT 6, D-2 OR C-6) (LOCATED BEHIND SOFA)

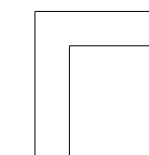
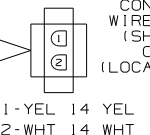

KL 14 WHT RIGHT ENT CTR SPEAKER
KK 14 YEL
KN 14 YEL LEFT ENT CTR SPEAKER
KP 14 WHT

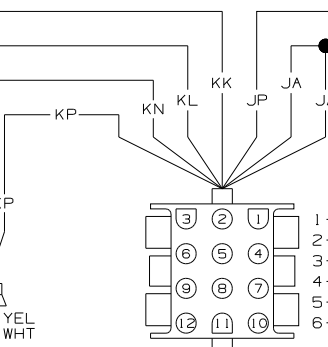

WIRING DIAGRAM-ENTERTAINMENT CENTER (WIRE ASM 125853-04 REV-L)

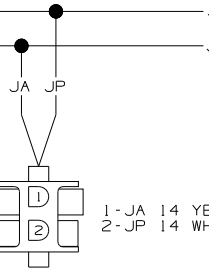

WALLPLATE-TV
JA 14 YEL
JP 14 WHT

WIRING DIAGRAM-ENTERTAINMENT CENTER (WIRE ASM 152217-02 REV-A)

(ID5) ENTERTAINMENT CENTR/EXT W/CD
(ID3) ENTERTAINMENT CENTR/EXT TV-DVD

Table with 2 columns: SHEET 6, PART NO 150028. Includes title 'DO NOT SCALE DRAWING' and 'WIRING DIAGRAM-BODY, 12V'. Date: 7/19/2004.

NOTES:
3 SEE MANUFACTURERS DIAGRAM FOR ADDITIONAL INFORMATION.
2 SEE SHT 2 FOR ADDITIONAL INFORMATION.
1 SEE SHT 1 FOR ADDITIONAL INFORMATION.
4 SEE ENTERTAINMENT CTR COMPL,TV FOR ADDITIONAL INFORMATION.