



DANGER

Danger of electrical shock, burns or death. Always remove all power sources before attempting any repair, service or diagnostic work. Power can be present from shore power, generator, inverter or battery. All power sources must be disabled and secured before performing any service.



CAUTION

If you lack the skills, tools or equipment to perform diagnostic or repair work leave such work to an authorized Winnebago Industries dealer or other qualified shop.

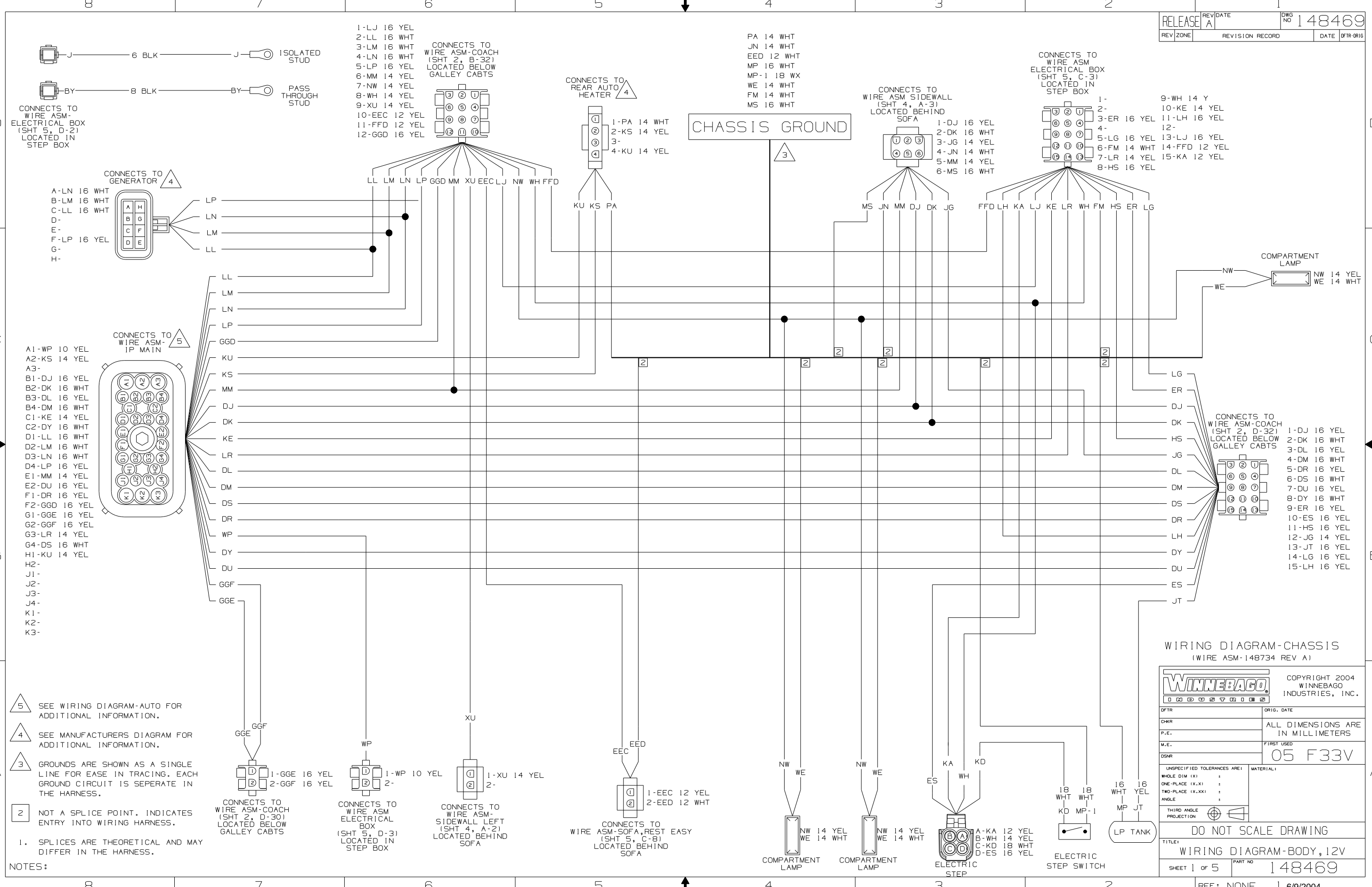

WIRING DIAGRAM-CHASSIS
 (WIRE ASM-148734 REV A)

WINNEBAGO
 COPYRIGHT 2004 WINNEBAGO INDUSTRIES, INC.

DFTR	ORIG. DATE
CHKR	ALL DIMENSIONS ARE IN MILLIMETERS
P.E.	
M.E.	FIRST USED
DSNR	05 F33V

UNSPECIFIED TOLERANCES ARE: MATERIAL:

WHOLE DIM (X) :
 ONE-PLACE (X.X) :
 TWO-PLACE (X.XX) :
 ANGLE :
 THIRD ANGLE PROJECTION

DO NOT SCALE DRAWING

TITLE: WIRING DIAGRAM-BODY, 12V

SHEET 1 of 5 PART NO 148469

REF: NONE 1 6/9/2004

CONNECTS TO WIRE ASM-SIDEWALL (SHT 4, C-7) LOCATED BELOW GALLEY CABTS.

- 1-DL 16 YEL
- 2-DM 16 WHT
- 3-JE 14 YEL
- 4-MM 14 YEL
- 5-MS 14 WHT
- 6-NE 14 WHT
- 7-PJ 14 YEL
- 8-WE 14 WHT
- 9-

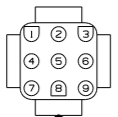

CONNECTS TO WIRE ASM-SIDEWALL (SHT 4, D-8) LOCATED BELOW GALLEY CABTS.

- 1-FFH 12 YEL
- 2-FFJ 12 WHT



CONNECTS TO AWNING CONTROL BOX

- 1-FFD 12 YEL
- 2-FFE 12 WHT
- 3-WH 14 YEL
- 4-
- 5-FFN 12 YEL
- 6-
- 7-
- 8-FFJ 12 WHT
- 9-
- 10-FFR 12 YEL
- 11-
- 12-
- 13-FFH 12 YEL
- 14-
- 15-FFP 12 YEL

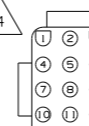

CONNECTS TO AWNING SWITCH

- 1-FFR 12 YEL
- 2-FFP 12 YEL
- 3-FFN 12 YEL
- 4-
- 5-
- 6-
- 7-
- 8-

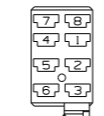

WIRE ASM-SIDEWALL

WIRE ASM-ROOF

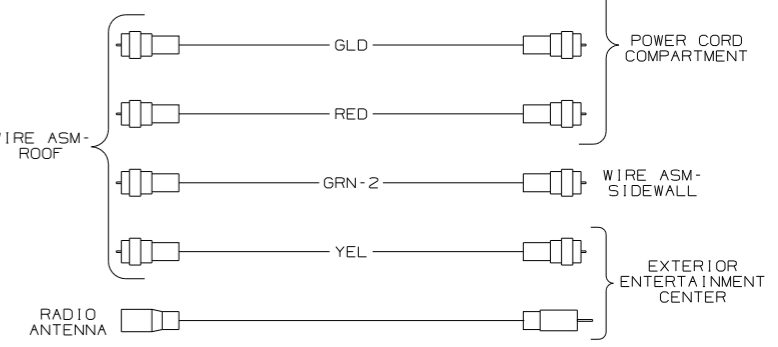

CONNECTS TO FURNACE

- 1-JM 14 WHT
- 2-JJ 14 YEL
- 3-JB 14 YEL
- 4-JH 14 YEL

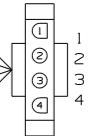

CONNECTS TO LOAD SHEDDER MONITOR PANEL

- 1-BBC 16 YEL
- 2-BBD 16 YEL
- 3-BBE 16 YEL
- 4-BBF 16 YEL

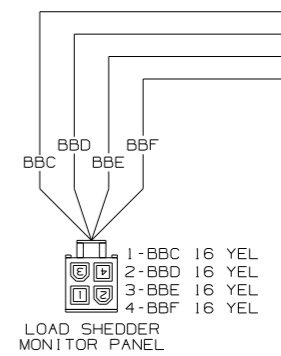

WIRING DIAGRAM-COACH (WIRE ASM-148733 REV D)

FIRST USED	05 F33V
TITLE	DO NOT SCALE DRAWING
TITLE	WIRING DIAGRAM-BODY, 12V
SHEET 2	PART NO 148469



CONNECTS TO REAR THERMOSTAT

- 1-DD 16 YEL
- 2-BBH 16 YEL
- 3-JP 14 WHT
- 4-GGS 16 YEL

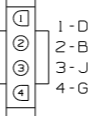

CONNECTS TO LOAD SHEDDER CONTROL BOARD

- 1-JA 12 YEL
- 2-JP 14 WHT
- 3-
- 4-BBJ 16 YEL
- 5-DD 16 YEL
- 6-BBH 16 YEL
- 7-JA 12 YEL
- 8-LP 16 YEL

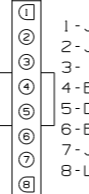

CONNECTS TO EXTERIOR ENTERTAINMENT CENTER

- 1-JA 12 YEL
- 2-JP 14 WHT



- 1-PD 14 YEL
- 2-PE 14 YEL
- 3-PF 14 YEL
- 4-PL 14 YEL
- 5-WX 14 YEL
- 6-XP 16 YEL
- 7-XR 16 YEL
- 8-XS 16 YEL
- 9-BBJ 16 YEL
- 10-GGR 16 YEL
- 11-GGS 16 YEL
- 12-

CONNECTS TO WIRE ASM-ROOF (SHT 3, C-16) LOCATED BEHIND MONITOR PANEL

LOUNGE CEILING LAMP SWITCH

CONNECTS TO WIRE ASM-SIDEWALL (SHT 5, A-8) LOCATED BELOW HEAD OF BED

12V BREAKER PANEL

- WB 16 YEL
- WC 14 YEL
- EEC 12 YEL
- JA 12 YEL
- JB 14 YEL
- JC 14 YEL
- JD 14 YEL
- JE 14 YEL
- JF 14 YEL
- NM 14 YEL
- ET 16 YEL
- JG 14 YEL
- M 6 BLK

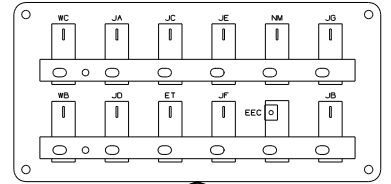

MAKEUP LAMP SWITCH

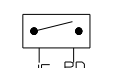

PORCH STEP LAMP SWITCH

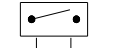

STEP LAMP



COMPARTMENT LAMP

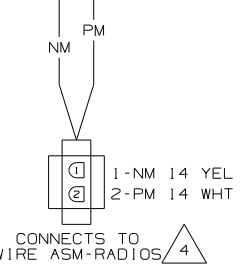
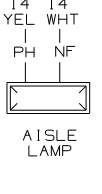
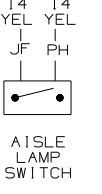
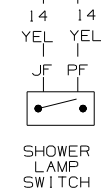
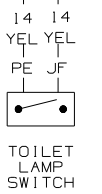
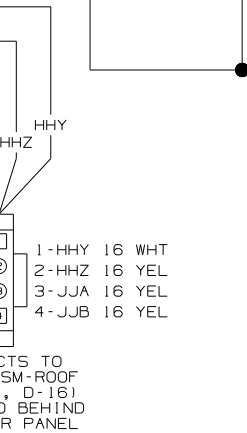
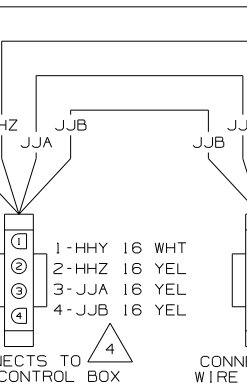
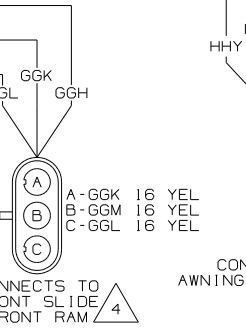
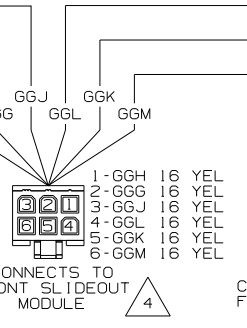
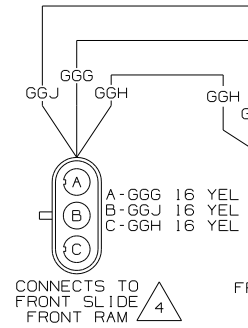
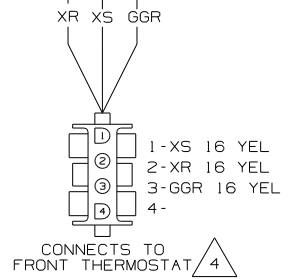
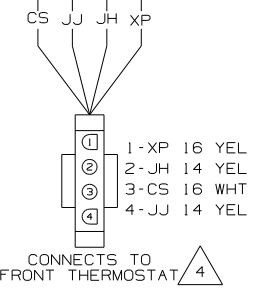
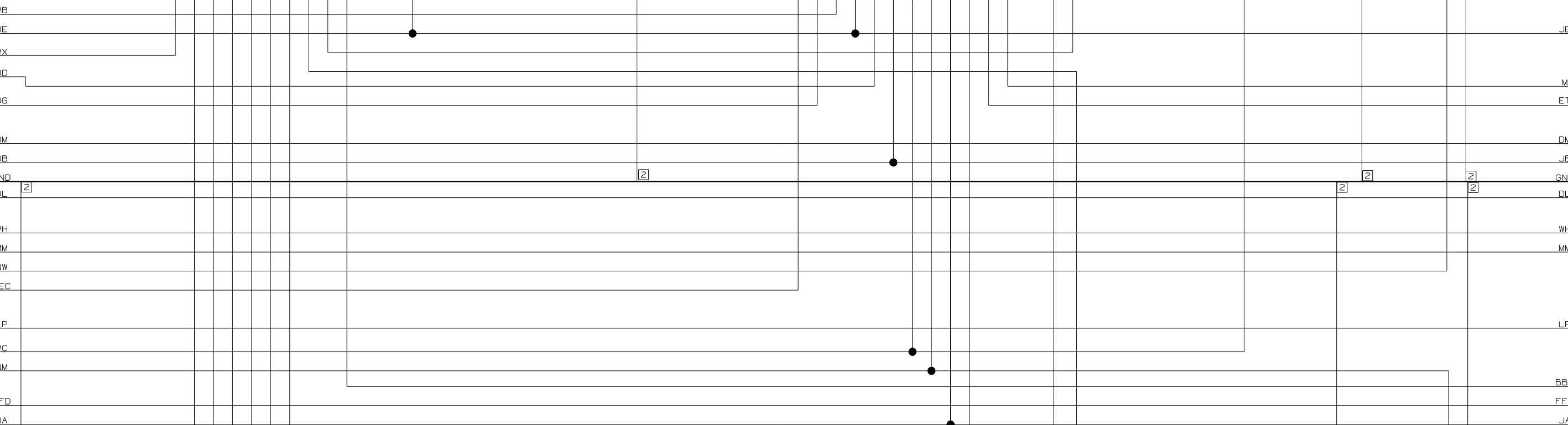

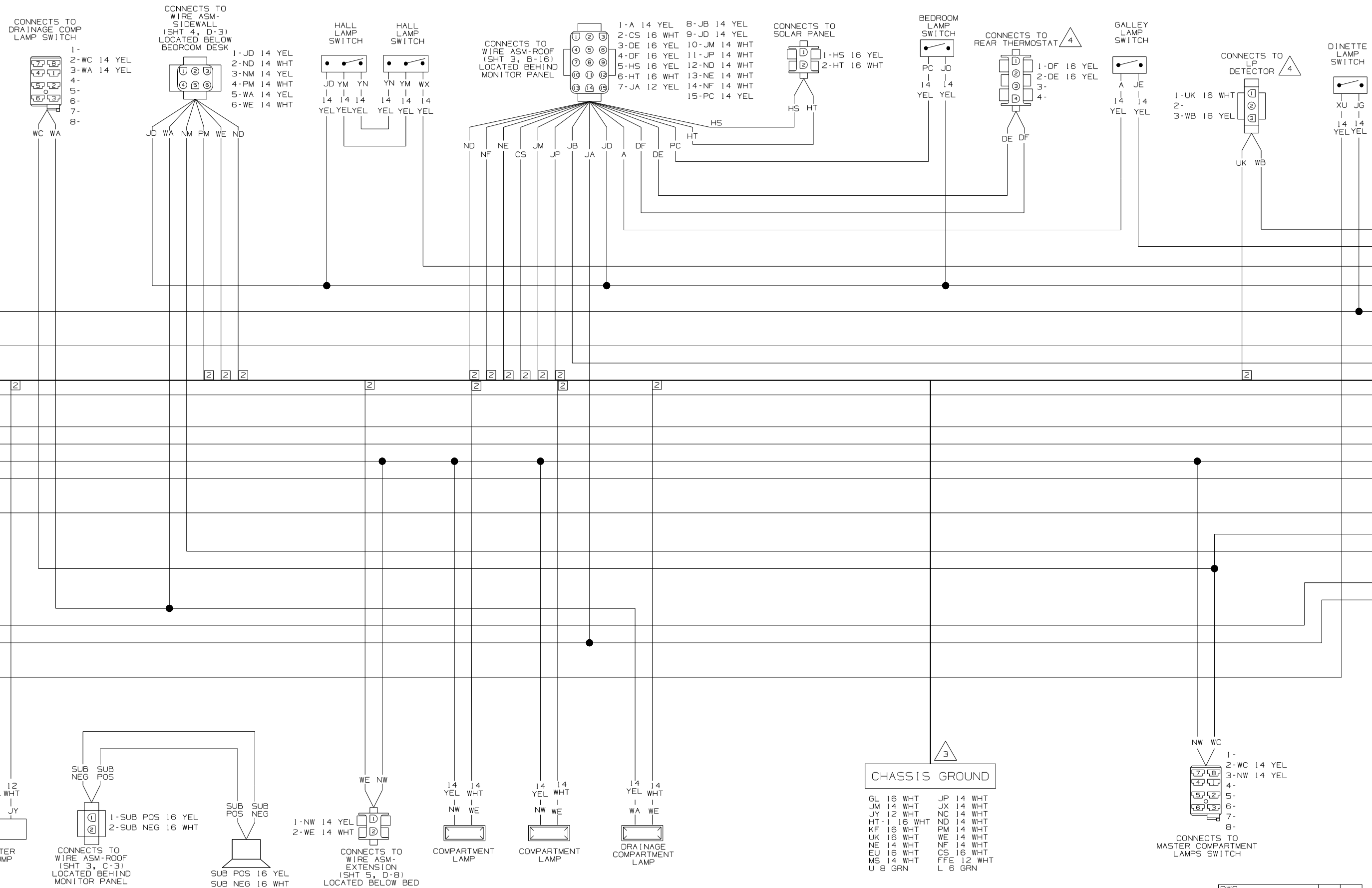

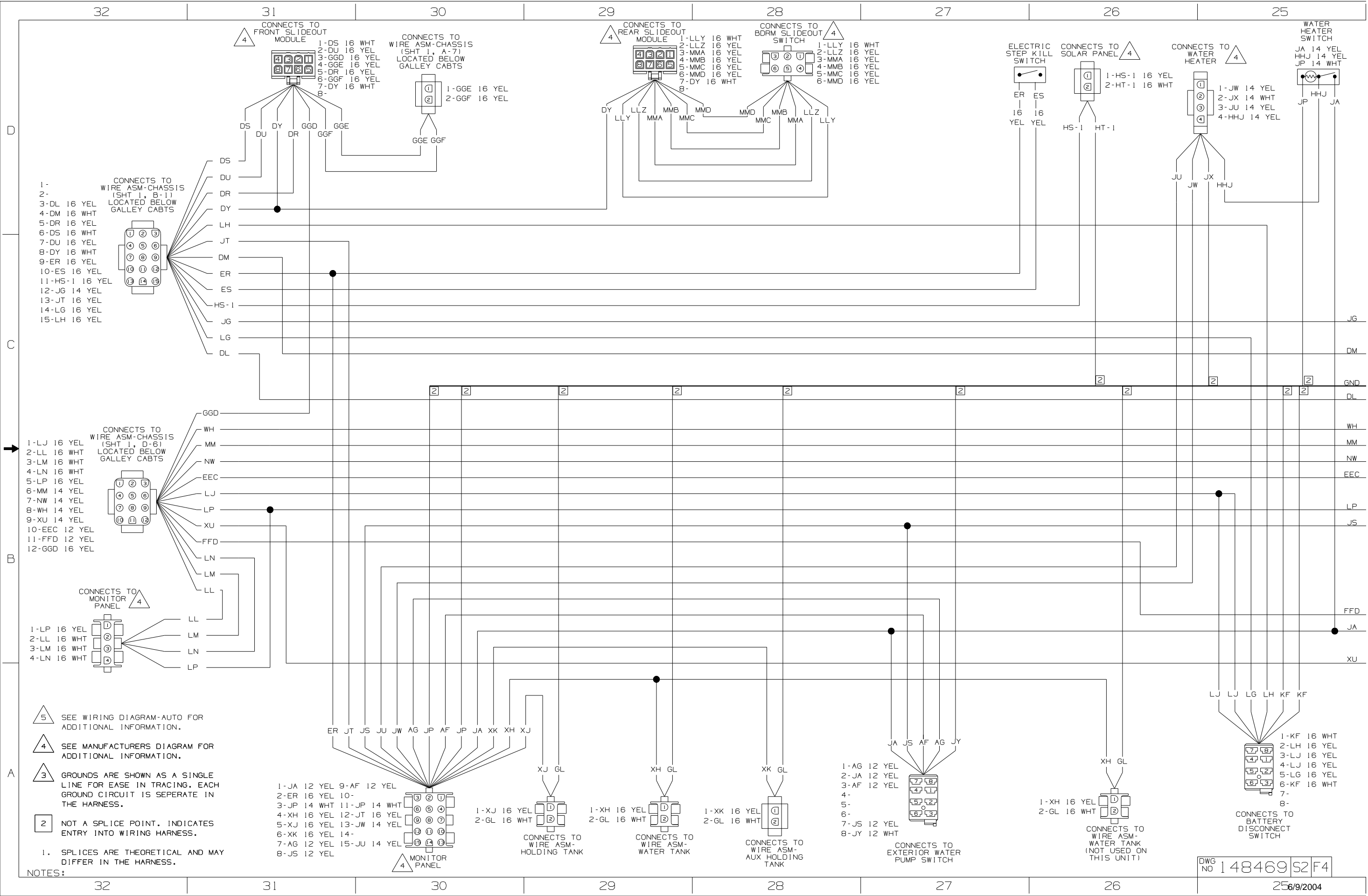

TOILET
CEILING
LAMP

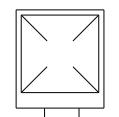

PF NF
14 14
YEL WHT

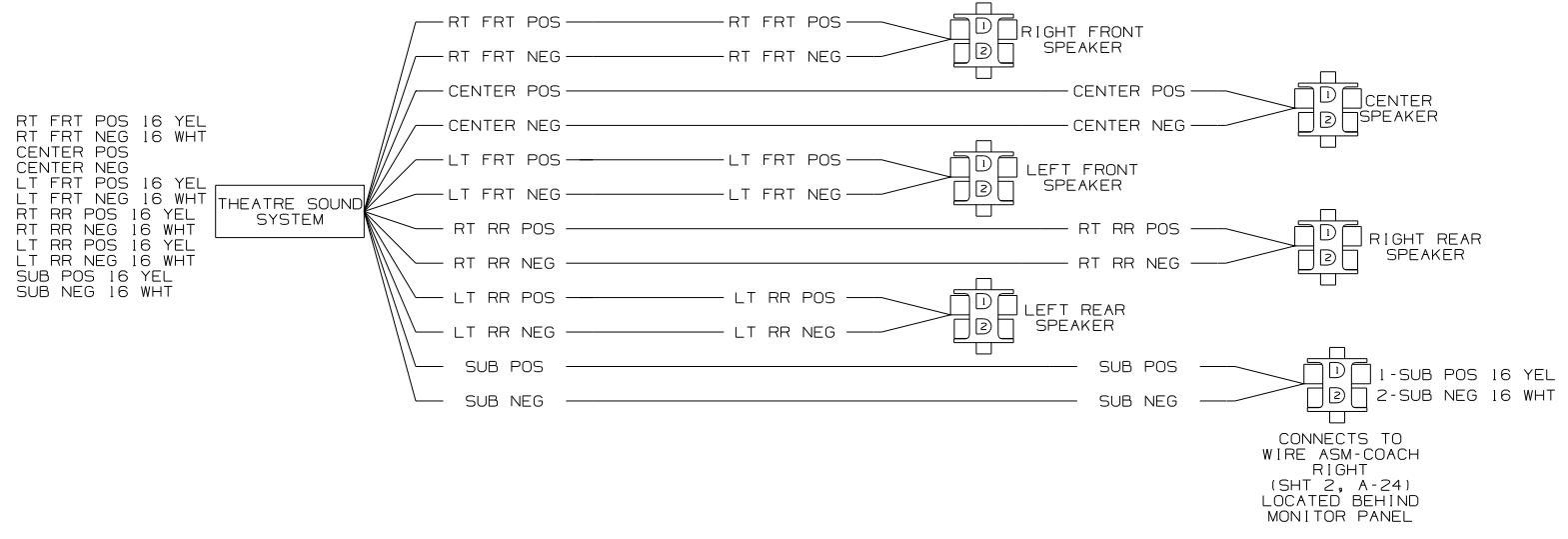

14 14
WHT YEL
NE A

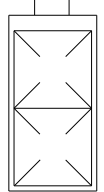

GALLEY
CEILING
LAMP

14 14
WHT YEL
NE A

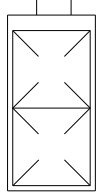

DINETTE
CEILING
LAMP

14 14
WHT YEL
ND PC

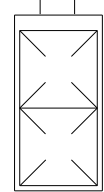

BEDROOM
CEILING
LAMP

14 14
YEL WHT
PC ND

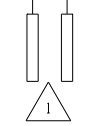

14 14 14
YEL YEL WHT
JD PG ND

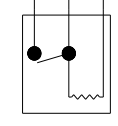

WARDROBE
LAMP

14 14
YEL YEL
PG JD

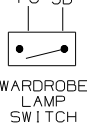

WARDROBE
LAMP
SWITCH

14 14 14
YEL YEL WHT
JD PG ND

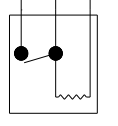

WARDROBE
LAMP

WIRING DIAGRAM-ROOF
(WIRE ASM 148732 REV F)

FIRST USED	05 F33V
TITLE	DO NOT SCALE DRAWING
	WIRING DIAGRAM-BODY, 12V
SHEET 3	PART NO 148469

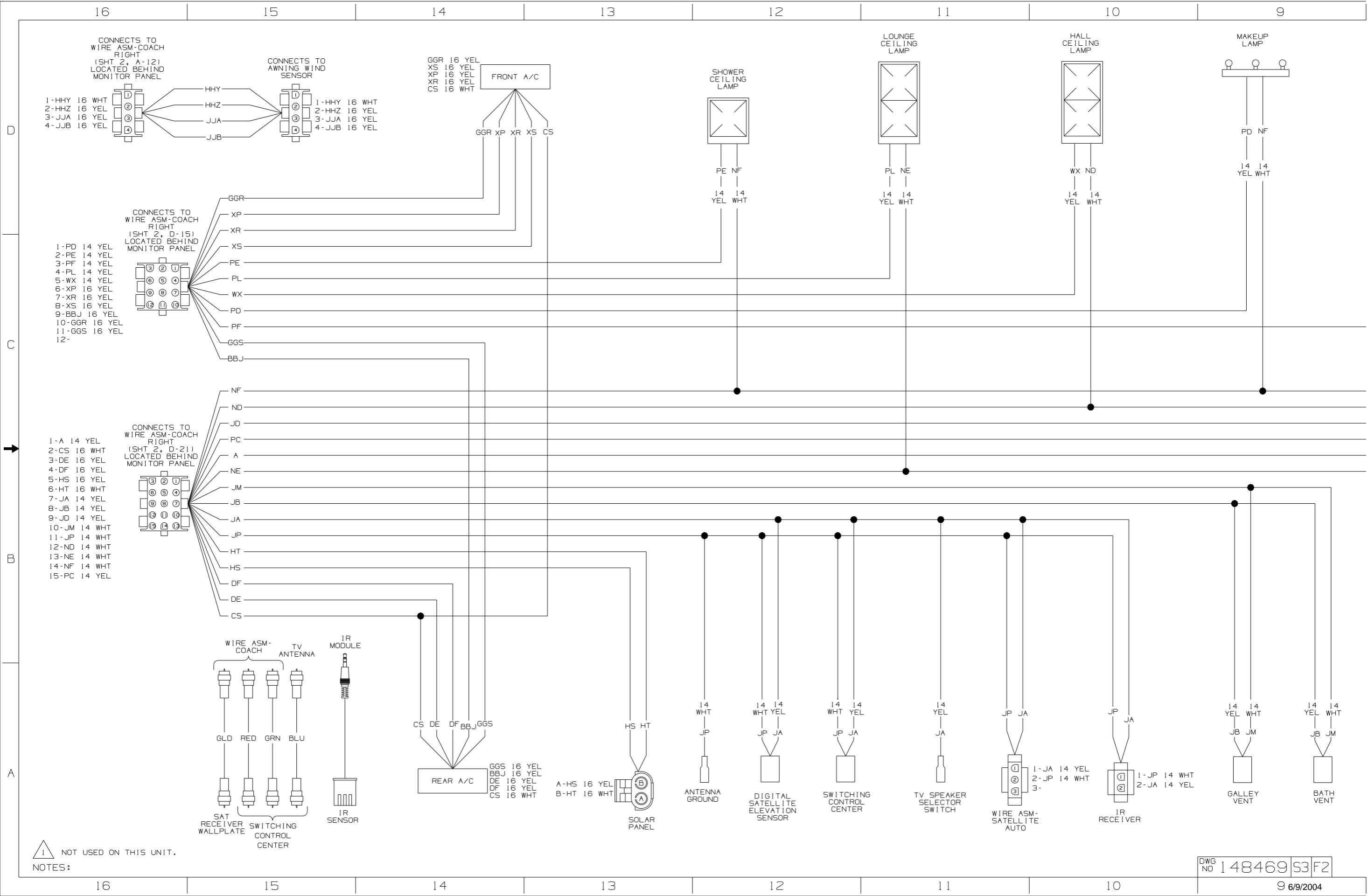

NOTES:
 1 NOT USED ON THIS UNIT.

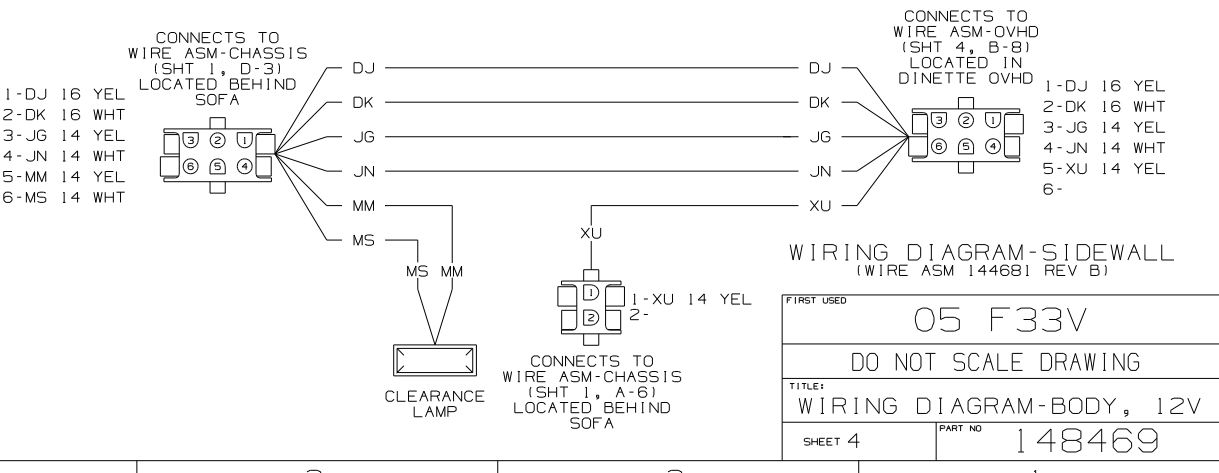
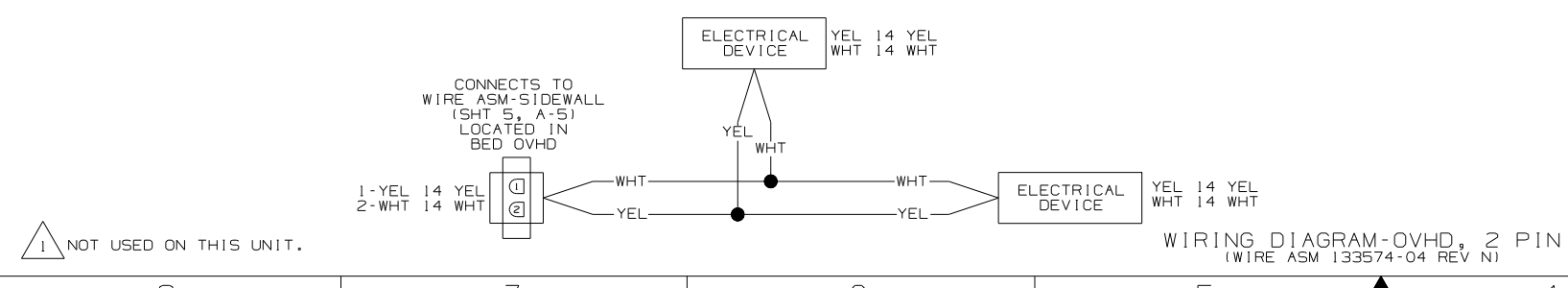
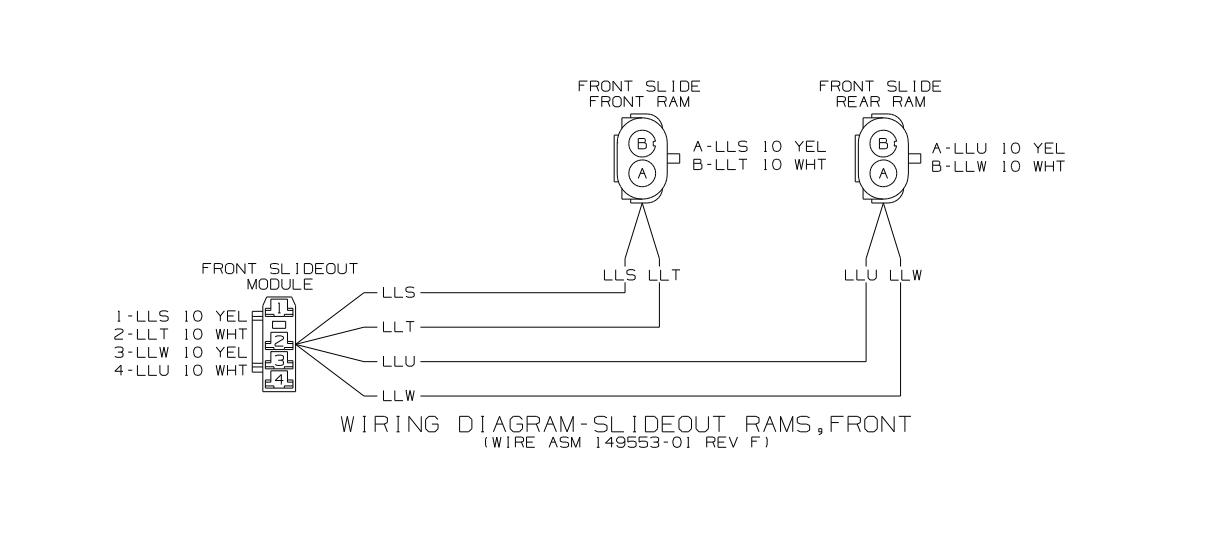
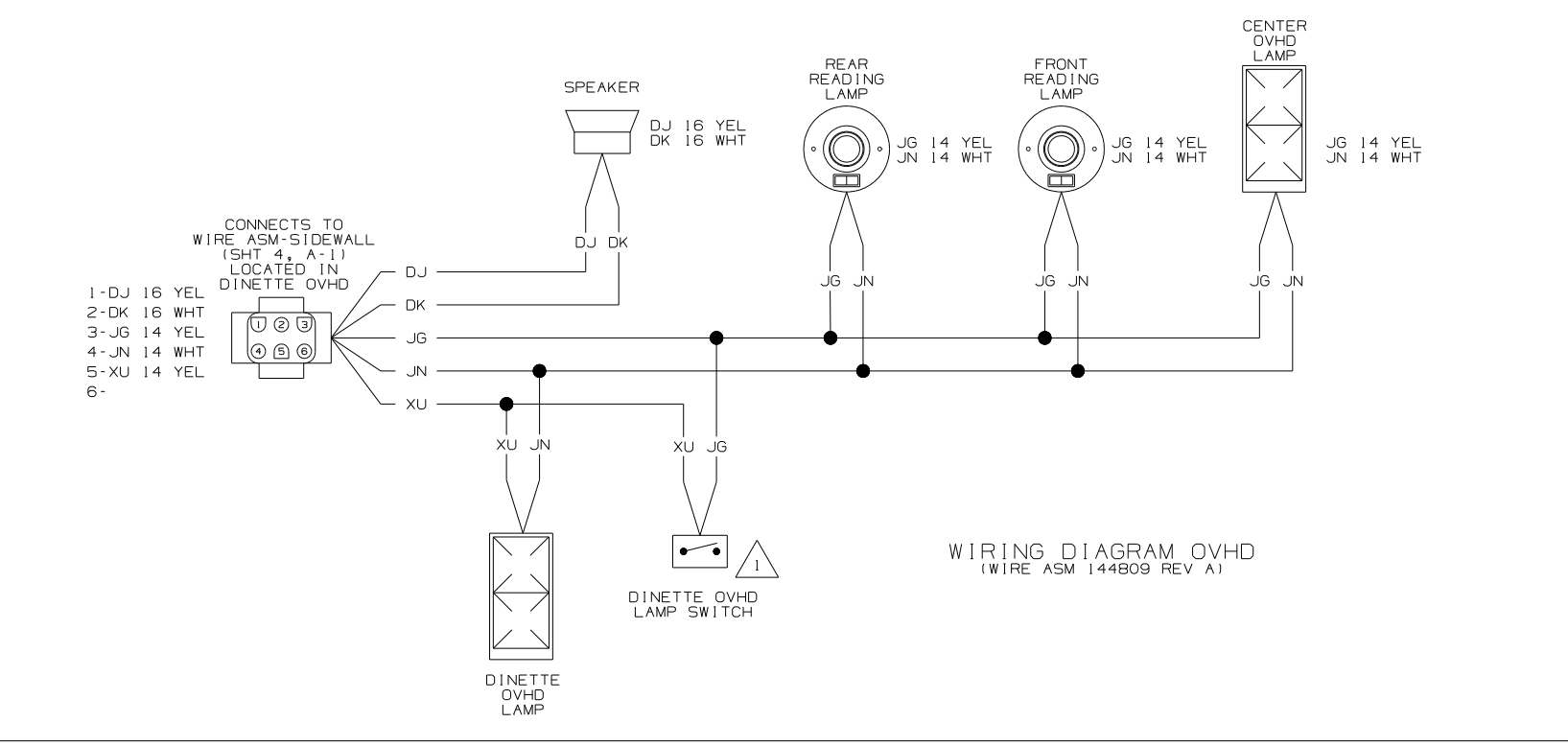
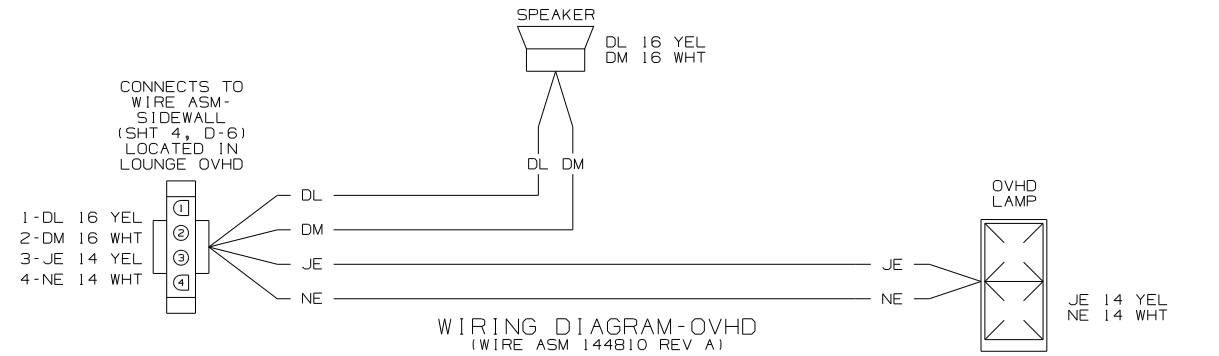
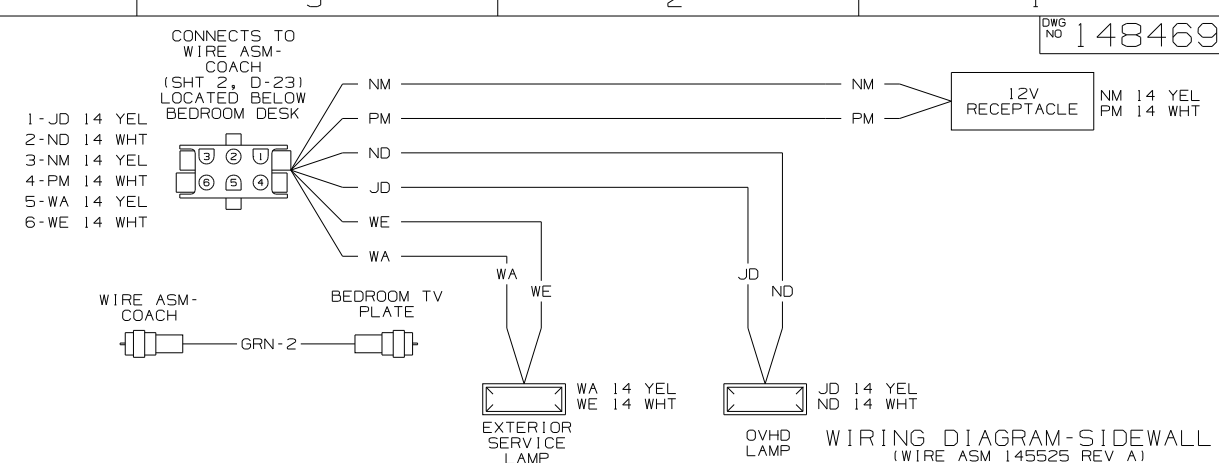
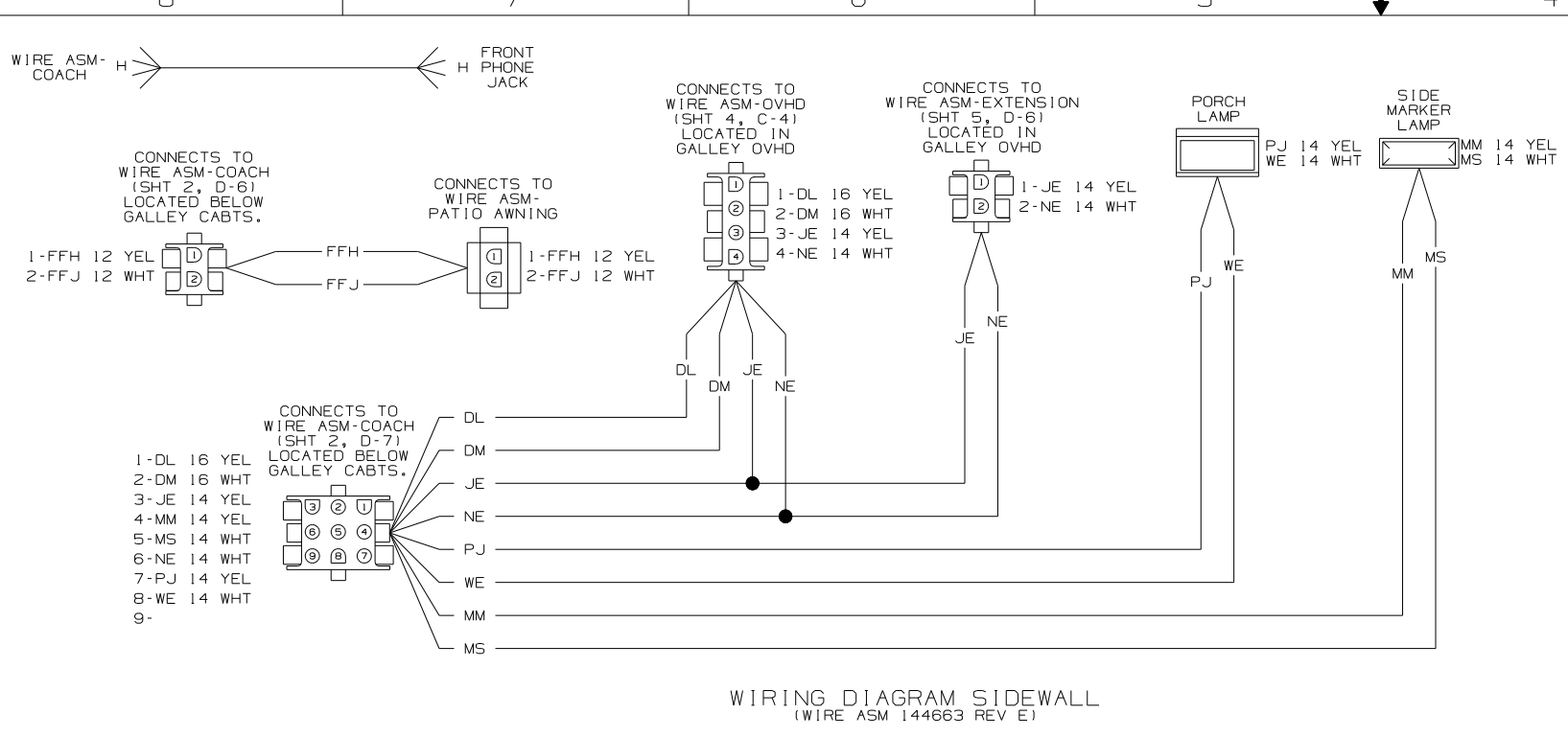

NOT USED ON THIS UNIT.

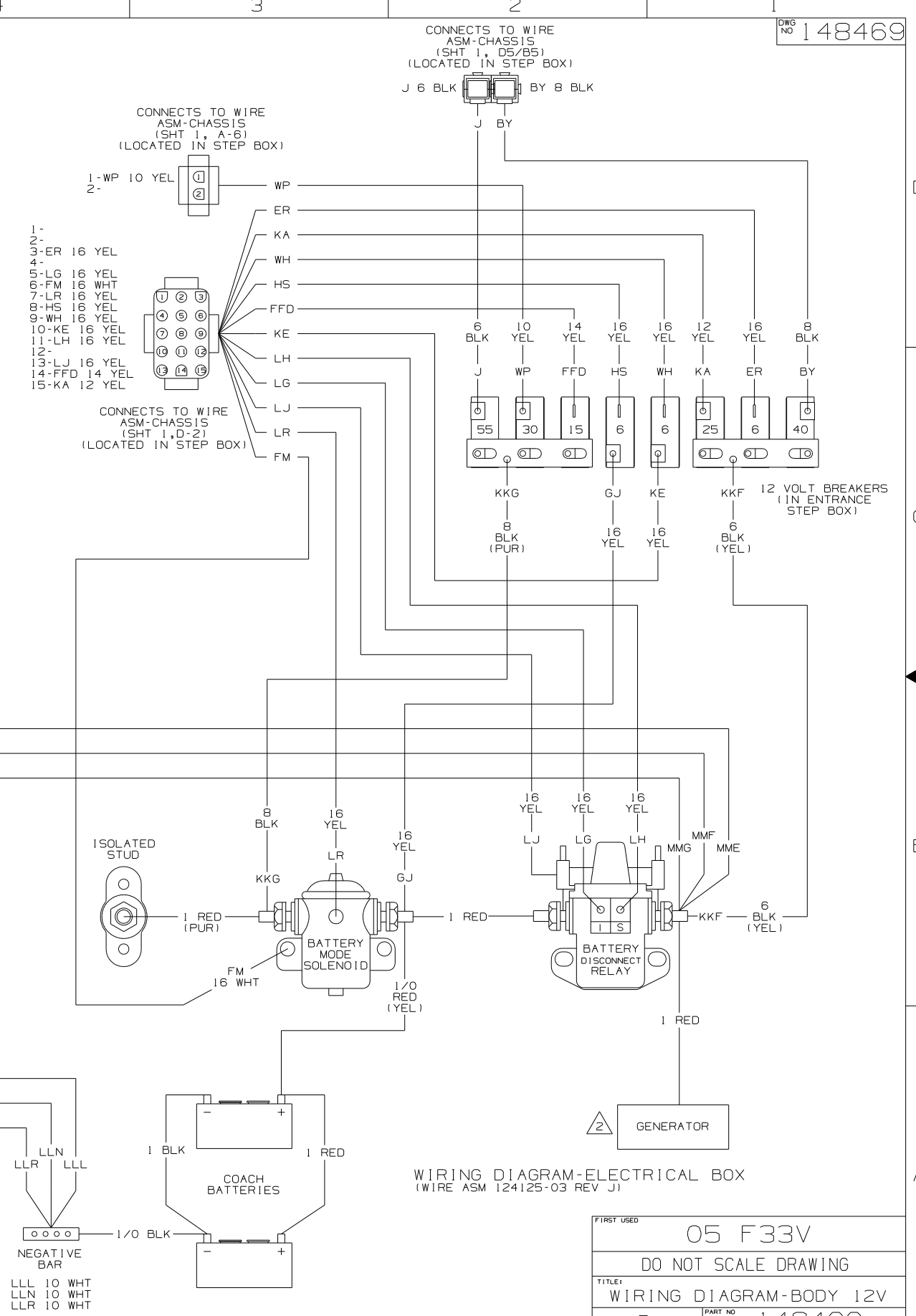
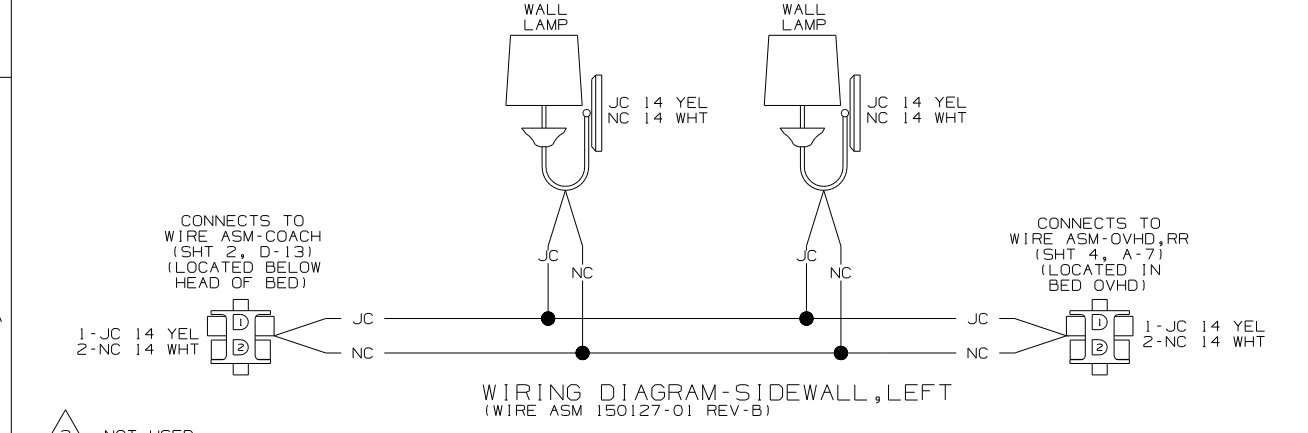
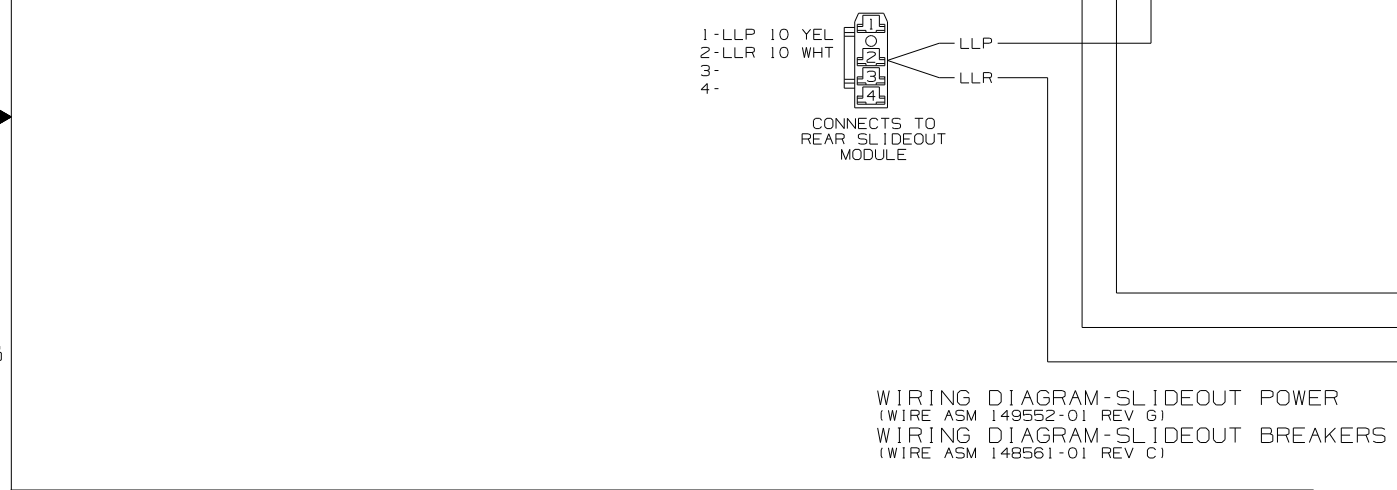
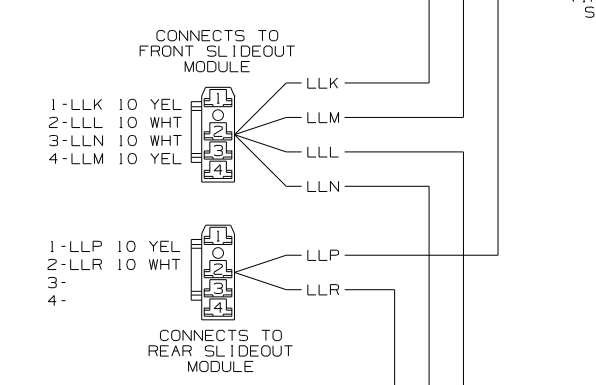
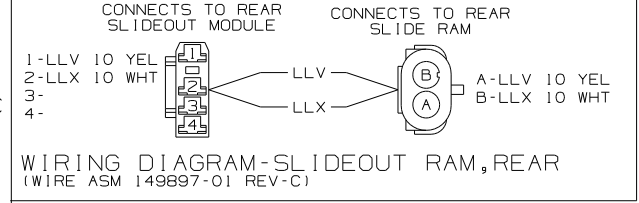
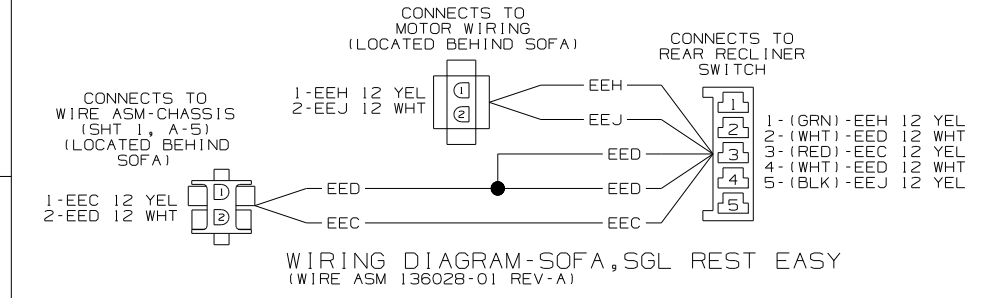
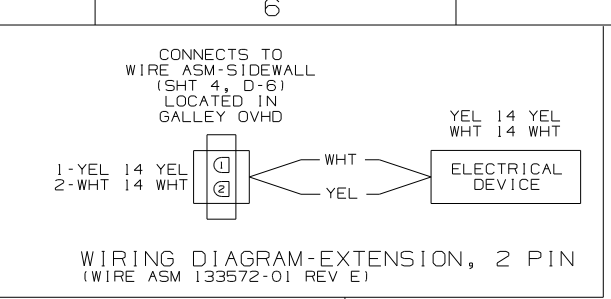
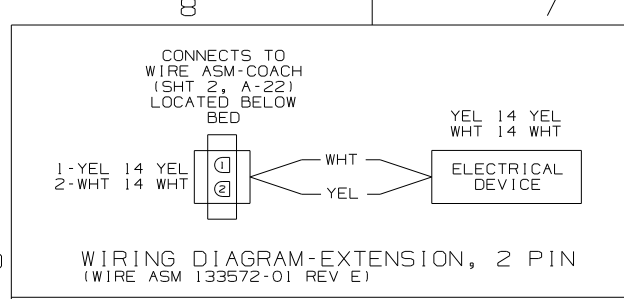
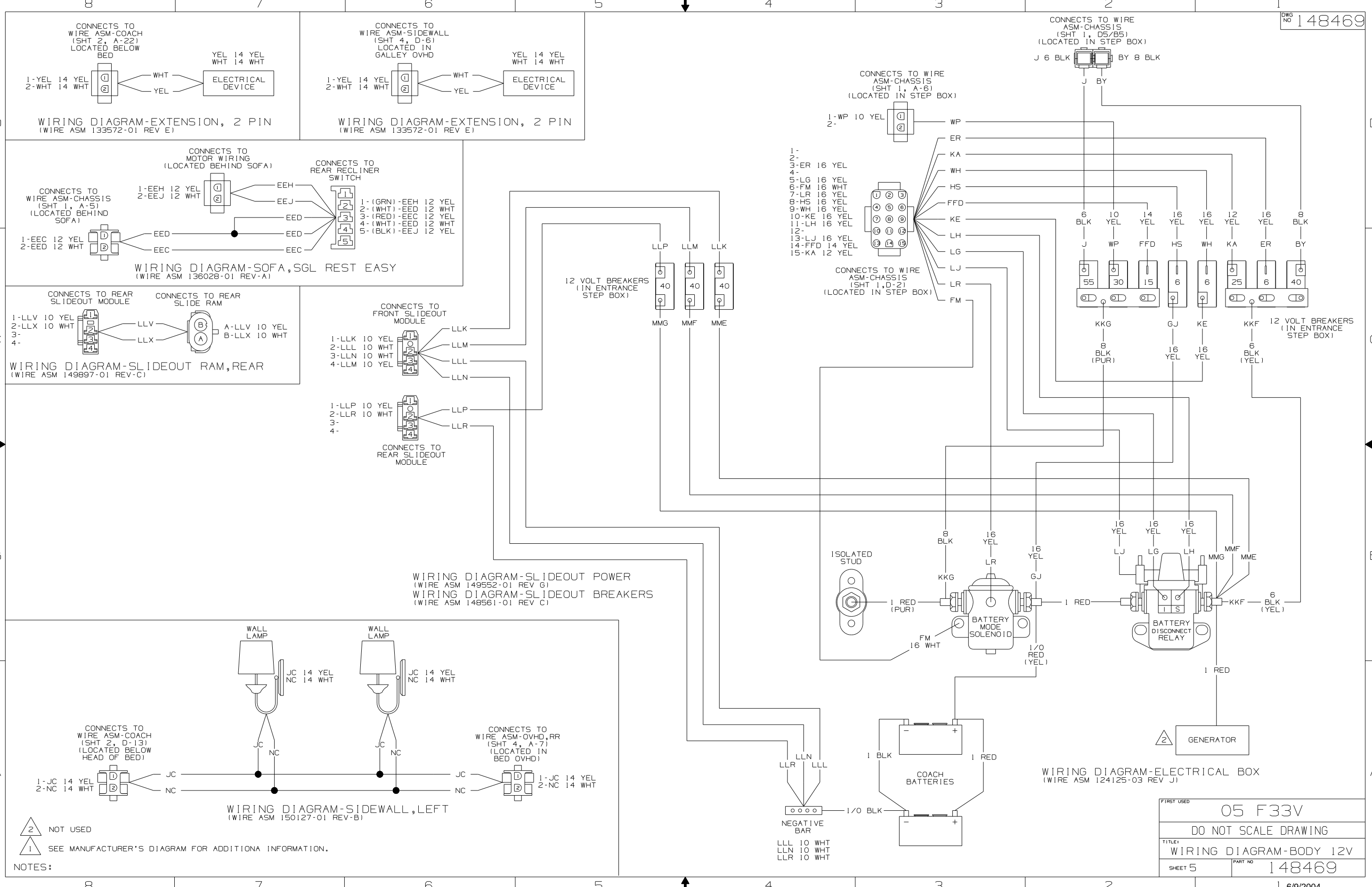

NOTES:

2 NOT USED

1 SEE MANUFACTURER'S DIAGRAM FOR ADDITIONAL INFORMATION.

FIRST USED	05 F33V
TITLE	DO NOT SCALE DRAWING
TITLE	WIRING DIAGRAM-BODY 12V
SHEET 5	PART NO 148469