



DANGER

Danger of electrical shock, burns or death. Always remove all power sources before attempting any repair, service or diagnostic work. Power can be present from shore power, generator, inverter or battery. All power sources must be disabled and secured before performing any service.



CAUTION

If you lack the skills, tools or equipment to perform diagnostic or repair work leave such work to an authorized Winnebago Industries dealer or other qualified shop.

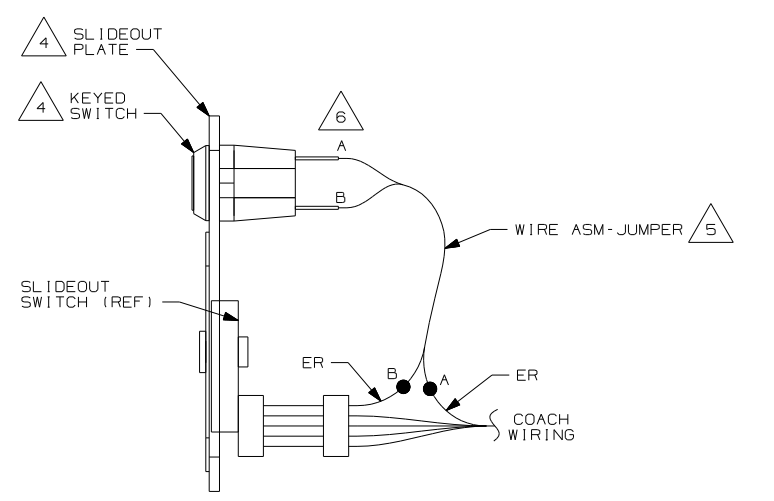
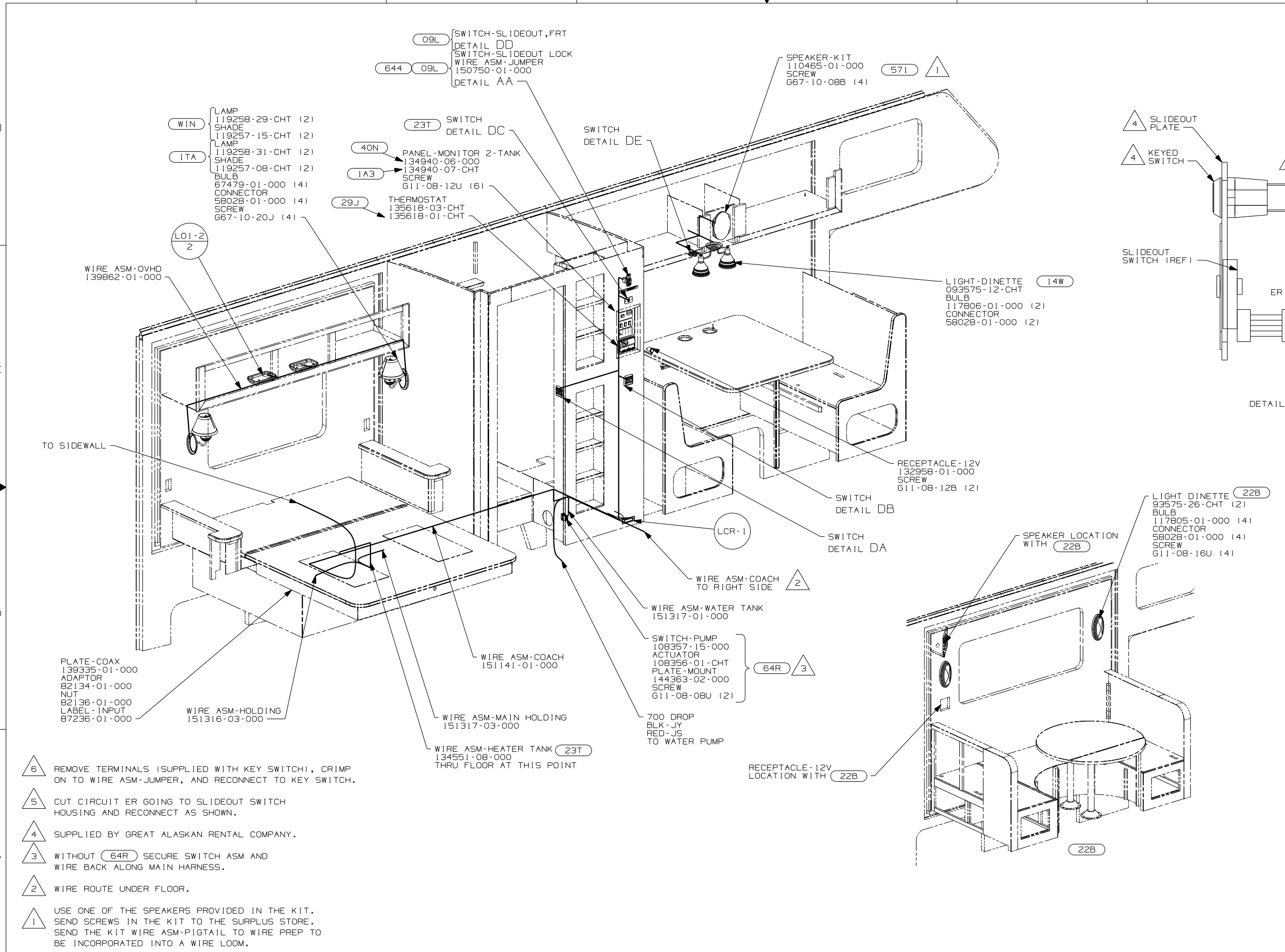

- DETAIL AA (644)
- (644) GREAT ALASKAN RENTAL PACKAGE
 - (09L) SLIDEOUT ROOM FRONT LEFT
 - (64R) EXTERIOR WASH STATION
 - (571) RADIO SPEAKERS
 - (40N) GEN-4.0KW-ONANGAS-MICROQUIET
 - (29J) AC HEAT PUMP-1
 - (23T) DRAINAGE SYSTEM-HEATED
 - (22B) DINETTE - U-SHAPED
 - (14W) DINETTE
 - (1A3) GENERATOR WITHOUT
 - (ITA) ITASCA ONLY
 - (WIN) WINNEBAGO ONLY
 - (265) CODES/STANDARDS-CSA/CMVSS
 - (1B1) CODES/STANDARDS USA

- (6) REMOVE TERMINALS (SUPPLIED WITH KEY SWITCH), CRIMP ON TO WIRE ASM-JUMPER, AND RECONNECT TO KEY SWITCH.
- (5) CUT CIRCUIT ER GOING TO SLIDEOUT SWITCH HOUSING AND RECONNECT AS SHOWN.
- (4) SUPPLIED BY GREAT ALASKAN RENTAL COMPANY.
- (3) WITHOUT (64R) SECURE SWITCH ASM AND WIRE BACK ALONG MAIN HARNESS.
- (2) WIRE ROUTE UNDER FLOOR.
- (1) USE ONE OF THE SPEAKERS PROVIDED IN THE KIT. SEND SCREWS IN THE KIT TO THE SURPLUS STORE. SEND THE KIT WIRE ASM-PIGTAIL TO WIRE PREP TO BE INCORPORATED INTO A WIRE LOOM.

WINNEBAGO
COPYRIGHT 2004 WINNEBAGO INDUSTRIES, INC.

UNSPECIFIED TOLERANCES ARE:
WHOLE DIM (X) :
ONE-PLACE (X.X) :
TWO-PLACE (X.XX) :
ANGLE :
THIRD ANGLE PROJECTION

ORIG. DATE :
ALL DIMENSIONS ARE IN MILLIMETERS
FIRST USED :
05 327L

MATERIAL:
: *
: *
: *

DO NOT SCALE DRAWING

TITLE: WIRING INSTL.-BODY, 12V

SHEET 1 of 6 PART NO 151138

REF: 1 3/10/2005

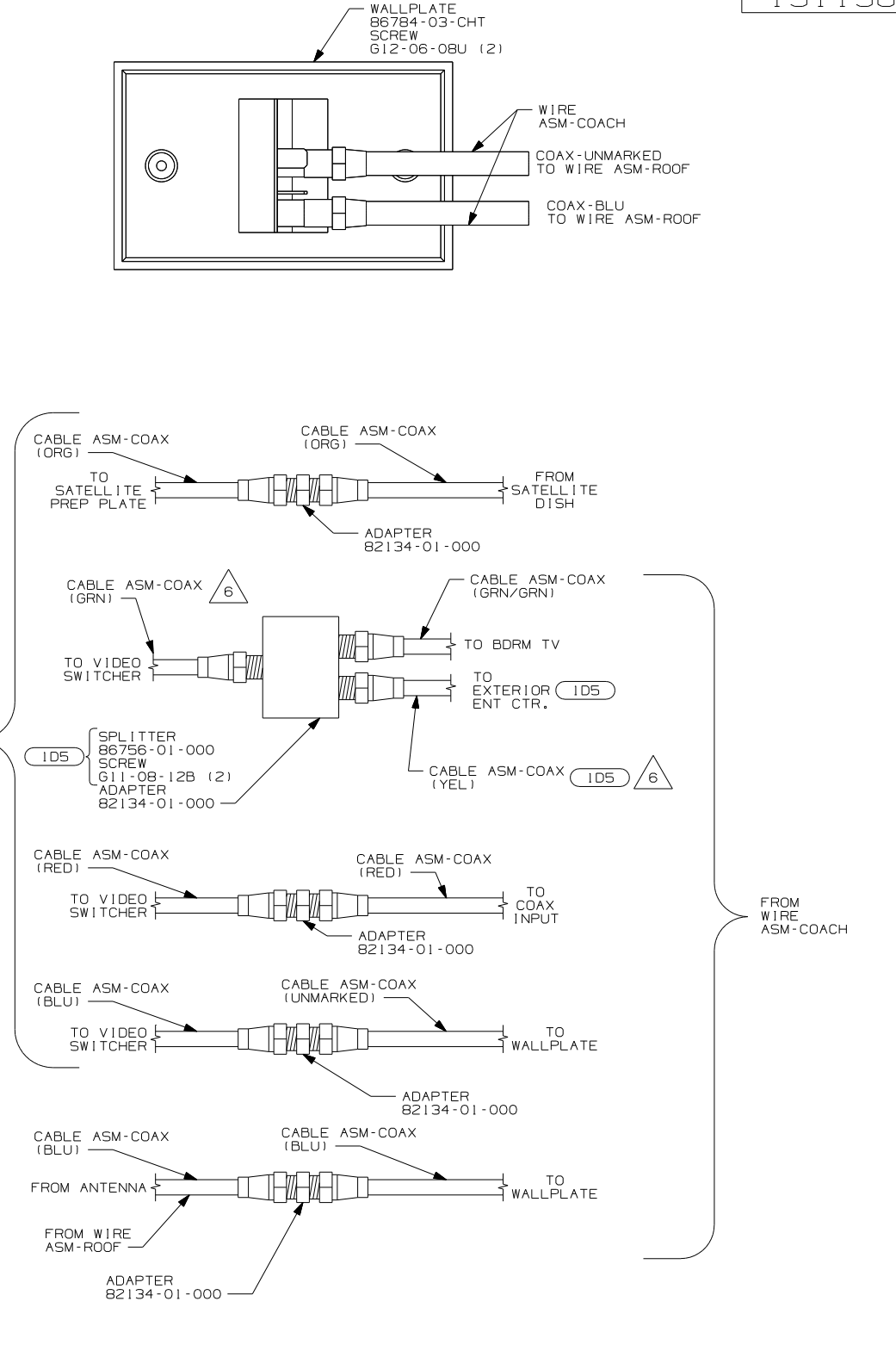
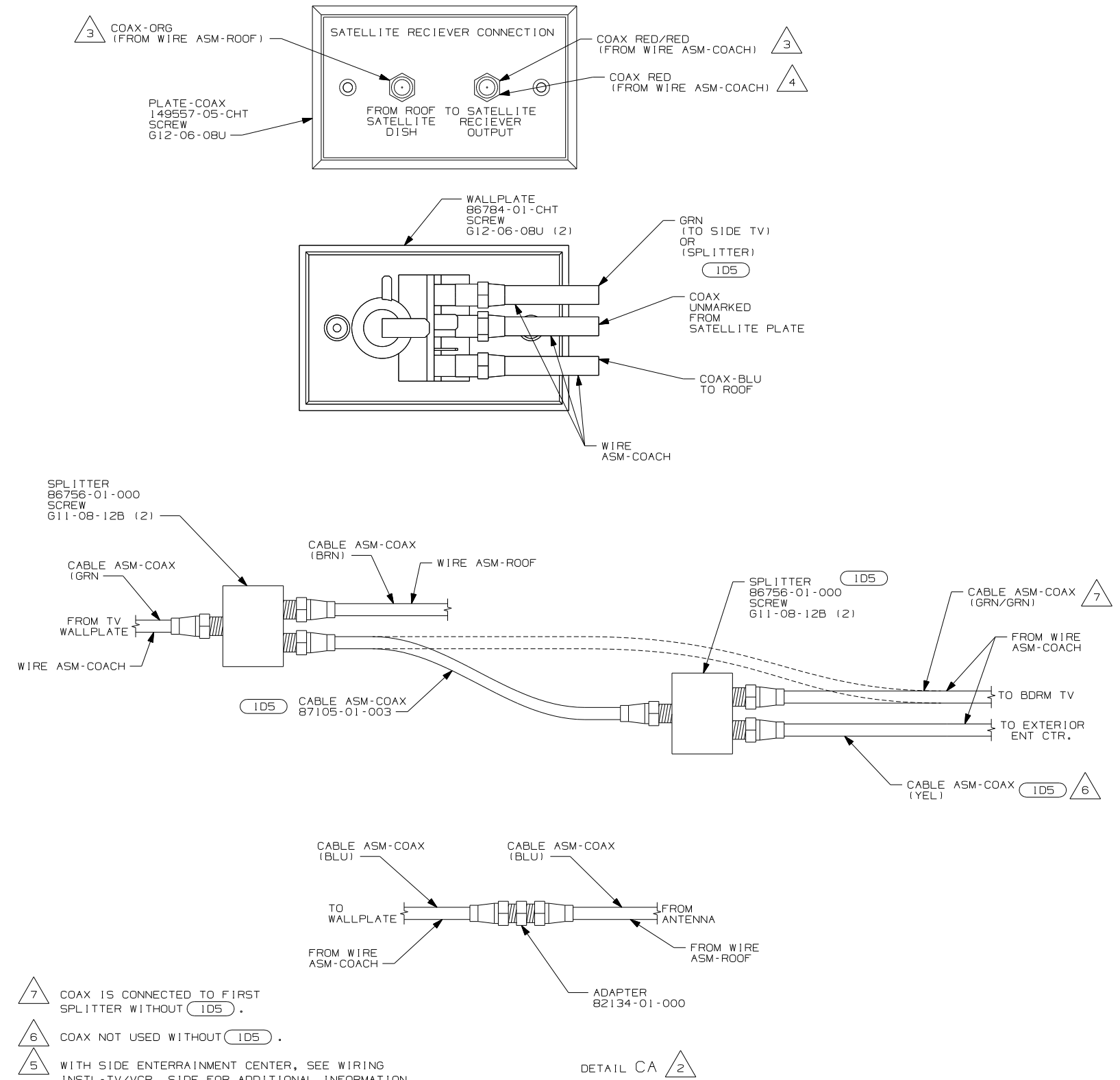

- NOTES:**
- 7 COAX IS CONNECTED TO FIRST SPLITTER WITHOUT (ID5).
 - 6 COAX NOT USED WITHOUT (ID5).
 - 5 WITH SIDE ENTERRAINMENT CENTER, SEE WIRING INSTL-TV/VCR, SIDE FOR ADDITIONAL INFORMATION.
 - 4 CONNECT COAX TO FRONT SIDE OF WALLPLATE.
 - 3 CONNECT COAX TO BACKSIDE OF WALLPLATE.
 - 2 WITHOUT (42J).
 - 1 WITH FRONT ENTERRAINMENT CENTER, SEE WIRING INSTL-TV/VCR, FRONT FOR ADDITIONAL INFORMATION.

- DETAIL CA (42J) (1)**
- (42J) TV-24" COLOR, STEREO W/REMOTE
 - (ID5) ENTERTAINMENT CENTER/EXT W/CD
 - (265) CODES/STANDARDS-CSA/CMVSS
 - (1B1) CODES/STANDARDS USA

FIRST USED	05 327L
DO NOT SCALE DRAWING	
TITLE	WIRING INSTL.-BODY, 12V
SHEET 3	PART NO 151138

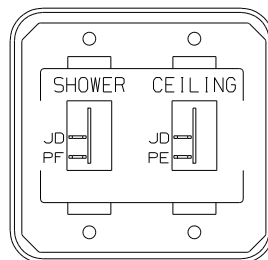

DETAIL DA

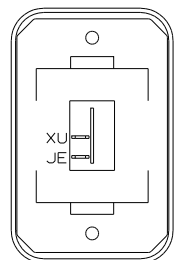

DETAIL DE 14W

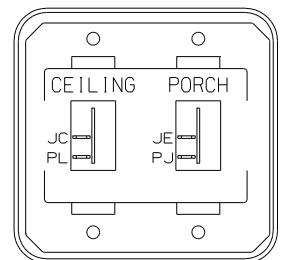

DETAIL DJ

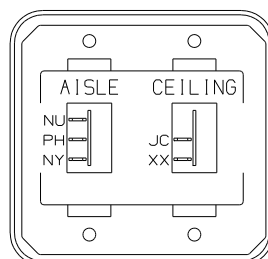

DETAIL DB

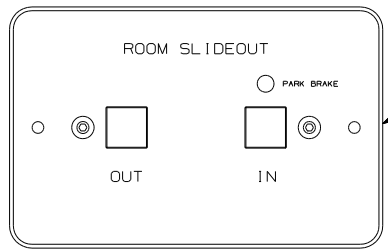

DETAIL DF 19D

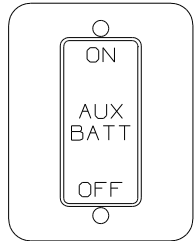
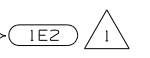
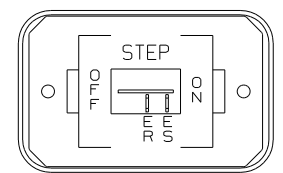

DETAIL DK

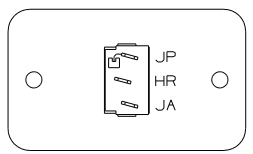

DETAIL DC 23T

HOLDING TANK HEATER
TURN OFF When Not In Use
SEE OPERATORS MANUAL

WARNING UNDERSTAND OPERATOR'S MANUAL BEFORE USING
KEEP PEOPLE AND OBSTRUCTIONS CLEAR OF
SLIDEOUT ROOM WHEN OPERATING TO AVOID
INJURY AND/OR PROPERTY DAMAGE

LABEL-WARNING 116549-01-000

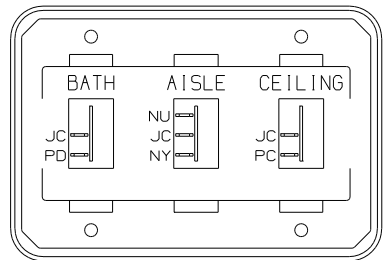

DETAIL DG

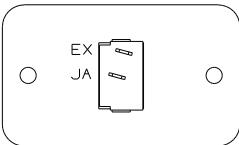

DETAIL DH 1JR

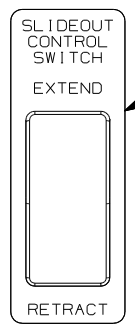

DETAIL DD 09L

WARNING UNDERSTAND OPERATOR'S MANUAL BEFORE USING
KEEP PEOPLE AND OBSTRUCTIONS CLEAR OF
SLIDEOUT ROOM WHEN OPERATING TO AVOID
INJURY AND/OR PROPERTY DAMAGE

LABEL-WARNING 116549-01-000

- 23T DRAINAGE SYSTEM-HEATED
- 19D SLIDEOUT ROOM REAR LEFTHAND
- 14W DINETTE
- 1JR TV-13" W/DVD-12V
- IE2 ENTRANCE STEP-ELEC.
- 09L SLIDEOUT ROOM FRONT LEFT
- 265 CODES/STANDARDS-CSA/CMVSS
- 1B1 CODES/STANDARDS USA

1B1 265

FIRST USED	05 327L
TITLE	DO NOT SCALE DRAWING
	WIRING INSTL.-BODY, 12V
SHEET 4	PART NO 151138

NOTES:
1 CIRCUITS PART OF WIRE ASM-CHASSIS.

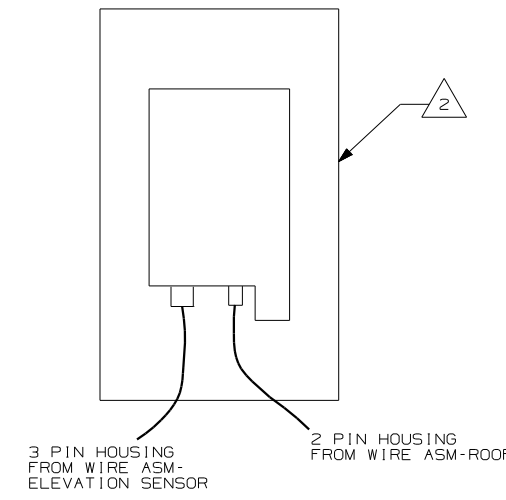

DETAIL EA (480)

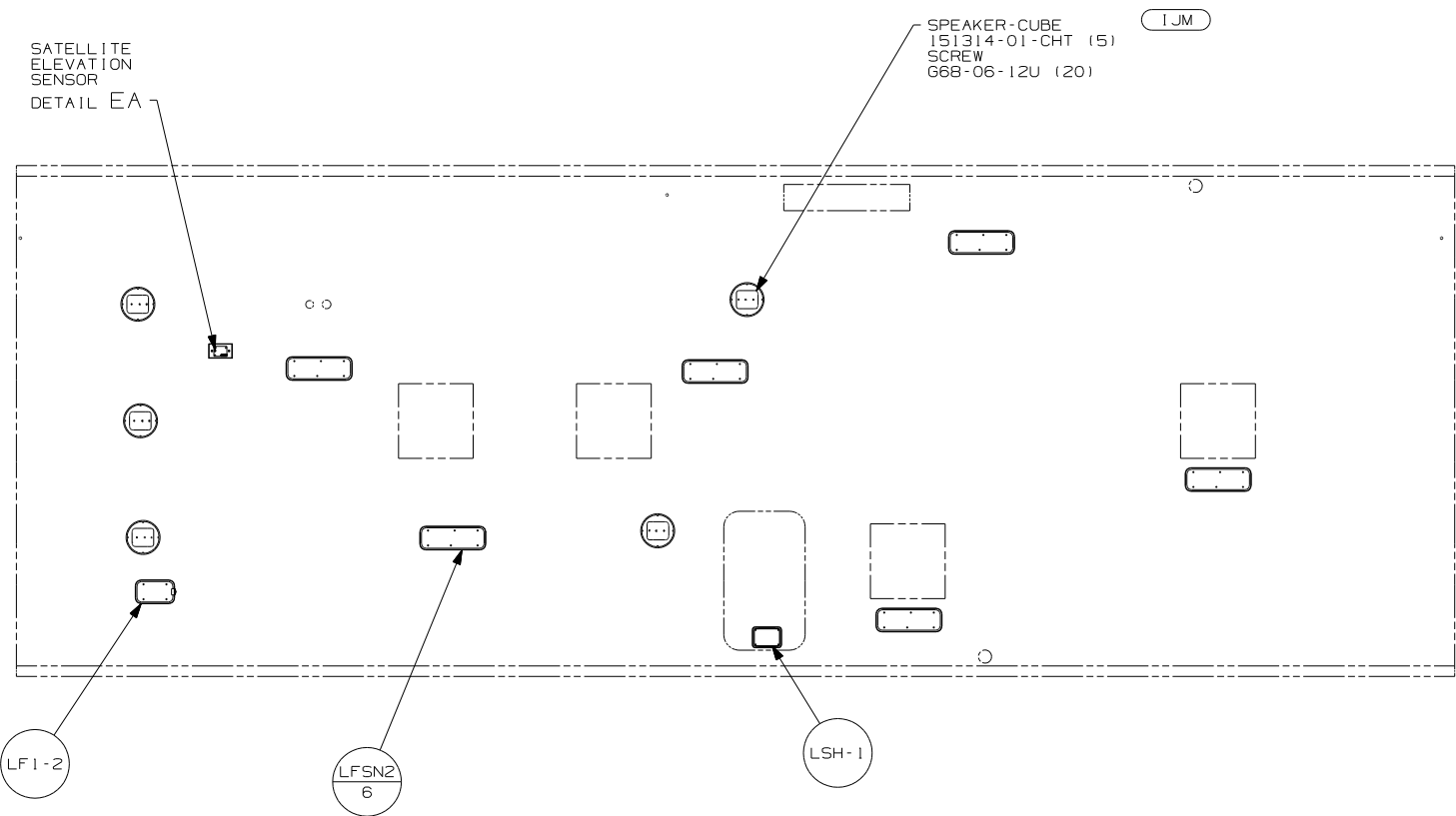

SATELLITE ELEVATION SENSOR
DETAIL EA

SPEAKER-CUBE
151314-01-CHT (5)
SCREW
668-06-12U (20)
(1JM)

(3)

LF1-2

LFSN2
6

LSH-1

- (3) NOT USED WITH (42J).
- (2) SENSOR SUPPLIED WITH SATELLITE ASSEMBLY.

1. SEE ROOF ASM FOR ADDITIONAL INFORMATION.

NOTES:

- (480) SATELLITE DISH & ELEVATION SENSOR.
- (42J) TV-24" COLOR, STEREO W/REMOTE
- (1JM) HOME THEATER SOUND SYSTEM
- (265) CODES/STANDARDS-CSA/CMVSS
- (1B1) CODES/STANDARDS USA

FIRST USED		05 327L	
DO NOT SCALE DRAWING			
TITLE: WIRING INSTL.-BODY, 12V			
SHEET 5	PART NO	151138	

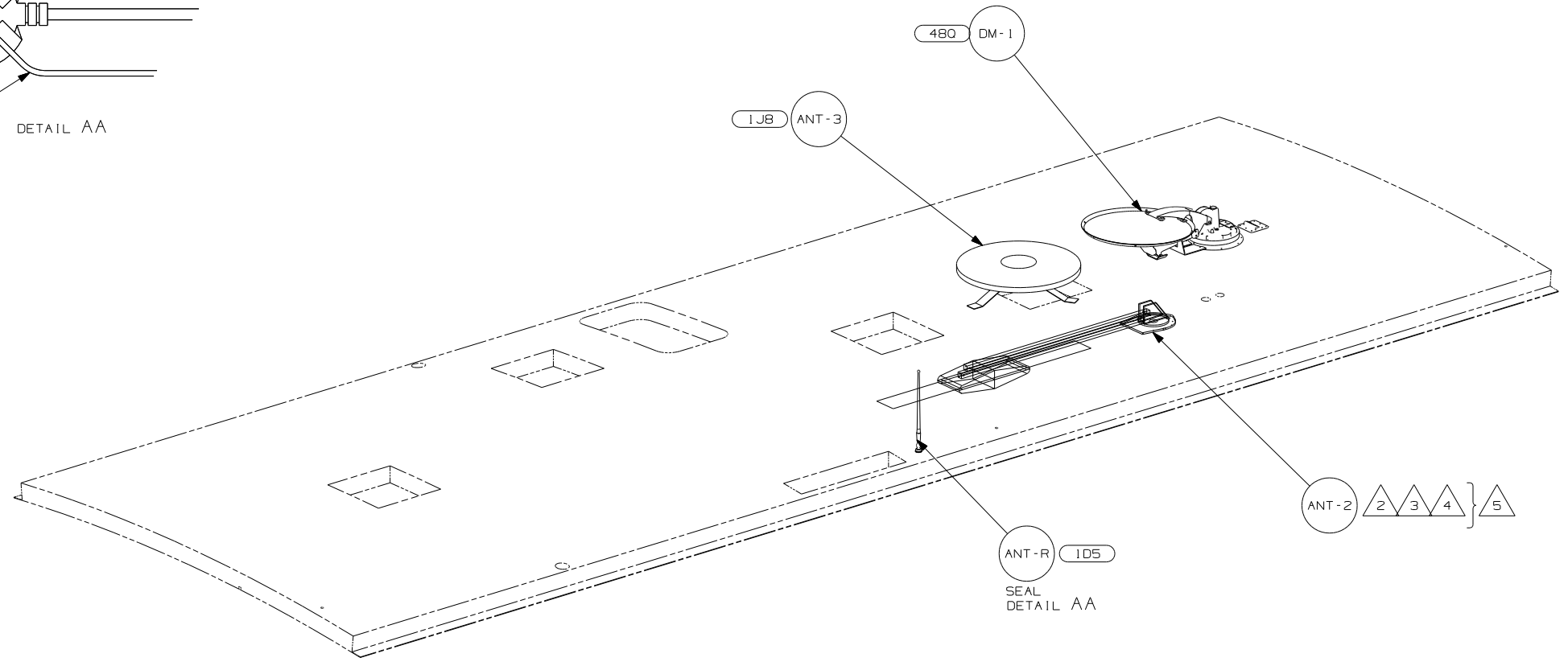
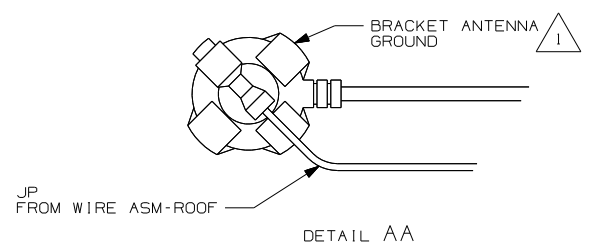

- NOTES:
- 5 NOT USED WITH 1JB.
 - 4 ADD RUBBER BUMPERS TO ROOF UNDER EACH END OF ANTENNA IN DOWN POSITION.
 - 3 LOCATE CLIP TO RETAIN CABLE BUT NOT TO RESTRICT ANTENNA.
 - 2 SEE DRAWING 76319-01-000 FOR INSTALLATION OF TV ANTENNA.
 - 1 WRAP BRACKET LEGS AROUND ANTENNA BASE.

- 480 SATELLITE DISH & ELEV.SENSOR
- 1JB TV ANTENNA-OMNIDIRECTIONAL
- 1D5 ENTERTAINMENT CENTR/EXT W/CD
- 265 CODES/STANDARDS-CSA/CMVSS
- 1B1 CODES/STANDARDS USA

FIRST USED		05 327L	
DO NOT SCALE DRAWING			
TITLE: WIRING INSTL.-BODY,12V			
SHEET 6	PART NO	151138	