



**DANGER**

**Danger of electrical shock, burns or death.** Always remove all power sources before attempting any repair, service or diagnostic work. Power can be present from shore power, generator, inverter or battery. All power sources must be disabled and secured before performing any service.



**CAUTION**

If you lack the skills, tools or equipment to perform diagnostic or repair work leave such work to an authorized Winnebago Industries dealer or other qualified shop.

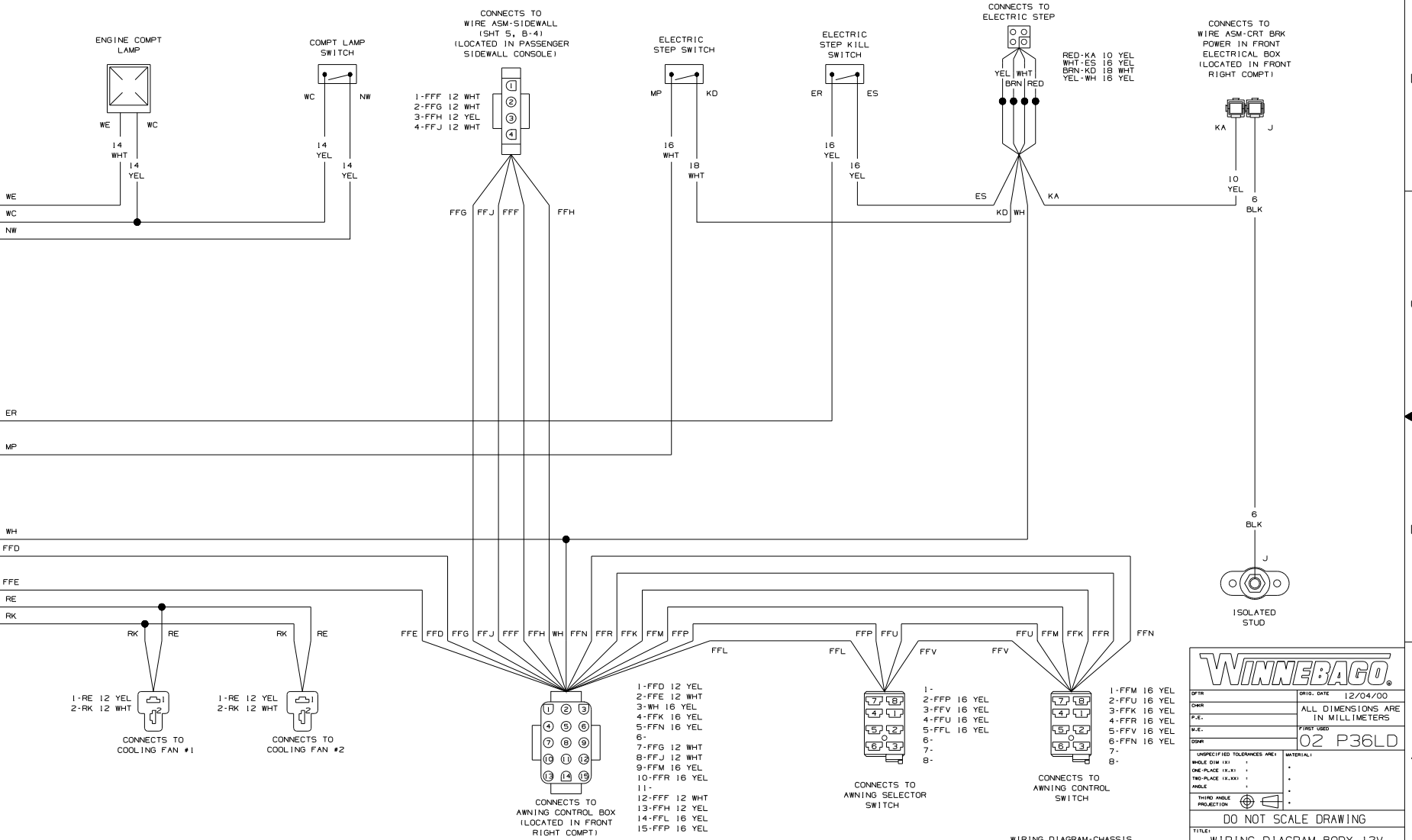

SIF1

WIRING DIAGRAM-CHASSIS  
 WIRE ASM 137992

**WINNEBAGO**

DTR: \_\_\_\_\_ DATE: 12/04/00  
 DWR: \_\_\_\_\_ ALL DIMENSIONS ARE IN MILLIMETERS  
 P.E.: \_\_\_\_\_  
 S.E.: \_\_\_\_\_ FIRST USED: \_\_\_\_\_  
 DSW: \_\_\_\_\_ 02 P36LD

UNSPECIFIED TOLERANCES ARE:  
 HOLE DIA 100: \_\_\_\_\_ MATERIAL: \_\_\_\_\_  
 ONE-PLACE 15.00: \_\_\_\_\_  
 TWO-PLACE 15.00: \_\_\_\_\_  
 ANGLE: \_\_\_\_\_

THIRD ANGLE PROJECTION

DO NOT SCALE DRAWING

TITLE: WIRING DIAGRAM-BODY, 12V  
 SHEET 1 OF 8 PART NO: 137995

REF: 1 PAGE 134

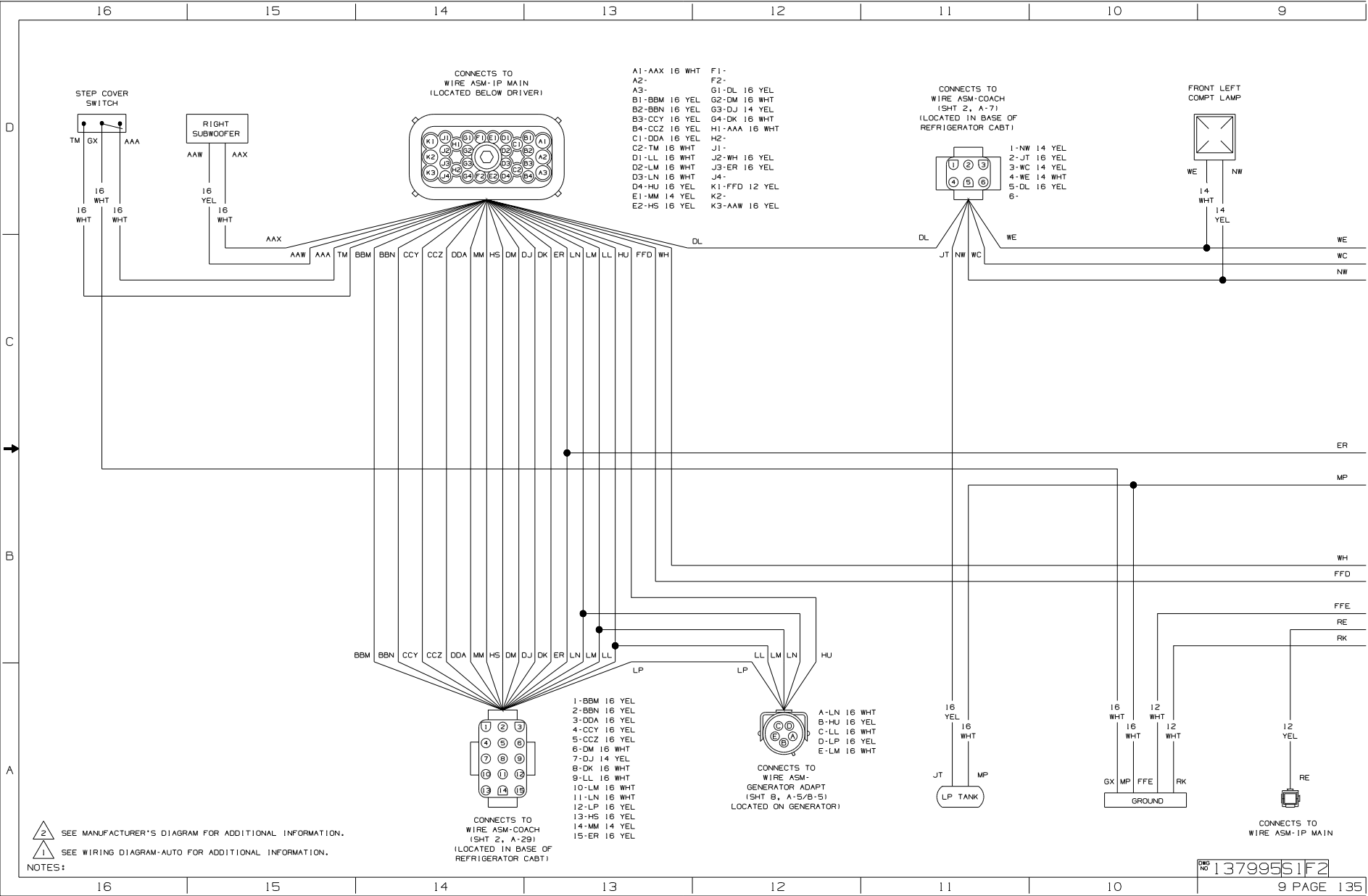

STEP COVER SWITCH

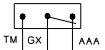

RIGHT SUBWOOFER

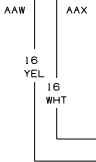

CONNECTS TO WIRE ASM-IP MAIN (LOCATED BELOW DRIVER)

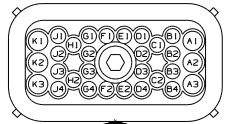

- A1-AAX 16 WHT
- A2-
- A3-
- B1-BBM 16 YEL
- B2-BBN 16 YEL
- B3-CCY 16 YEL
- B4-CCZ 16 YEL
- C1-DDA 16 YEL
- C2-TM 16 WHT
- D1-LL 16 WHT
- D2-LM 16 WHT
- D3-LN 16 WHT
- D4-HU 16 YEL
- E1-MM 14 YEL
- E2-HS 16 YEL
- F1-
- F2-
- G1-DL 16 YEL
- G2-DM 16 WHT
- G3-DJ 14 YEL
- G4-DK 16 WHT
- H1-AAA 16 WHT
- H2-
- J1-
- J2-WH 16 YEL
- J3-ER 16 YEL
- J4-
- K1-FFD 12 YEL
- K2-
- K3-AAW 16 YEL

CONNECTS TO WIRE ASM-COACH (SHT 2, A-7) (LOCATED IN BASE OF REFRIGERATOR CABT)



- 1-NW 14 YEL
- 2-JT 16 YEL
- 3-WC 14 YEL
- 4-WE 14 WHT
- 5-DL 16 YEL
- 6-

FRONT LEFT COMPT LAMP



NOTES:  
 2 SEE MANUFACTURER'S DIAGRAM FOR ADDITIONAL INFORMATION.  
 1 SEE WIRING DIAGRAM-AUTO FOR ADDITIONAL INFORMATION.

CONNECTS TO WIRE ASM-COACH (SHT 2, A-29) (LOCATED IN BASE OF REFRIGERATOR CABT)

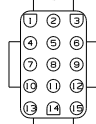

- 1-BBM 16 YEL
- 2-BBN 16 YEL
- 3-DDA 16 YEL
- 4-CCY 16 YEL
- 5-CCZ 16 YEL
- 6-DM 16 WHT
- 7-DJ 14 YEL
- 8-DK 16 WHT
- 9-LL 16 WHT
- 10-LM 16 WHT
- 11-LN 16 WHT
- 12-LP 16 YEL
- 13-HS 16 YEL
- 14-MM 14 YEL
- 15-ER 16 YEL

CONNECTS TO WIRE ASM-GENERATOR ADAPT (SHT 8, A-5/8-5) (LOCATED ON GENERATOR)



- A-LN 16 WHT
- B-HU 16 YEL
- C-LL 16 WHT
- D-LP 16 YEL
- E-LM 16 WHT

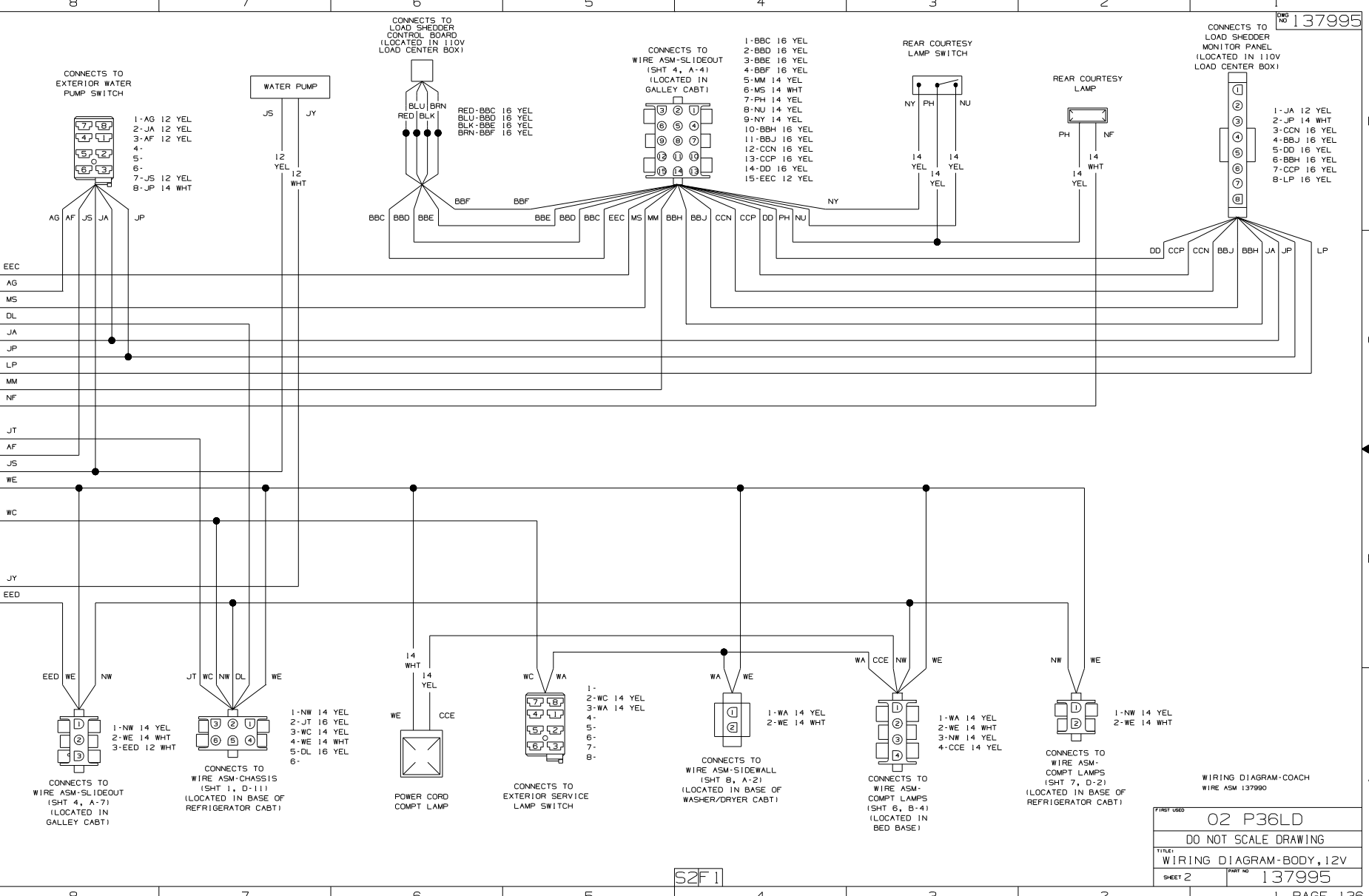

CONNECTS TO  
LOAD SHEDDER  
CONTROL BOARD  
(LOCATED IN 110V  
LOAD CENTER BOX)

CONNECTS TO  
WIRE ASM-SLIDEOUT  
(SHT 4, A-4)  
(LOCATED IN  
GALLEY CABT)

REAR COURTESY  
LAMP SWITCH

CONNECTS TO  
LOAD SHEDDER  
MONITOR PANEL  
(LOCATED IN 110V  
LOAD CENTER BOX)

CONNECTS TO  
EXTERIOR WATER  
PUMP SWITCH

WATER PUMP

- 1-AG 12 YEL
- 2-JA 12 YEL
- 3-AF 12 YEL
- 4.
- 5.
- 6.
- 7-JS 12 YEL
- 8-JP 14 WHT

- RED-BBC 16 YEL
- BLU-BBD 16 YEL
- BLK-BBE 16 YEL
- BRN-BBF 16 YEL

- 1-BBC 16 YEL
- 2-BBD 16 YEL
- 3-BBE 16 YEL
- 4-BBF 16 YEL
- 5-MM 14 YEL
- 6-MS 14 WHT
- 7-PH 14 YEL
- 8-NU 14 YEL
- 9-NY 14 YEL
- 10-BBH 16 YEL
- 11-BBJ 16 YEL
- 12-CCN 16 YEL
- 13-CCP 16 YEL
- 14-DD 16 YEL
- 15-EEC 12 YEL

- 1-JA 12 YEL
- 2-JP 14 WHT
- 3-CCN 16 YEL
- 4-BBJ 16 YEL
- 5-DD 16 YEL
- 6-BBH 16 YEL
- 7-CCP 16 YEL
- 8-LP 16 YEL

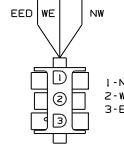
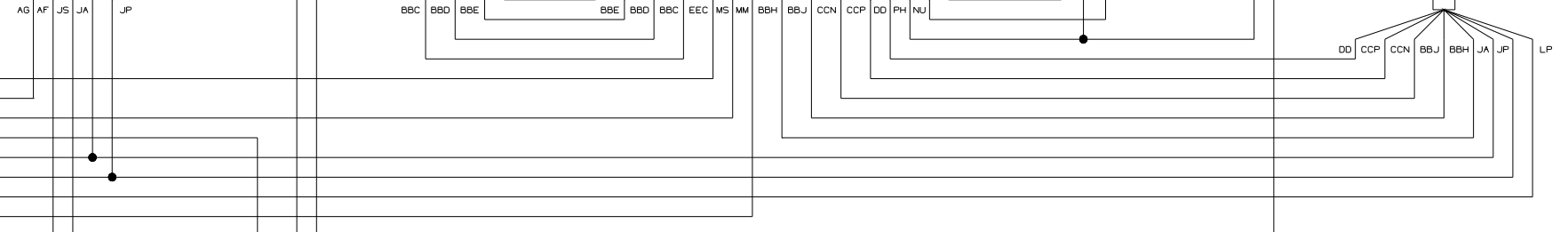

CONNECTS TO  
WIRE ASM-SLIDEOUT  
(SHT 4, A-7)  
(LOCATED IN  
GALLEY CABT)

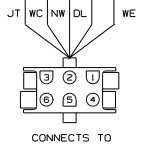

CONNECTS TO  
WIRE ASM-CHASSIS  
(SHT 1, D-11)  
(LOCATED IN BASE OF  
REFRIGERATOR CABT)

- 1-NW 14 YEL
- 2-JT 16 YEL
- 3-WC 14 YEL
- 4-WE 14 WHT
- 5-DL 16 YEL
- 6-

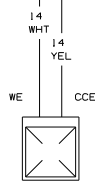

POWER CORD  
COMPT LAMP

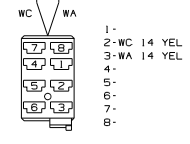

CONNECTS TO  
WIRE ASM-SIDEWALL  
(SHT 8, A-2)  
(LOCATED IN BASE OF  
WASHER/DRYER CABT)

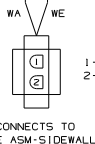

CONNECTS TO  
WIRE ASM-SIDEWALL  
(SHT 8, A-2)  
(LOCATED IN BASE OF  
WASHER/DRYER CABT)

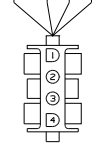

CONNECTS TO  
WIRE ASM-  
COMPT LAMPS  
(SHT 7, D-2)  
(LOCATED IN BASE OF  
REFRIGERATOR CABT)

- 1-WA 14 YEL
- 2-WE 14 WHT
- 3-NW 14 YEL
- 4-CCE 14 YEL

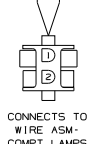

CONNECTS TO  
WIRE ASM-  
COMPT LAMPS  
(SHT 7, D-2)  
(LOCATED IN BASE OF  
REFRIGERATOR CABT)

- 1-NW 14 YEL
- 2-WE 14 WHT

WIRING DIAGRAM-COACH  
WIRE ASM 137990

FIRST USED	02 P36LD
TITLE	DO NOT SCALE DRAWING
WIRING DIAGRAM-BODY, 12V	
SHEET 2	PART NO 137995

S2F1

CONNECTS TO  
WIRE ASM-SIDEWALL,RIGHT  
(SHT 5, D-7)  
(LOCATED IN BASE OF  
REFRIGERATOR CABT)

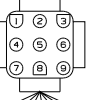

- 1-NM 14 YEL
- 2-PM 14 WHT
- 3-PL 14 YEL
- 4-JG 14 YEL
- 5-JN 14 WHT
- 6-FFX 14 WHT
- 7-FFX 14 YEL
- 8-
- 9-

CONNECTS TO  
WIRE ASM-ROOF  
(SHT 3, A-12)  
(LOCATED BEHIND  
BEDROOM TV)

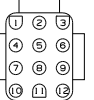

- 1-JA 12 YEL
- 2-JP 14 WHT
- 3-DL 16 YEL
- 4-DM 16 WHT
- 5-JE 14 YEL
- 6-NE 14 WHT
- 7-HS 16 YEL
- 8-HT 16 WHT
- 9-PL 14 YEL
- 10-PM 14 WHT
- 11-A 14 YEL
- 12-JC 14 YEL



ISOLATED STUD  
(LOCATED IN BASE OF  
REFRIGERATOR CABT)

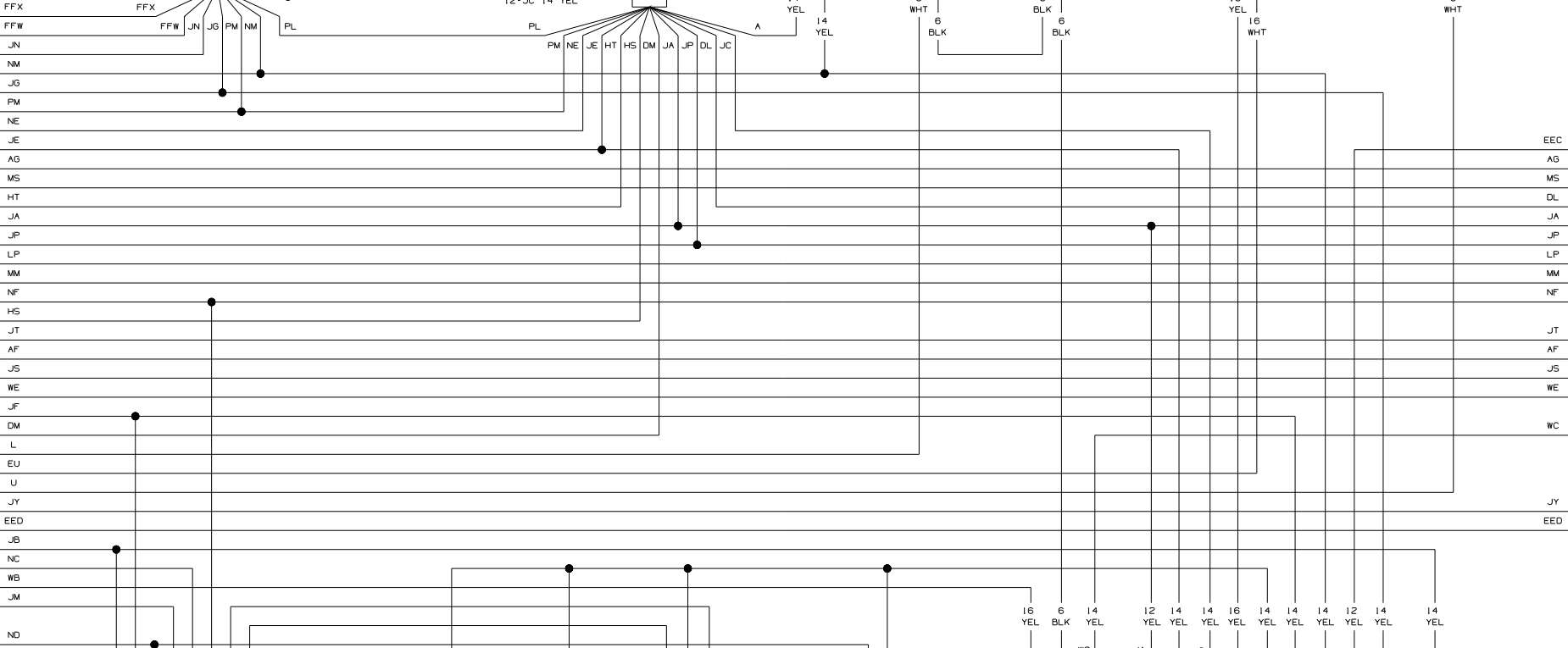

- 1-NC 14 WHT
- 2-PC 14 YEL
- 3-ND 14 WHT
- 4-PF 14 YEL
- 5-NF 14 WHT
- 6-JB 14 YEL
- 7-JM 14 WHT
- 8-JF 14 YEL
- 9-YM 14 YEL
- 10-YN 14 YEL
- 11-
- 12-

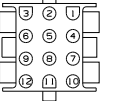

CONNECTS TO  
WIRE ASM-ROOF  
(SHT 3, A-14)  
(LOCATED BEHIND  
BEDROOM TV)

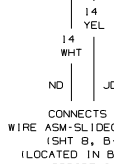
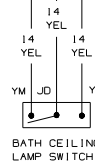
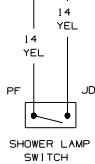
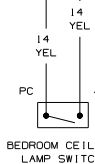

CONNECTS TO  
WIRE ASM-SLIDEOUT,REAR  
(SHT B, B-4)  
(LOCATED IN BASE OF  
WARDROBE CABT)

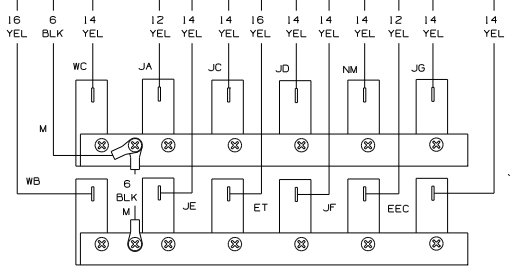

12V BREAKER  
PANEL

CONNECTS TO WIRE  
ASM-EXT ENT CTR  
(SHT 8, C-1/D-1)  
(LOCATED ABOVE  
EXT ENT CTR)

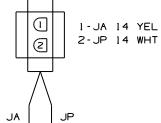

WINTERIZATION  
SWITCH

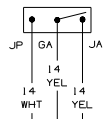

WATER BYPASS  
SWITCH

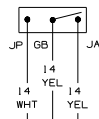

WATER HEATER  
BYPASS VALVE

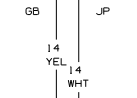

WINTERIZATION  
VALVE

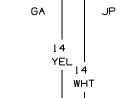

CONNECTS TO  
SIDEWALL, RR  
(SHT 7, C-4)  
(LOCATED IN BASE  
OF LAVATORY CABT)

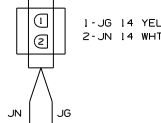

LOUNGE CEILING  
LAMP SWITCH

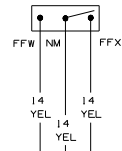

AG  
HT  
JA  
JP  
LP  
MM  
NF  
HS  
JT  
AF  
JS  
GL  
JF  
DM  
L  
EU  
U  
JY  
EED  
JB  
NC  
WB  
JM  
JJ  
JX

FFW  
FFW  
JN  
NM  
JG  
PM  
NE  
JE  
AG  
MS  
HT  
JA  
JP  
LP  
MM  
NF  
HS  
JT  
AF  
JS  
WE  
DM  
L  
EU  
U  
JY  
EED  
JB  
NC  
WB  
JM  
JJ  
ND

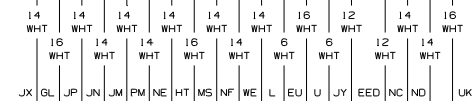
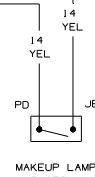
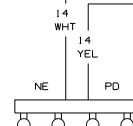
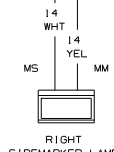

(LOCATED IN POWERCORD COMPT)

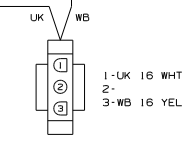

CONNECTS TO LP DETECTOR

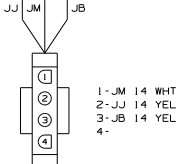

CONNECTS TO FURNACE

D  
C  
B  
A

(SHT 5, B-6)  
(LOCATED IN BASE OF REFRIGERATOR CABT)

WIRE ASM-SIDEWALL RIGHT

H

H

WIRE ASM-SIDEWALL,RR

(SHT 7, A-3)  
(LOCATED IN BASE OF LAVATORY CABT)

CABLE INPUT

E

E

WIRE ASM-SIDEWALL,RR

(SHT 7, A-3)  
(LOCATED IN BASE OF LAVATORY CABT)



CONNECTS TO WIRE ASM-SLIDEOUT (SHT 4, D-11) (LOCATED IN GALLEY CABT)

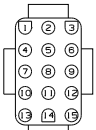

- 1-JF 14 YEL
- 2-NF 14 WHT
- 3-DJ 16 YEL
- 4-DK 16 WHT
- 5-LP 16 YEL
- 6-LL 16 WHT
- 7-LM 16 WHT
- 8-LN 16 WHT
- 9-JA 14 YEL
- 10-ER 16 YEL
- 11-JP 14 WHT
- 12-XH 16 YEL
- 13-XJ 16 YEL
- 14-XK 16 YEL
- 15-AG 12 YEL

CONNECTS TO WIRE ASM-WATER TANK (LOCATED BELOW SHOWER)



- 1-XH 16 YEL
- 2-GL 16 WHT

CONNECTS TO WIRE ASM-AUX HOLDING (LOCATED BELOW SHOWER)



- 1-XK 16 YEL
- 2-GL 16 WHT

CONNECTS TO WIRE ASM-MAIN HOLDING TANK (LOCATED BELOW SHOWER)



- 1-XJ 16 YEL
- 2-GL 16 WHT

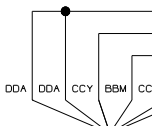

CONNECTS TO REAR SLIDEOUT SWITCH

- 1-DDA 16 YEL
- 2-CCY 16 YEL
- 3-DDA 16 YEL
- 4-BBM 16 YEL
- 5-CCZ 16 YEL
- 6-BBN 16 YEL
- 7-
- 8-

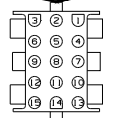

CONNECTS TO WIRE ASM-CHASSIS (SHT 1, A-14) (LOCATED IN BASE OF REFRIGERATOR CABT)

- 1-BBM 16 YEL
- 2-BBN 16 YEL
- 3-DDA 16 YEL
- 4-CCY 16 YEL
- 5-CCZ 16 YEL
- 6-DM 16 WHT
- 7-DJ 16 YEL
- 8-DK 16 WHT
- 9-LL 16 WHT
- 10-LM 16 WHT
- 11-LN 16 WHT
- 12-LP 16 YEL
- 13-HS 16 YEL
- 14-MM 14 YEL
- 15-ER 16 YEL

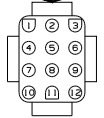

CONNECTS TO WIRE ASM-SLIDEOUT (SHT 4, A-14) (LOCATED IN GALLEY CABT)

- 1-JS 12 YEL
- 2-AF 12 YEL
- 3-JT 16 YEL
- 4-JW 14 YEL
- 5-JU 14 YEL
- 6-HS 16 YEL
- 7-HT 16 WHT
- 8-IHS 16 YEL
- 9-IHT 16 WHT
- 10-JB 14 YEL
- 11-JM 14 WHT
- 12-JJ 14 YEL

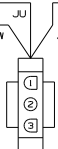

CONNECTS TO WATER HEATER

- 1-JW 14 YEL
- 2-JX 14 WHT
- 3-JU 14 YEL

NOTES:  
1 SEE MANUFACTURER'S DIAGRAM FOR ADDITIONAL INFORMATION.

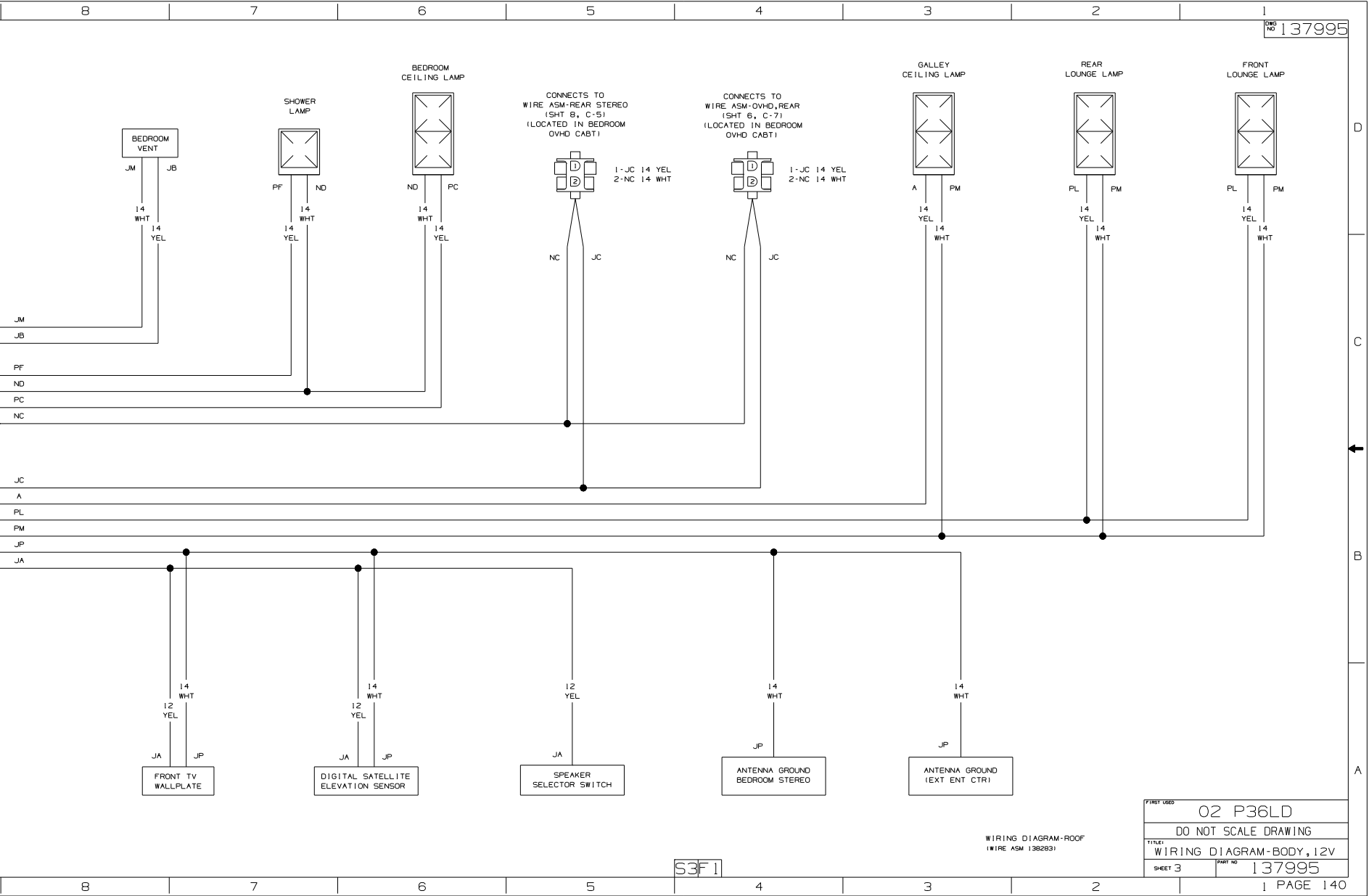

S3F1

WIRING DIAGRAM-ROOF  
1 WIRE ASM 1382531

FIRST USED	02 P36LD
DO NOT SCALE DRAWING	
TITLE: WIRING DIAGRAM-BODY, 12V	
SHEET 3	PART NO 137995



D

C

B

A

CONNECTS TO  
WIRE ASM-BATH WALL  
(SHT 7, C-8)  
(LOCATED IN REAR  
BATH WALL)

- 1-YM 14 YEL
- 2-YN 14 YEL
- 3-WX 14 YEL
- 4-JF 14 YEL
- 5-PE 14 YEL
- 6-JB 14 YEL
- 7-JM 14 WHT
- 8-
- 9-KJ 14 YEL
- 10-KH 14 YEL
- 11-KG 14 YEL
- 12-

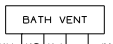
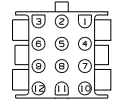

- KH 14 YEL
- KG 14 YEL
- KJ 14 YEL
- JM 14 WHT

BATH CEILING LAMP

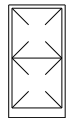

- PE 14 YEL
- NF 14 YEL

HALL CEILING LAMP

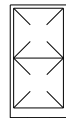

- WX 14 YEL
- ND 14 WHT

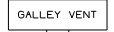

- JM 14 WHT
- JB 14 YEL

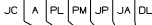
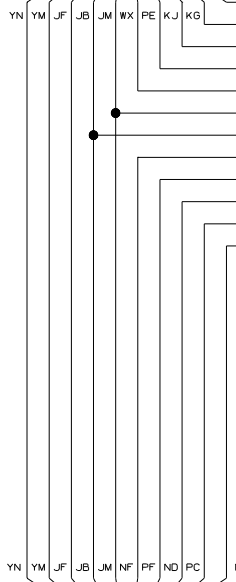
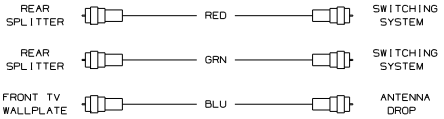

- 1-NC 14 WHT
- 2-PC 14 YEL
- 3-ND 14 WHT
- 4-PF 14 YEL
- 5-NF 14 YEL
- 6-JB 14 YEL
- 7-JM 14 WHT
- 8-JF 14 YEL
- 9-YM 14 YEL
- 10-YN 14 YEL
- 11-
- 12-

CONNECTS TO  
WIRE ASM-COACH  
(SHT 2, A-18)  
(LOCATED BEHIND  
BEDROOM TV)

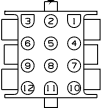

CONNECTS TO  
WIRE ASM-COACH  
(SHT 2, A-13)  
(LOCATED BEHIND  
BEDROOM TV)

- 1-JA 12 YEL
- 2-JP 14 WHT
- 3-DL 16 YEL
- 4-DM 16 WHT
- 5-JE 14 YEL
- 6-NE 14 WHT
- 7-HS 16 YEL
- 8-HT 16 WHT
- 9-PL 14 YEL
- 10-PM 14 WHT
- 11-A 14 YEL
- 12-JC 14 YEL

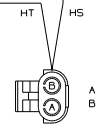

CONNECTS TO  
SOLAR PANEL

- A-HS 16 YEL
- B-HT 16 WHT

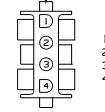

CONNECTS TO  
WIRE ASM-OVHD  
(SHT 6, A-6)  
(LOCATED IN DINETTE  
OVHD CABT)

- 1-DL 16 YEL
- 2-DM 16 WHT
- 3-JE 14 YEL
- 4-NE 14 WHT

JM  
JB  
PF  
ND  
NC  
JC  
A  
PL  
PM  
JP  
JA

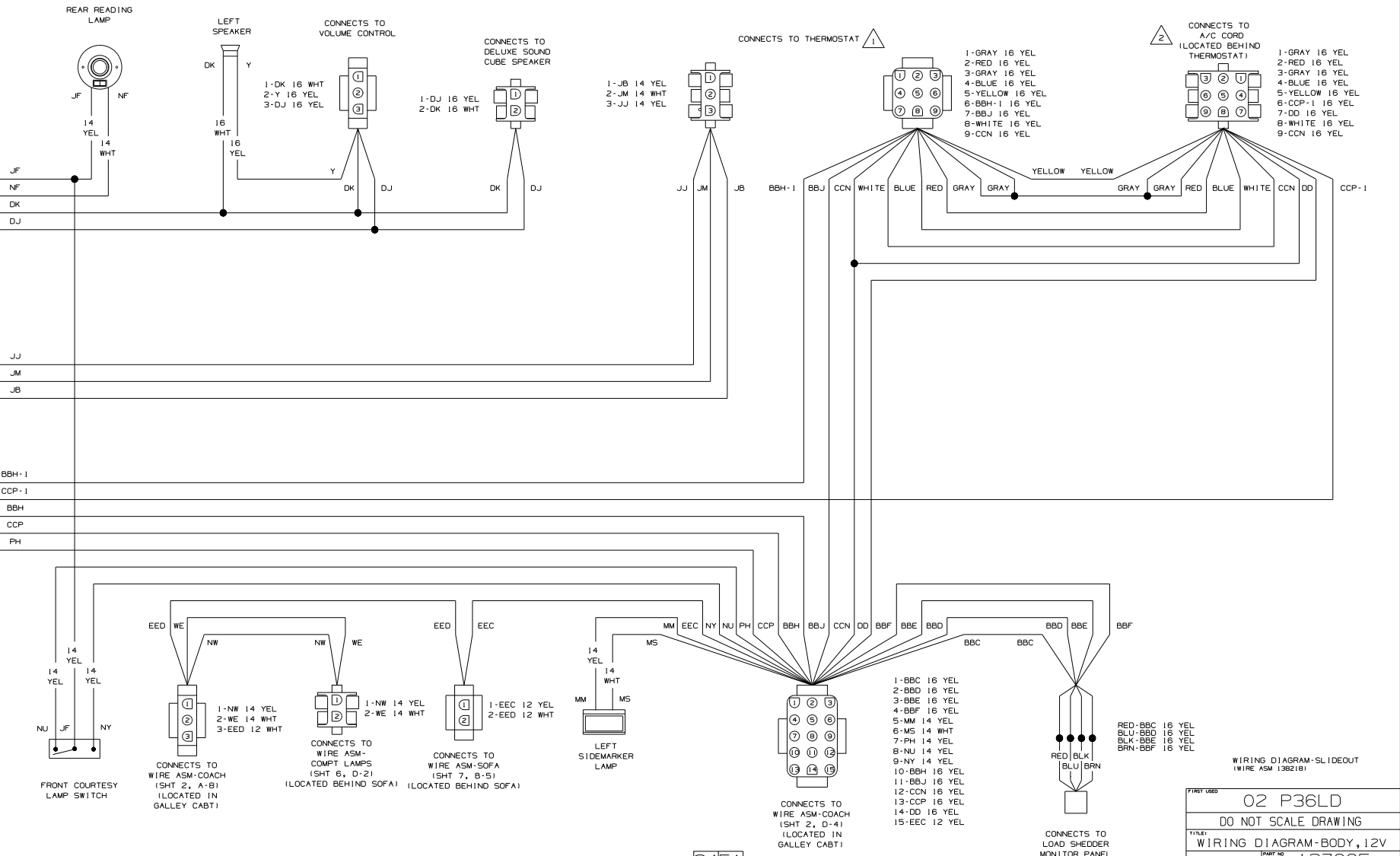

S4F1

FIRST USED		02 P36LD	
DO NOT SCALE DRAWING			
TITLE			
WIRING DIAGRAM-BODY, 12V			
SHEET 4	PART NO	137995	

- 1-JA 14 YEL
- 2-ER 16 YEL
- 3-JP 14 WHT
- 4-XH 16 YEL
- 5-XJ 16 WHT
- 6-XK 16 YEL
- 7-AG 12 YEL
- 8-JS 12 YEL
- 9-AF 12 YEL
- 10-
- 11-JP 14 WHT
- 12-JT 16 YEL
- 13-JW 14 YEL
- 14-
- 15-JU 14 YEL

CONNECTS TO  
MONITOR PANEL 

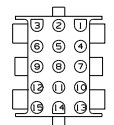

- 1-LP 16 YEL
- 2-LL 16 WHT
- 3-LM 16 WHT
- 4-LN 16 WHT

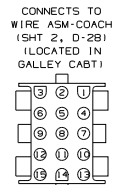

- 1-JF 14 YEL
- 2-NF 14 WHT
- 3-DJ 16 YEL
- 4-DK 16 WHT
- 5-LP 16 YEL
- 6-LL 16 WHT
- 7-LM 16 WHT
- 8-LN 16 WHT
- 9-JA 14 YEL
- 10-ER 16 YEL
- 11-JP 14 WHT
- 12-XH 16 YEL
- 13-XJ 16 WHT
- 14-XK 16 YEL
- 15-AG 12 YEL

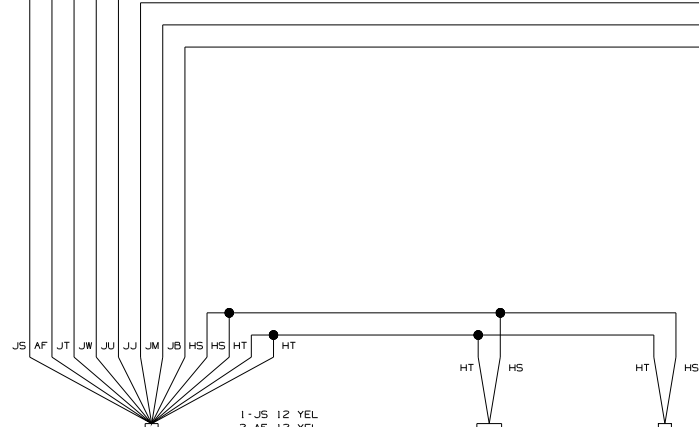
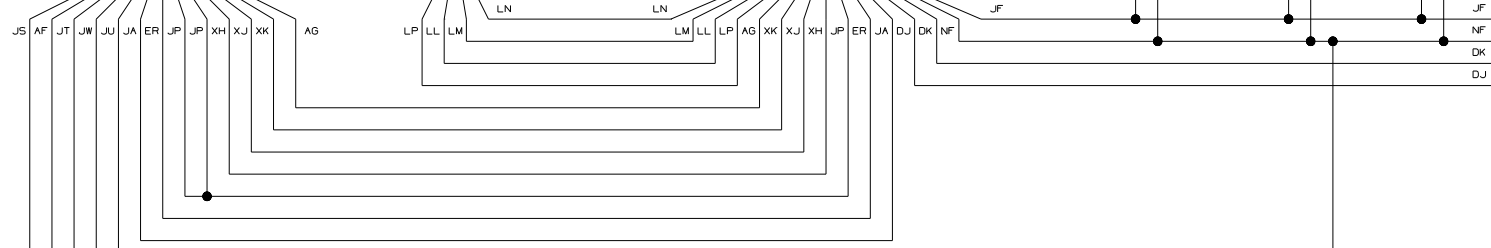
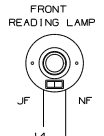
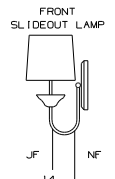
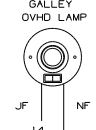

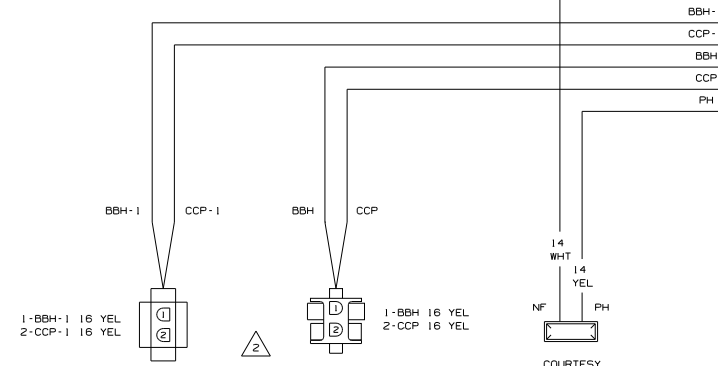

- 1-JS 12 YEL
- 2-AF 12 YEL
- 3-JT 16 YEL
- 4-JW 14 YEL
- 5-JU 14 YEL
- 6-HS 16 YEL
- 7-HT 16 WHT
- 8-HS 16 YEL
- 9-HT 16 WHT
- 10-JB 14 YEL
- 11-JM 14 WHT
- 12-JJ 14 YEL

CONNECTS TO  
MONITOR SOLAR  
CHARGER INDICATOR LAMP 

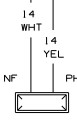

CONNECTS TO  
A/C CORD  
(LOCATED BEHIND  
THERMOSTAT) 



 SEE WIRING DIAGRAM-AC/HEAT/EMS FOR ADDITIONAL INFORMATION.

 SEE MANUFACTURER'S DIAGRAM FOR ADDITIONAL INFORMATION.

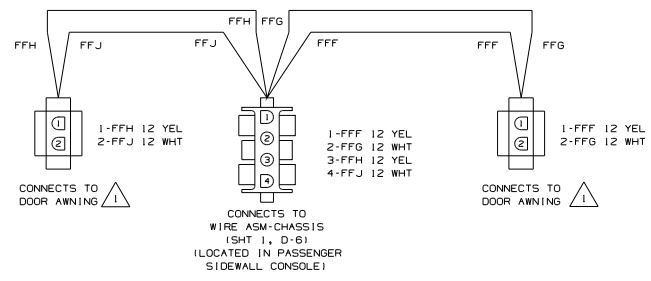
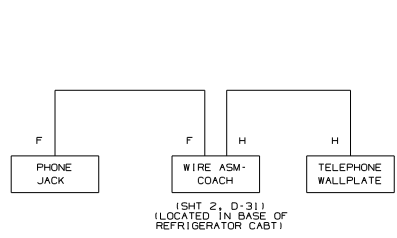
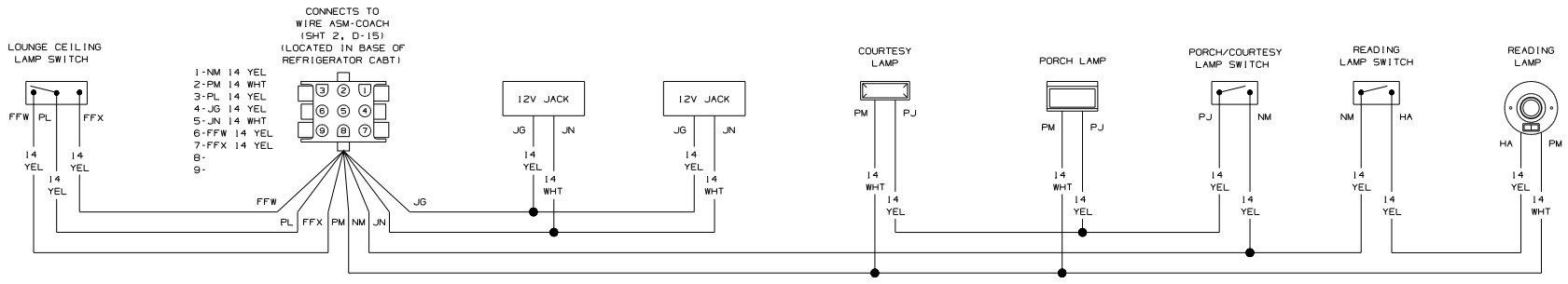

NOTES:  
1 SEE MANUFACTURER'S DIAGRAM FOR ADDITIONAL INFORMATION.

WIRING DIAGRAM-SIDEWALL, RIGHT  
(WIRE ASM 138165)

FIRST CLASS	
02 P36L/LD/G/CD	
DO NOT SCALE DRAWING	
TITLE: WIRING DIAGRAM-BODY, 12V	
SHEET 5	PART NO 137995

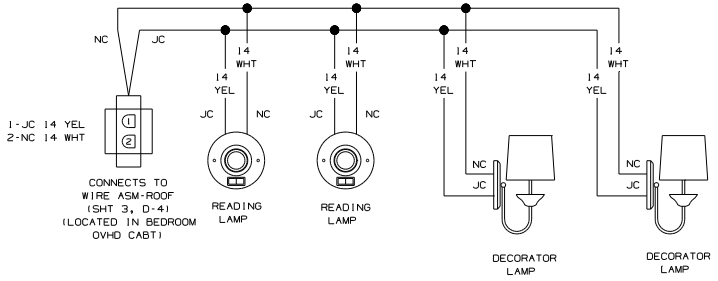

WIRING DIAGRAM-OVHD  
WIRE ASM 133231-02

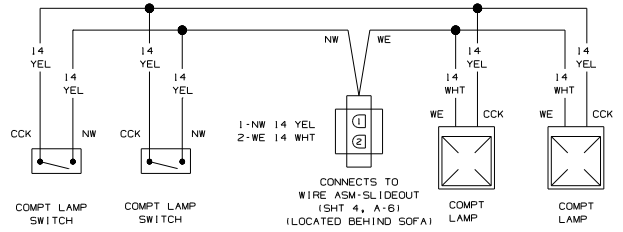

WIRING DIAGRAM-COMPT LAMPS  
WIRE ASM 138219

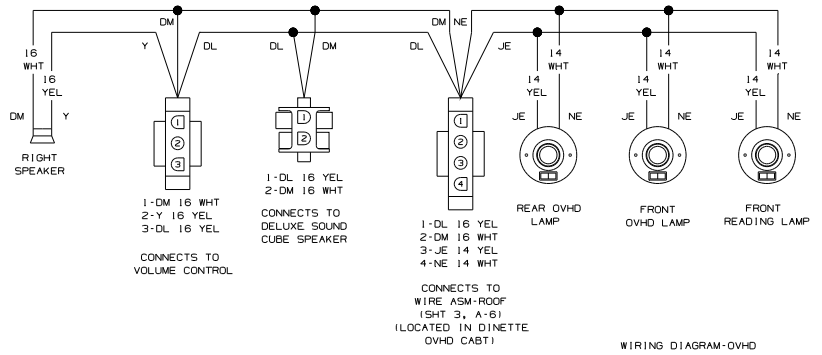

WIRING DIAGRAM-OVHD  
WIRE ASM 133125

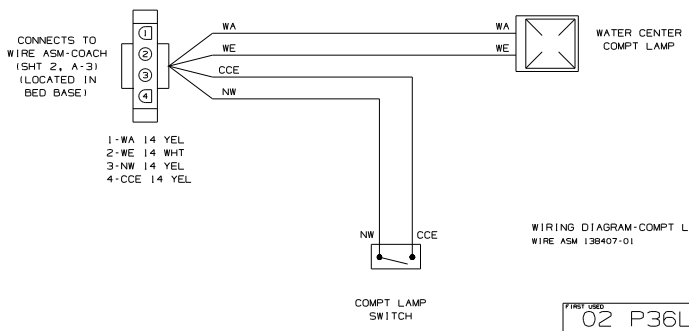

WIRING DIAGRAM-COMPT LAMPS  
WIRE ASM 138407-01

FIRST CLASS	
02 P36L/LD/G/CD	
DO NOT SCALE DRAWING	
TITLE: WIRING DIAGRAM-BODY,12V	
SHEET 6	PART NO 137995

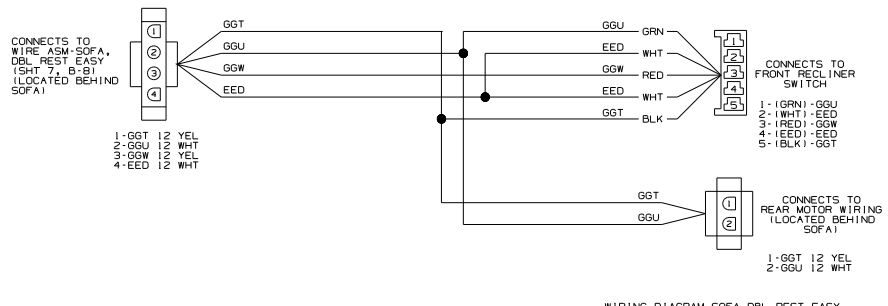
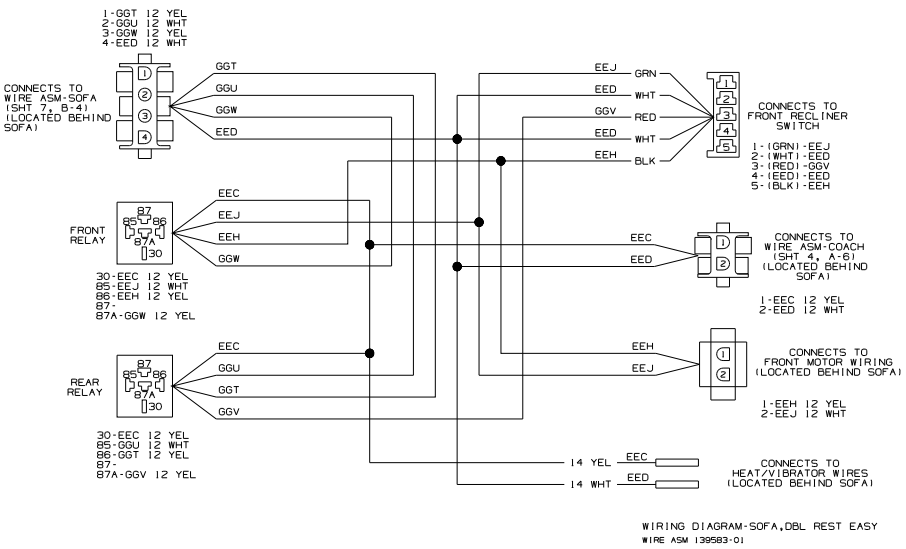
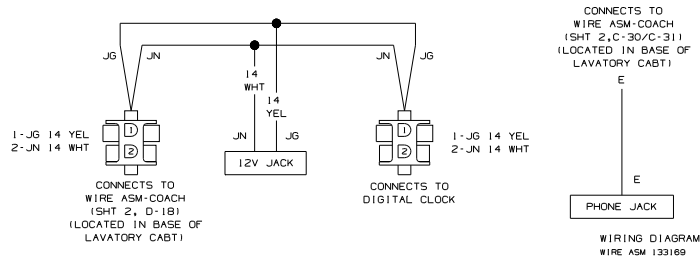
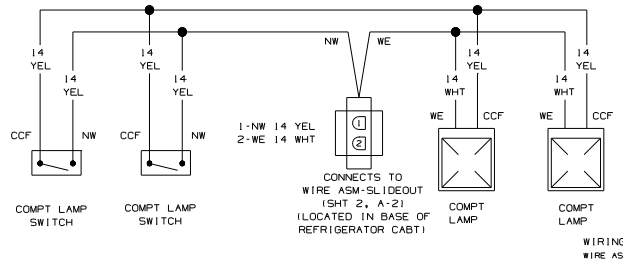
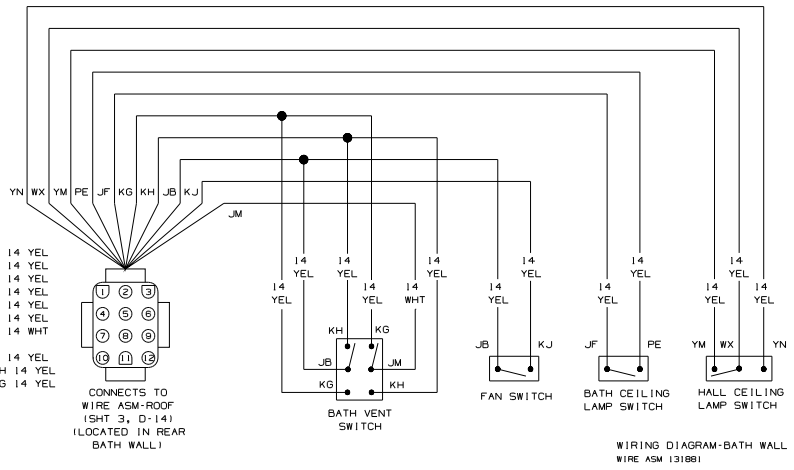

FIRST USED	02 P36LD
TITLE	DO NOT SCALE DRAWING
TITLE	WIRING DIAGRAM-BODY, 12V
SHEET 7	PART NO 137995

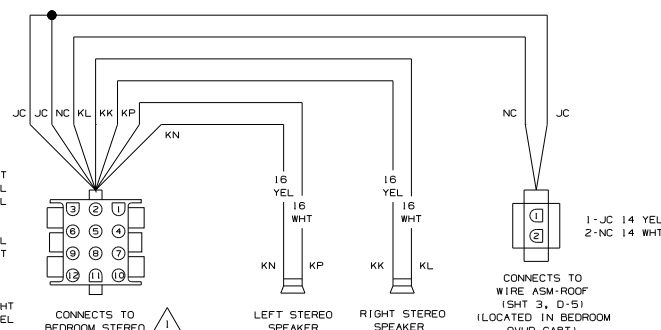

- 1-NC 14 WHT
- 2-JC 14 YEL
- 3-JC 14 YEL
- 4-
- 5-
- 6-KN 16 YEL
- 7-KL 16 WHT
- 8-
- 9-
- 10-
- 11-KP 16 WHT
- 12-KK 16 YEL

WIRING DIAGRAM-REAR STEREO  
WIRE ASM 124336

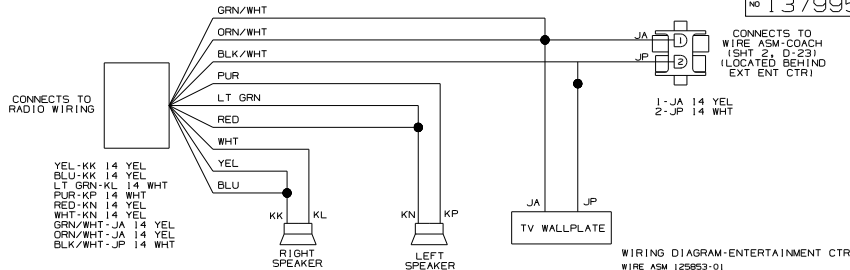

- YEL-KK 14 YEL
- BLU-KK 14 YEL
- LT GRN-KL 14 WHT
- PUR-KP 14 WHT
- RED-KN 14 YEL
- WHT-KN 14 YEL
- GRN/WHT-JA 14 YEL
- GRN/WHT-JA 14 YEL
- BLK/WHT-JP 14 WHT

WIRING DIAGRAM-ENTERTAINMENT CTR  
WIRE ASM 125953-01

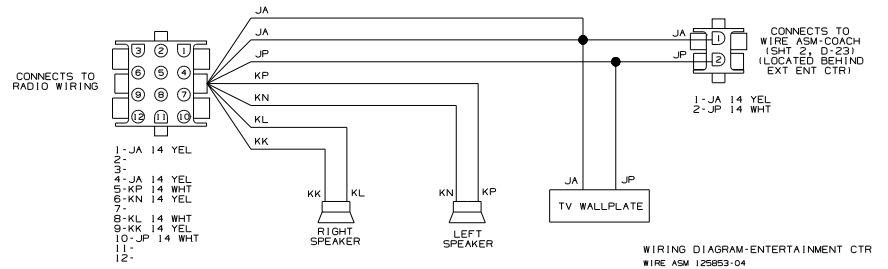

- 1-JA 14 YEL
- 2-
- 3-
- 4-JA 14 YEL
- 5-KP 14 WHT
- 6-KN 14 YEL
- 7-
- 8-KL 14 WHT
- 9-KK 14 YEL
- 10-JP 14 WHT
- 11-
- 12-

WIRING DIAGRAM-ENTERTAINMENT CTR  
WIRE ASM 125953-04

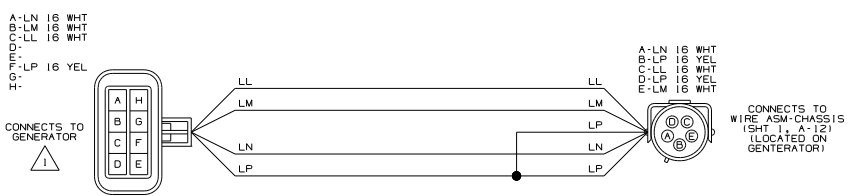

- A-LN 16 WHT
- B-LM 16 WHT
- C-LL 16 WHT
- D-
- E-
- F-LP 16 YEL
- G-
- H-

WIRING DIAGRAM-GEN ADAPTER,LP  
WIRE ASM 130332-01

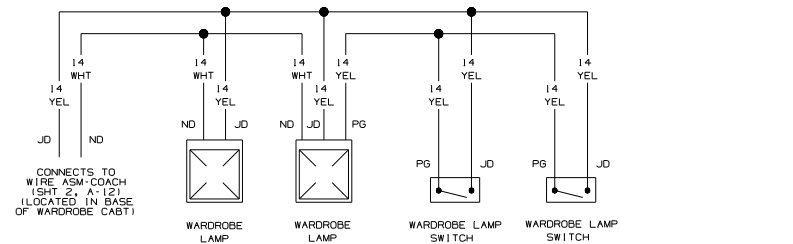

- 14 WHT
- 14 YEL
- 14 WHT
- 14 YEL
- 14 WHT
- 14 YEL
- 14 YEL
- 14 YEL

WIRING DIAGRAM-SLIDOUT,REAR  
WIRE ASM 137456

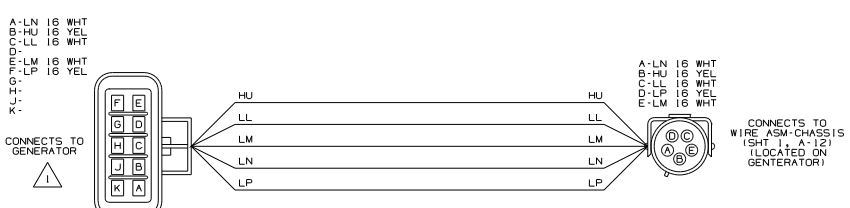

- A-LN 16 WHT
- B-HU 16 YEL
- C-LL 16 WHT
- D-LM 16 WHT
- E-LM 16 WHT
- F-LP 16 YEL
- G-
- H-
- J-
- K-

WIRING DIAGRAM-GEN ADAPTER,DIESEL  
WIRE ASM 130332-02

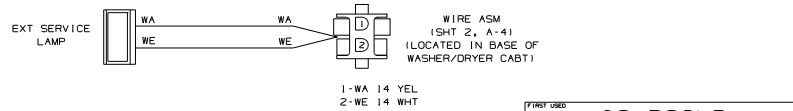

- 1-WA 14 YEL
- 2-WE 14 WHT

WIRING DIAGRAM-SIDEWALL,RR  
WIRE ASM 133169

SEE MANUFACTURER'S DIAGRAM FOR ADDITIONAL INFORMATION.

FIRST USED		02 P36LD	
DO NOT SCALE DRAWING			
TITLE: WIRING DIAGRAM-BODY,12V			
SHEET 8	PART NO	137995	