



**DANGER**

**Danger of electrical shock, burns or death.** Always remove all power sources before attempting any repair, service or diagnostic work. Power can be present from shore power, generator, inverter or battery. All power sources must be disabled and secured before performing any service.



**CAUTION**

If you lack the skills, tools or equipment to perform diagnostic or repair work leave such work to an authorized Winnebago Industries dealer or other qualified shop.

DWG NO	8
137993-01	WIN
137993-02	ITA

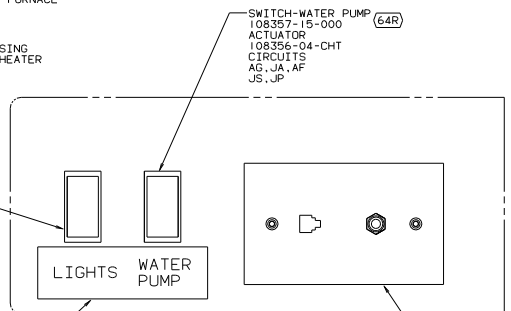
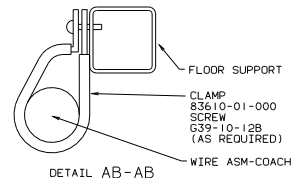
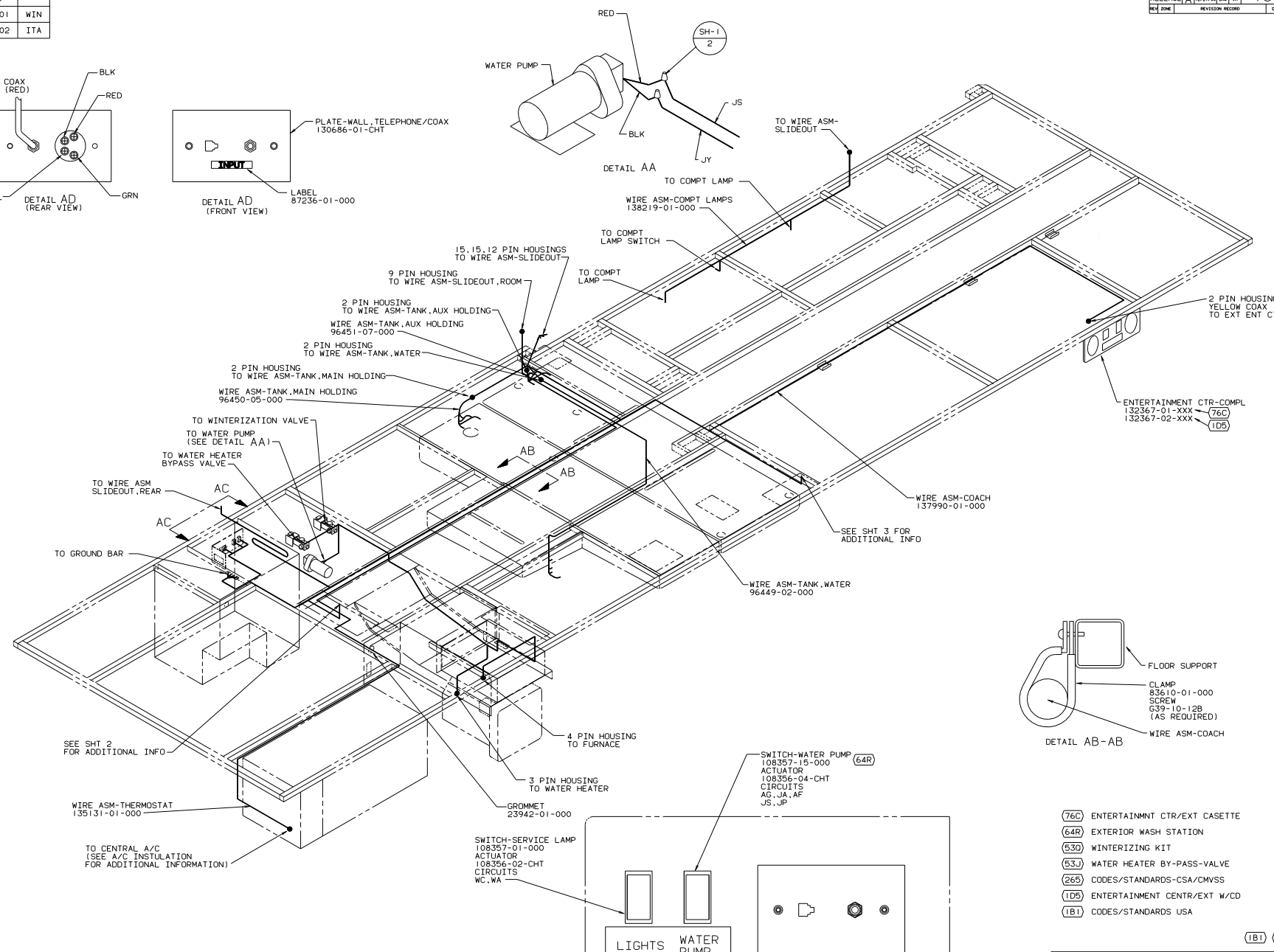
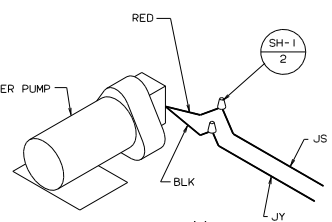
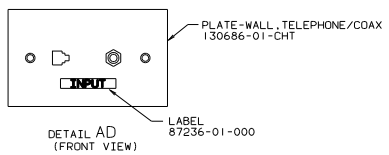
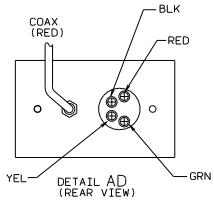

- (76C) ENTERTAINMENT CTR/EXT CASSETTE
- (64R) EXTERIOR WASH STATION
- (53O) WINTERIZING KIT
- (53J) WATER HEATER BY-PASS VALVE
- (26S) CODES/STANDARDS-CSA/CMYSS
- (1DS) ENTERTAINMENT CTR/EXT W/CD
- (1B1) CODES/STANDARDS USA

(1B1) (26S)

WIREING INSTL-BODY, 12V(BL)

DATE	UNSPECIFIED TOLERANCES ARE:	
DATE	ONE PLACE (X.XX)	UNLESS OTHERWISE SPECIFIED
DATE	TWO PLACE (X.XX X)	
DATE	THREE PLACE (X.XX X)	
DATE	FOUR PLACE (X.XX X X)	

WIRING INSTL-BODY, 12V(BL)

SCALE: NONE  
 SHEET: 1 OF 6

NOTES:

1. ALL WIRES TO BE CLAMPED WITH CLAMP 10495-01-000 OR CLIP 80734-02-000 EVERY 700. USE SCREW G67-10-12B UNLESS OTHERWISE SPECIFIED.
2. CLAMP TO FLOOR SUPPORT TUBES AS NECESSARY WITH CLAMP 10497-01-000.
3. WIRES THAT REST ON WIRE TRAYS ARE TO BE TIES DOWN WITH WIRE TIE 8543-02-000.

WINTERIZATION BYPASS

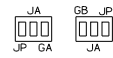

SWITCH-BYPASS SWITCH-WINTERIZATION (SUPPLIED W/KIT) SCREW G12-05-16U (4)

DETAIL BE (530)

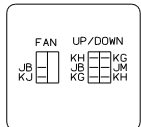

SWITCH-ROCKER 135740-01-CHT 135740-03-CHT SWITCH-BASE 135741-02-CHT SWITCH-BEZEL 135742-07-CHT SCREW G11-08-08U (4)

DETAIL BH (715)

LIGHT-READING (2) 132427-01-CHT SCREW G13-06-16U (4) CONNECTOR 58028-01-000 (4)

(20F) SPEAKER-RADIO, TV 94097-01-000 SCREW G11-08-08B (2)

(21V) SPEAKER-CUBE, MTS 24883-02-000 SCREW G11-08-08B (3)

(29D) MONITOR PANEL 133004-03-CHT SCREW G13-06-06I (2)

LAMP-WALL 119258-34-CHT BULB 117806-01-000 (2) LAMP-WALL 119258-25-CHT SHADE-LAMP BULB 65201-09-000 67479-01-000(2) SCREW 667-10-24J (2) CONNECTOR 58028-01-000 (2)

CONTROL-VOLUME SPEAKER 133089-01-000 (20F)

WIRE ASM-SLIDEOUT 138218-01-000

SWITCH (SEE DETAIL BA)

WIRE ASM-COMPT LAMPS (SEE SHT 5 FOR MORE INFO)

MONITOR 127002-05-000 SCREW G12-08-08U (2)

THERMOSTAT-A/C AND FURNACE 105620-14-000 105620-15-000 (SEE DETAIL BG)

(29C) (29H) (9L1)

REMOTE PANEL INVERTER/CHARGER (79J) 113685-05-000 CABLE ASM-MODULE JACK 50' 113685-06-000 CONDUIT 41953-09-000 (7000)

TO SIDE MARKER LAMP

2.12.15(2) PIN HOUSINGS TO WIRE ASM-COACH

SWITCH (SEE DETAIL BB)

WIRE ASM-COACH FROM BELOW FLOOR (SEE SHT 1 FOR MORE INFO)

SWITCH (SEE DETAIL BH)

TO WIRE ASM-SIDEWALL

SWITCH CEILING 135740-01-CHT BASE 135741-01-CHT BEZEL 135742-07-CHT SCREW G11-06-16U (4)

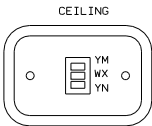

DETAIL BB

ATISLE

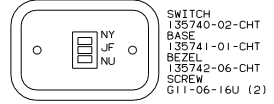

DETAIL BA

- (WIN) WINNEBAGO ONLY
- (ITA) ITASCA ONLY
- (29H) HEAT PUMP-A/C CENTRAL
- (29C) A/C CENTRAL
- (26L) REAR STEREO SYSTEM W/CASSETTE
- (25E) REAR STEREO SYSTEM W/CD
- (79J) INVERTER/CHARGER-1.500 WATT
- (530) WINTERIZING KIT
- (715) VENT-POWER
- (9L1) HOME COMFORT PLUS PACKAGE
- (265) CODES/STANDARDS-CSA/CMVSS
- (21V) SOUND SYSTEM DELUXE
- (20F) DELUXE SOUND SYSTEM-WITHOUT
- (1B1) CODES/STANDARDS USA

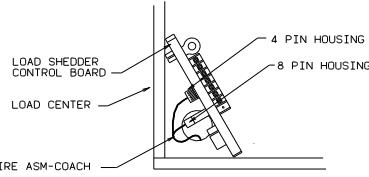

DETAIL BD

FOR ELECTRICAL TORQUE SPECIFICATIONS SEE DWG NO. 128783-01-000

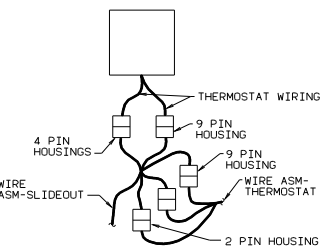

DETAIL BG

WITHOUT (29H) PLUG THE TWO, TWO PIN HOUSINGS TOGETHER ON WIRE ASM-SLIDEOUT.

NOTES:

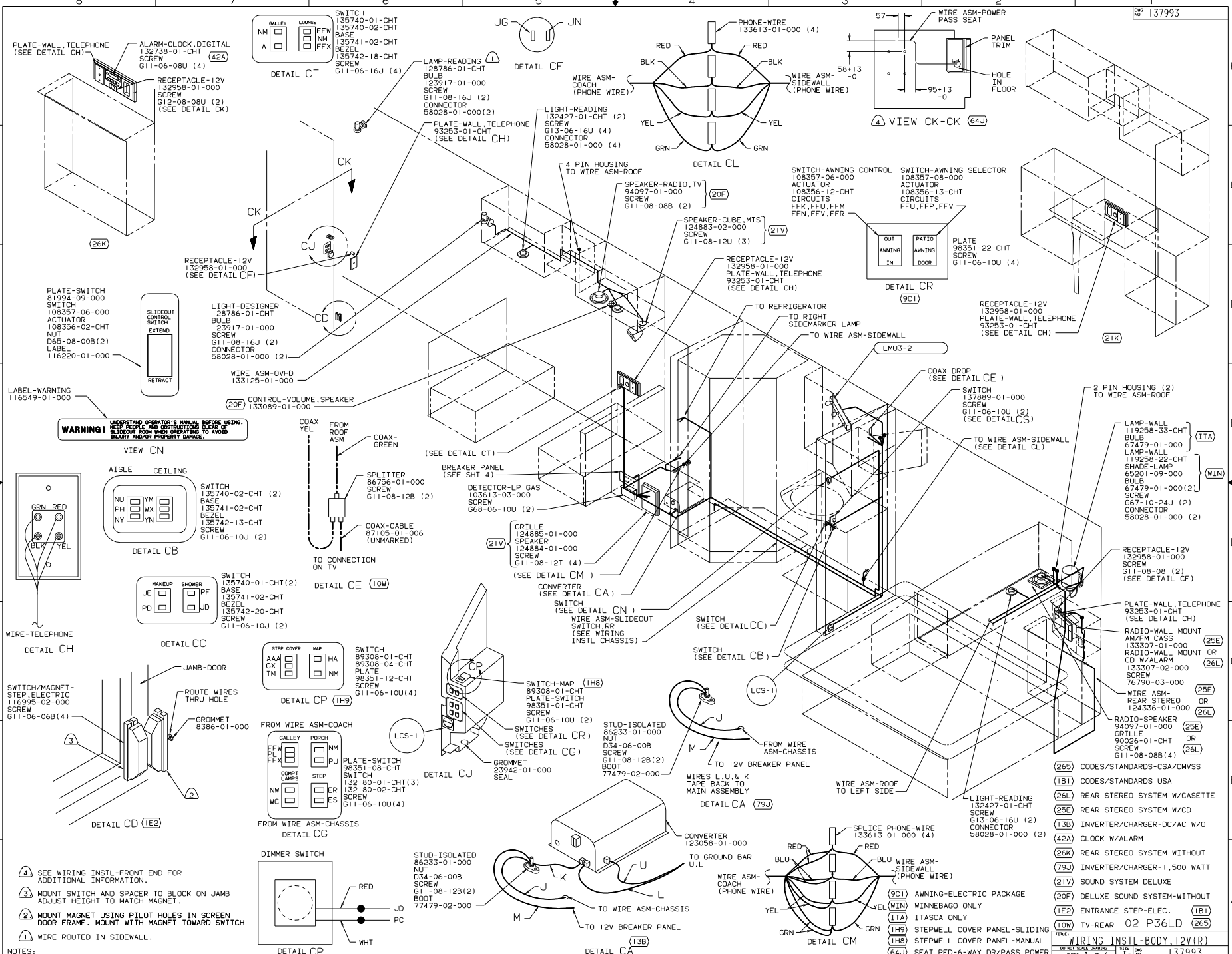

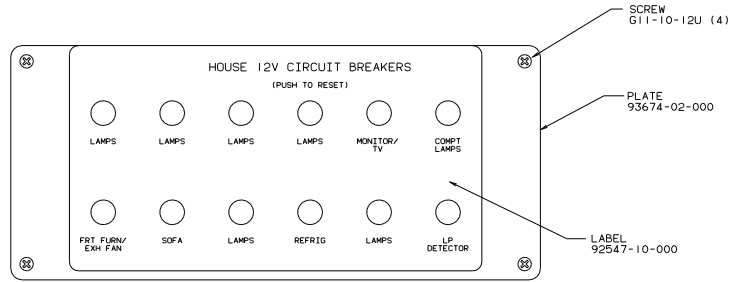

CIRCUIT BREAKER (FRONT VIEW)

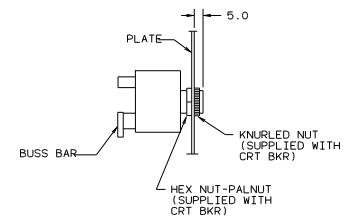

SECTION DA-DA

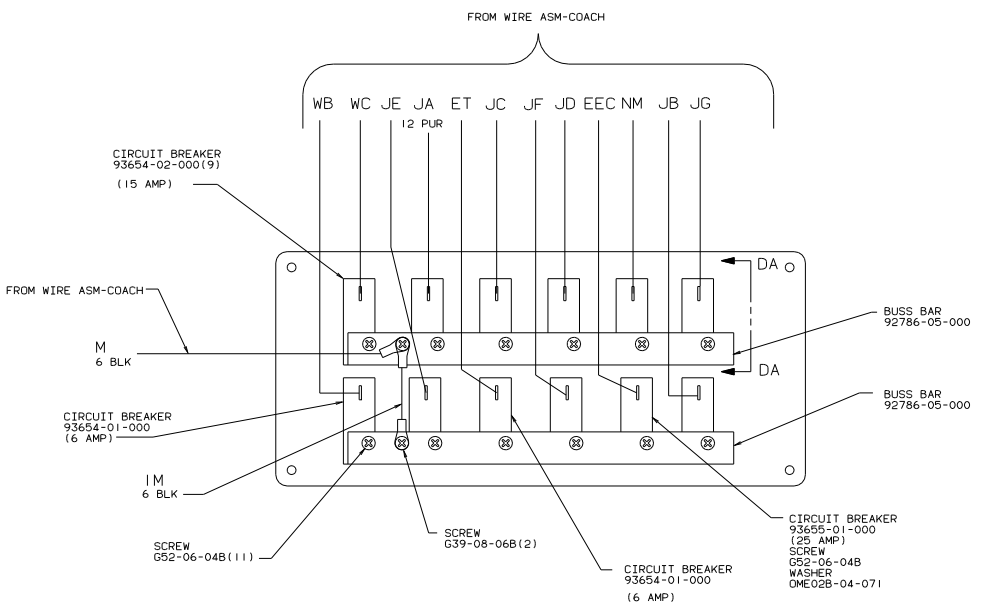

CIRCUIT BREAKER (BACK VIEW)

- DETAIL DA-DA
- (265) CODES/STANDARDS-CSA/CMVSS
  - (1B1) CODES/STANDARDS USA
  - (9L1) HOME COMFORT PLUS PACKAGE
  - (29H) HEAT PUMP-A/C CENTRAL

TITLE		02 P36LD	
WIRING INSTL-BODY,12V(BP)		137993	
DO NOT SCALE DRAWING	SHEET NO	I F NO	
SHEET 4 OF 6			

CONNECT BLUE WIRES FROM RESET TO THE BLUE WIRES WITH SPADE TERMINALS ON A/C CORD WITH (29H) & (9L1) FEATURE.

NOTES:

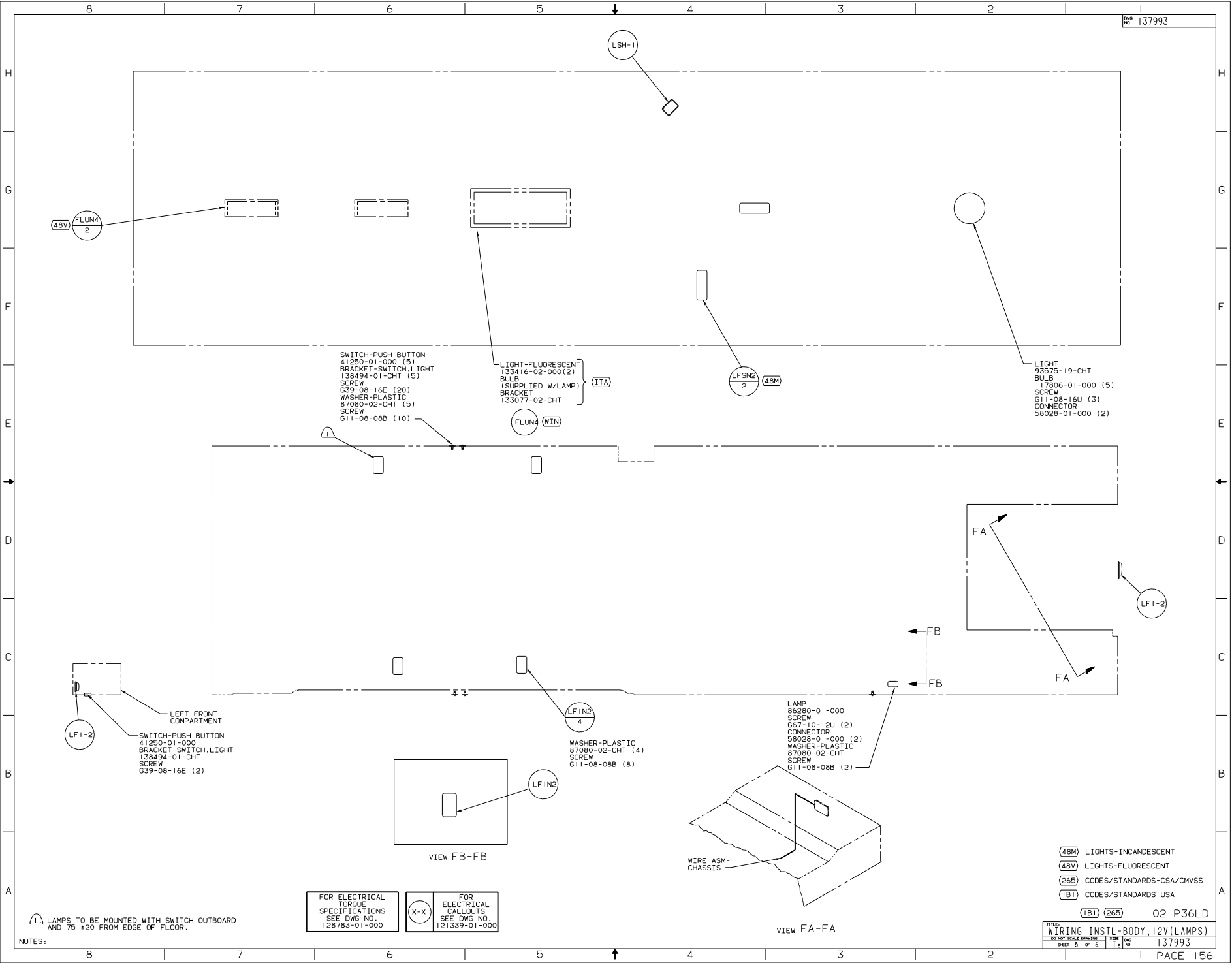

SWITCH-PUSH BUTTON  
41250-01-000 (5)  
BRACKET-SWITCH, LIGHT  
138494-01-CHT (5)  
SCREW  
G39-08-16E (20)  
WASHER-PLASTIC  
87080-02-CHT (5)  
SCREW  
G11-08-08B (10)

LIGHT-FLUORESCENT  
133416-02-000(2)  
BULB  
(SUPPLIED W/LAMP) (ITA)  
BRACKET  
133077-02-CHT

LIGHT  
93575-19-CHT  
BULB  
117806-01-000 (5)  
SCREW  
G11-08-16U (3)  
CONNECTOR  
58028-01-000 (2)

LEFT FRONT  
COMPARTMENT  
SWITCH-PUSH BUTTON  
41250-01-000  
BRACKET-SWITCH, LIGHT  
138494-01-CHT  
SCREW  
G39-08-16E (2)

WASHER-PLASTIC  
87080-02-CHT (4)  
SCREW  
G11-08-08B (8)

LAMP  
86280-01-000  
SCREW  
G67-10-12U (2)  
CONNECTOR  
58028-01-000 (2)  
WASHER-PLASTIC  
87080-02-CHT  
SCREW  
G11-08-08B (2)

FOR ELECTRICAL TORQUE SPECIFICATIONS SEE DWG NO. 128783-01-000	FOR ELECTRICAL CALLOUTS SEE DWG NO. 121339-01-000
--	--

(48M) LIGHTS-INCANDESCENT  
(48V) LIGHTS-FLUORESCENT  
(265) CODES/STANDARDS-CSA/CMVSS  
(IB1) CODES/STANDARDS USA  
(IB1) (265) 02 P36LD

NOTES:  
LAMP TO BE MOUNTED WITH SWITCH OUTBOARD  
AND 75 ±20 FROM EDGE OF FLOOR.

TITLE  
WIRING INSTL - BODY, 12V (LAMPS)  
DWG NO 137993  
SHEET 5 OF 6

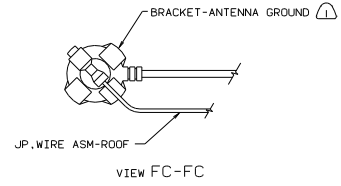
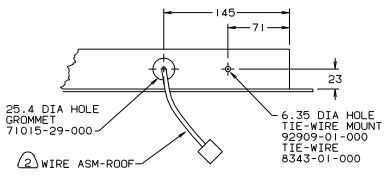
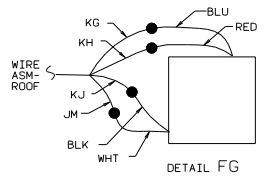

- (26L) ANTENNA-RADIO 90944-01-000
- (26E) EXTENDER-SHAFT, ANTENNA 109889-04-000
- BRACKET-ANTENNA GROUND 108847-01-000
- SEAL 77069-02-000(2)
- CABLE EXT 77069-02-000(2)

- (290) PANEL-SOLAR 10 WATT 115504-01-000
- SCREW G11-08-16U(4)
- (SEE DETAIL FA)

- (76C) ANTENNA-RADIO 90944-01-000
- (1D5) EXTENDER-SHAFT, ANTENNA 109889-04-000
- BRACKET-ANTENNA GROUND 108847-01-000
- SEAL 77069-02-000(3)

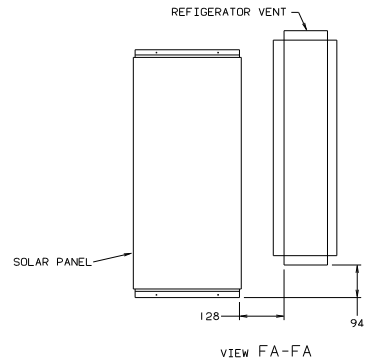
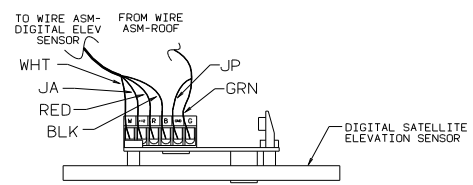

- (26L) REAR STEREO SYSTEM W/CASSETTE
- (26E) REAR STEREO SYSTEM W/CD
- (1D5) ENTERTAINMENT CENTR/EXT W/CD
- (76C) ENTERTAINMENT CTR/EXT CASSETTE
- (290) SOLAR PANEL-10 WATT
- (265) CODES/STANDARDS-CSA/CMVSS
- (1B1) CODES/STANDARDS USA

NOTES:  
 (2) FASTEN TO VENT.  
 (1) WRAP BRACKET LEGS AROUND ANTENNA BASE.