



**DANGER**

**Danger of electrical shock, burns or death.** Always remove all power sources before attempting any repair, service or diagnostic work. Power can be present from shore power, generator, inverter or battery. All power sources must be disabled and secured before performing any service.



**CAUTION**

If you lack the skills, tools or equipment to perform diagnostic or repair work leave such work to an authorized Winnebago Industries dealer or other qualified shop.

REV DATE		DWD NO	
A 12/19/00		139437	
REV ZONE	REVISION RECORD	DATE	DR-ORIG
A	CONVERT TO US	01/08/02	ENTSEK

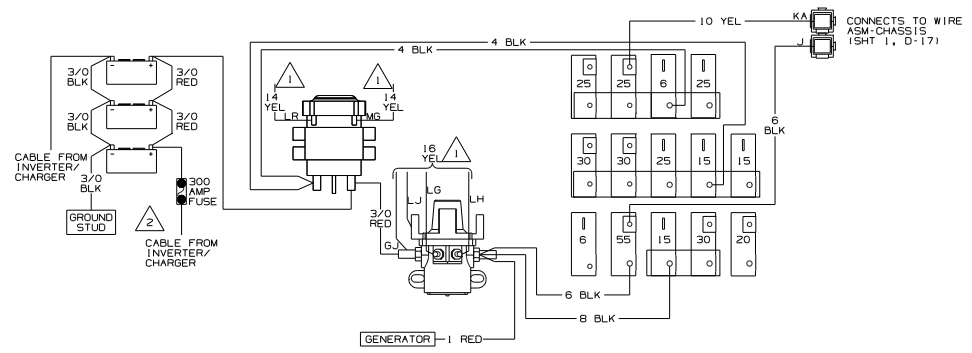

**WINNEBAGO**

DATE	DATE
DWR	12/04/00
P.E.	ALL DIMENSIONS ARE IN MILLIMETERS
M.E.	FIRST USED
DDW	02 P366D
UNSPECIFIED TOLERANCES ARE:	MATERIAL:
ANGLE DIM 100	F
ONE-PLACE 15.00	F
TWO-PLACE 15.00	F
ANGLE	F
THIRD ANGLE PROJECTION	F

**DO NOT SCALE DRAWING**

TITLE:  
WIRING DIAGRAM-BODY, 12V

F1 SHEET 1 OF 8 PART NO 139437

REF: 1 PAGE 162

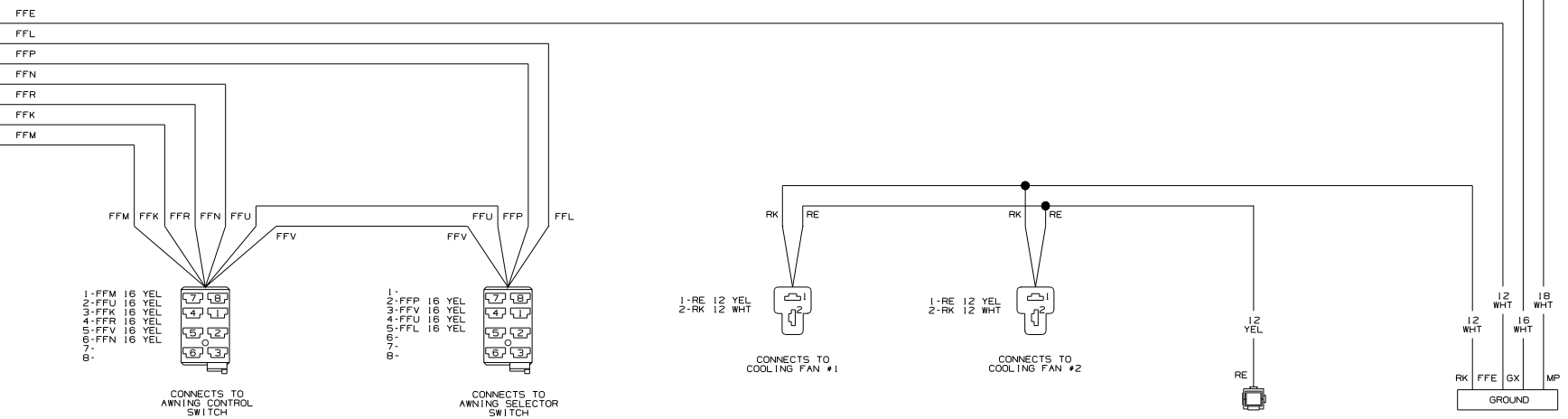
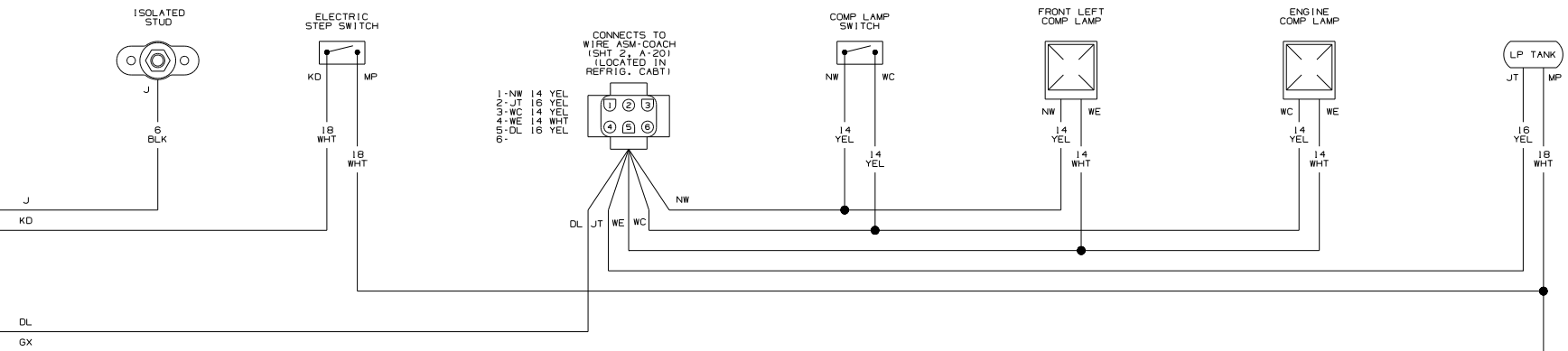

WIRING DIAGRAM-CHASSIS  
(WIRE ASM 137992)

- A1-AAX 16 WHT
- A2- 16 WHT
- A3- 16 WHT
- B1-BBM 16 YEL
- B2-BBN 16 YEL
- B3-CCY 16 YEL
- B4-CCZ 16 YEL
- C1-DDA 16 YEL
- C2-TM 16 WHT
- D1-LL 16 WHT
- D2-LM 16 WHT
- D3-LN 16 WHT
- D4-HU 16 YEL
- E1-MM 14 YEL
- E2-HS 16 YEL
- F1- 16 YEL
- F2- 16 YEL
- G1-DL 16 YEL
- G2-DM 16 WHT
- G3-DJ 14 YEL
- G4-OK 16 WHT
- H1-AAA 16 WHT
- H2- 16 WHT
- H3-ER 16 YEL
- H4- 16 WHT
- J1- 16 WHT
- J2-WH 16 YEL
- J3-ER 16 YEL
- J4- 16 WHT
- K1-FFD 12 YEL
- K2- 16 WHT
- K3-AAW 16 YEL

CONNECTS TO WIRE ASM-IP MAIN

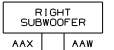
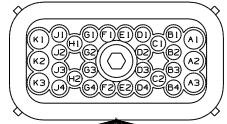

STEP COVER SWITCH



ELECTRIC STEP SWITCH



CONNECTS TO ELECTRIC STEP



WIRE ASM-CRT BRK POWER IN FRONT ELECTRICAL BOX (SHT 1, D-4)

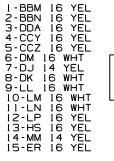
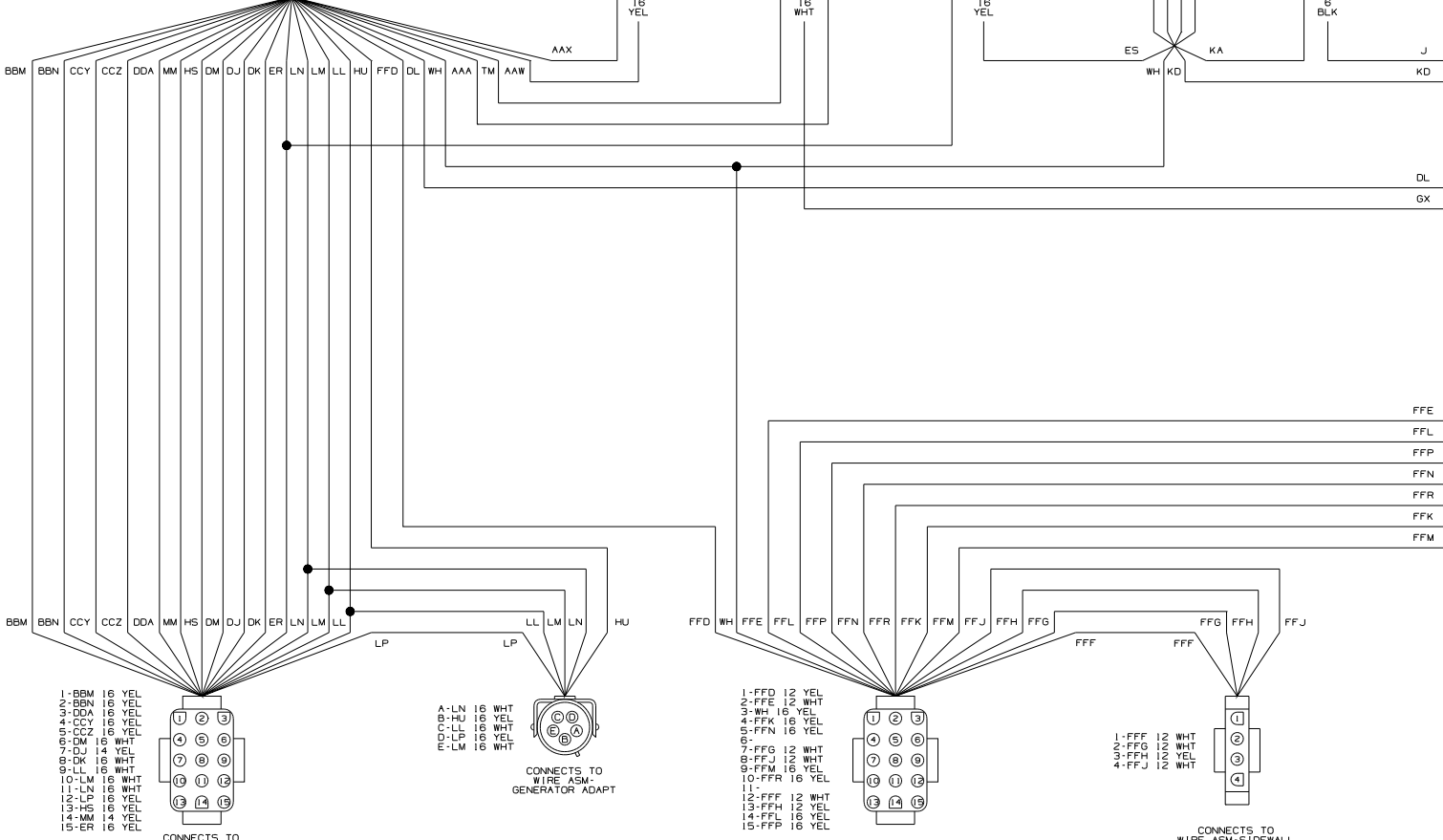

CONNECTS TO WIRE ASM-COACH (SHT 2, A-38) (LOCATED IN REFRIG. CABT.)



CONNECTS TO GENERATOR ADAPT

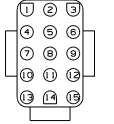

CONNECTS TO AWNING CONTROL BOX

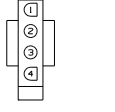

CONNECTS TO WIRE ASM-SIDEWALL

2 WITHOUT INVERTER/CHARGER THERE ARE ONLY 2 BATTERIES AND NO 300 AMP FUSE.

1 SEE MANUFACTURERS DIAGRAM FOR ADDITIONAL INFORMATION.

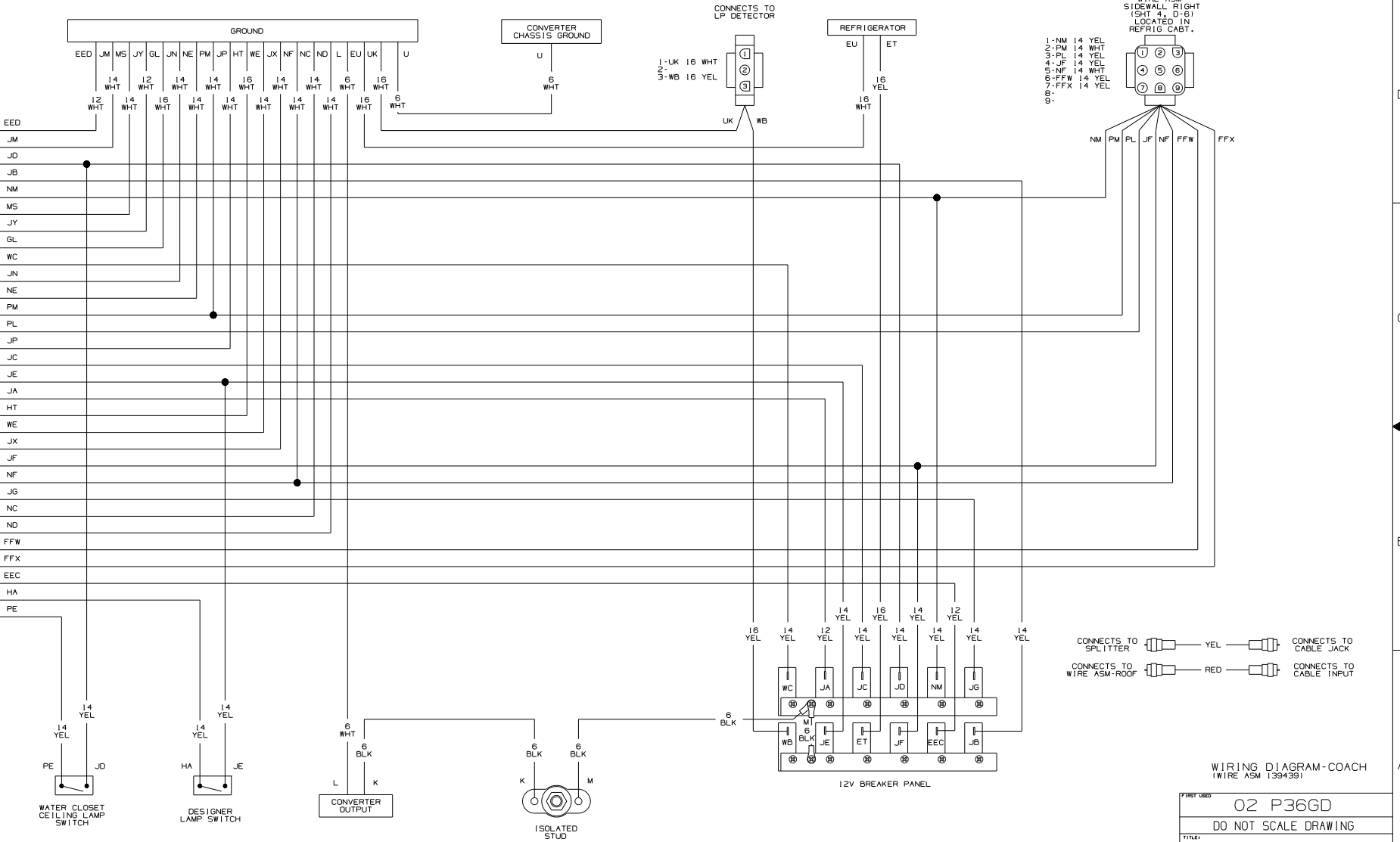

- 1-NM 14 YEL
- 2-PM 14 WHT
- 3-PL 14 YEL
- 4-JF 14 YEL
- 5-NF 14 WHT
- 6-FFW 14 YEL
- 7-FFX 14 YEL
- 8-
- 9-

CONNECTS TO WIRE ASM-5 SIDEWALL RIGHT (SHT 4, D-6) LOCATED IN REFRIG CABT.

CONNECTS TO SPLITTER  
CONNECTS TO WIRE ASM-ROOF

YEL  
RED

CONNECTS TO CABLE JACK  
CONNECTS TO CABLE INPUT

WIRING DIAGRAM-COACH (WIRE ASM 1394391)

FIRST USED	02 P36GD
TITLE	DO NOT SCALE DRAWING
WIRING DIAGRAM-BODY, 12V	
SHEET 2	PART NO 139437

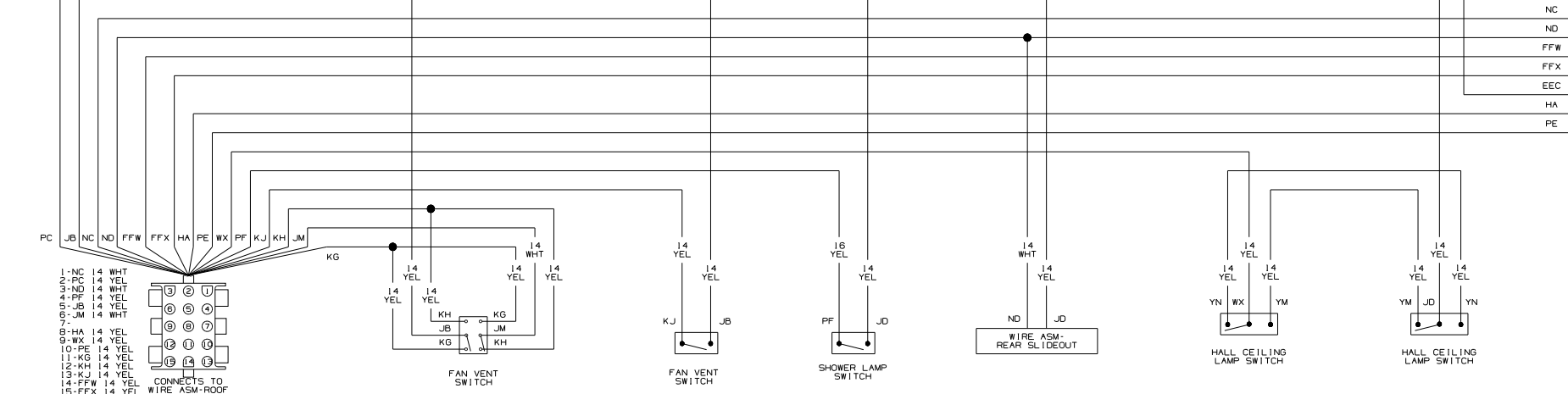
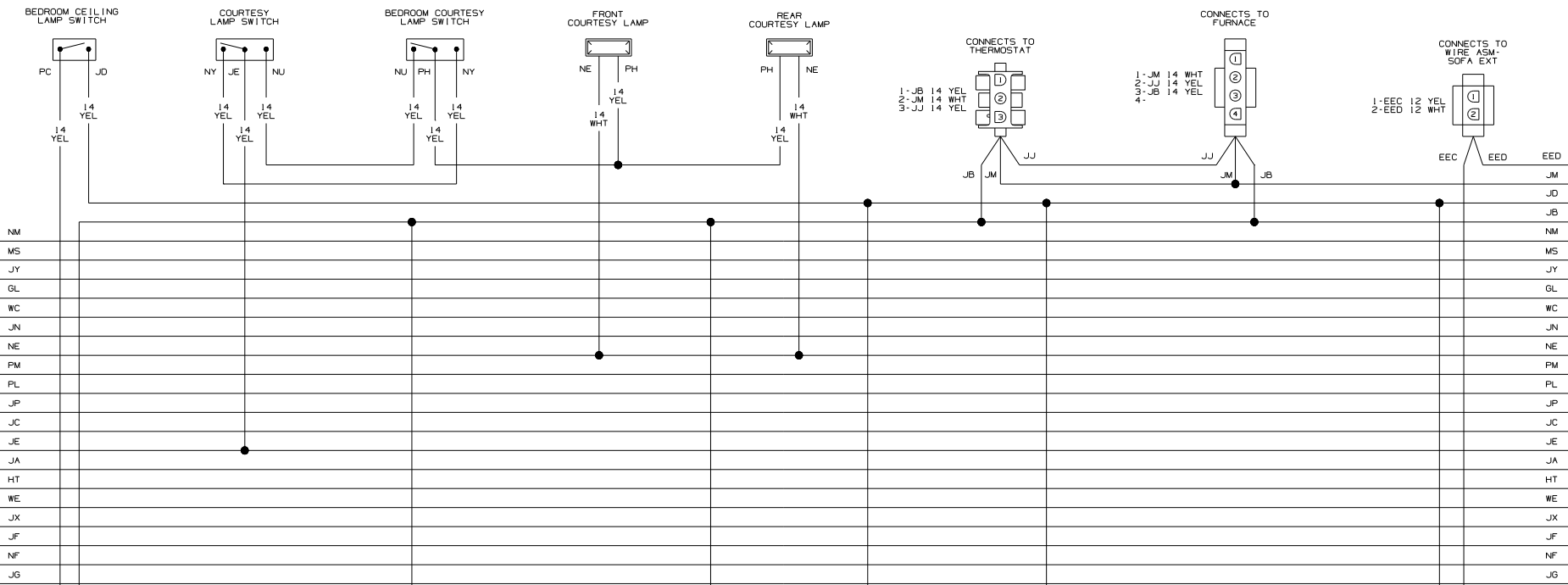

DRESSER COURTESY LAMP SWITCH

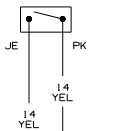

DRESSER COURTESY LAMP

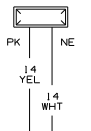

BEDROOM MAKEUP LAMP

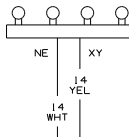

BEDROOM MAKEUP LAMP SWITCH

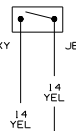

COMP LAMP SWITCH

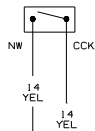

COMP LAMP SWITCH

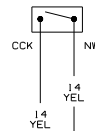

COMP LAMP

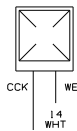

COMP LAMP

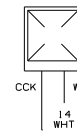

RIGHT SIDE MARKER LAMP

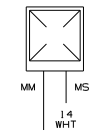

CONNECTS TO WIRE ASM-SIDEWALL RR (SHT 7, D7) (LOCATED BEHIND BDRM\_CLOCK1)

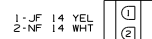

NF JF

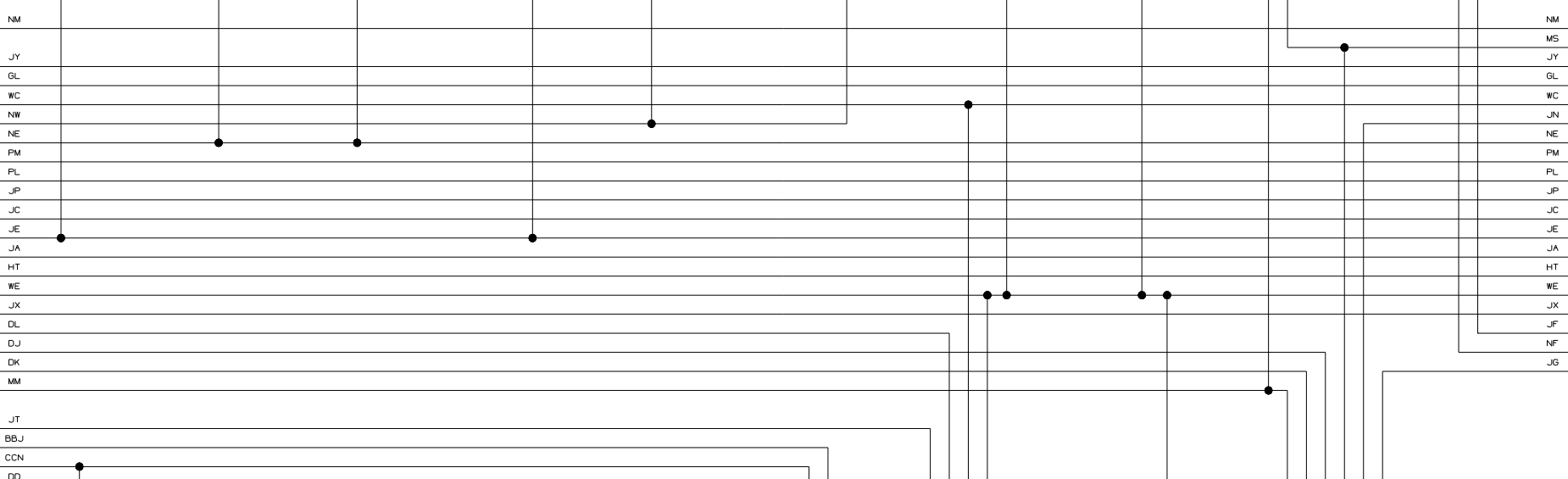

- 1-GRAY 16 YEL
- 2-RED 16 YEL
- 3-GRAY 16 YEL
- 4-BLUE 16 YEL
- 5-YELLOW 16 YEL
- 6-CCP-1 16 YEL
- 7-DD 16 YEL
- 8-WHITE 16 YEL
- 9-CCN 16 YEL

CONNECTS TO A/C CORD

- 1-BBH-1 16 YEL
- 2-CCP-1 16 YEL

CONNECTS TO A/C CORD

- 1-GRAY 16 YEL
- 2-RED 16 YEL
- 3-GRAY 16 YEL
- 4-BLUE 16 YEL
- 5-YELLOW 16 YEL
- 6-BBH-1 16 YEL
- 7-BBJ 16 YEL
- 8-WHITE 16 YEL
- 9-CCN 16 YEL

CONNECTS TO THERMOSTAT

- 1-NW 16 YEL
- 2-JT 16 YEL
- 3-WC 14 YEL
- 4-WE 14 WHT
- 5-DL 16 YEL
- 6-

CONNECTS TO WIRE ASM-CHASSIS (SHT 1, D-14) (LOCATED IN REFRIGERATOR CABT.)

- 1-NW 14 YEL
- 2-WE 14 WHT

CONNECTS TO WIRE ASM-COMP LAMPS (SHT 5, C-6) (LOCATED IN REFRIG. CABT.)

- 1-MM 16 YEL
- 2-MS 14 WHT
- 3-DJ 16 YEL
- 4-DK 16 WHT
- 5-JG 14 YEL
- 6-JN 14 WHT
- 7-RED 16 YEL
- 8-GRN 16 YEL
- 9-

CONNECTS TO WIRE ASM-SLIDEOUT EXTENSION (SHT 5, A-4) (LOCATED BEHIND COUCH)

16 YEL  
16 YEL  
RED GRN  
TELEPHONE INPUT

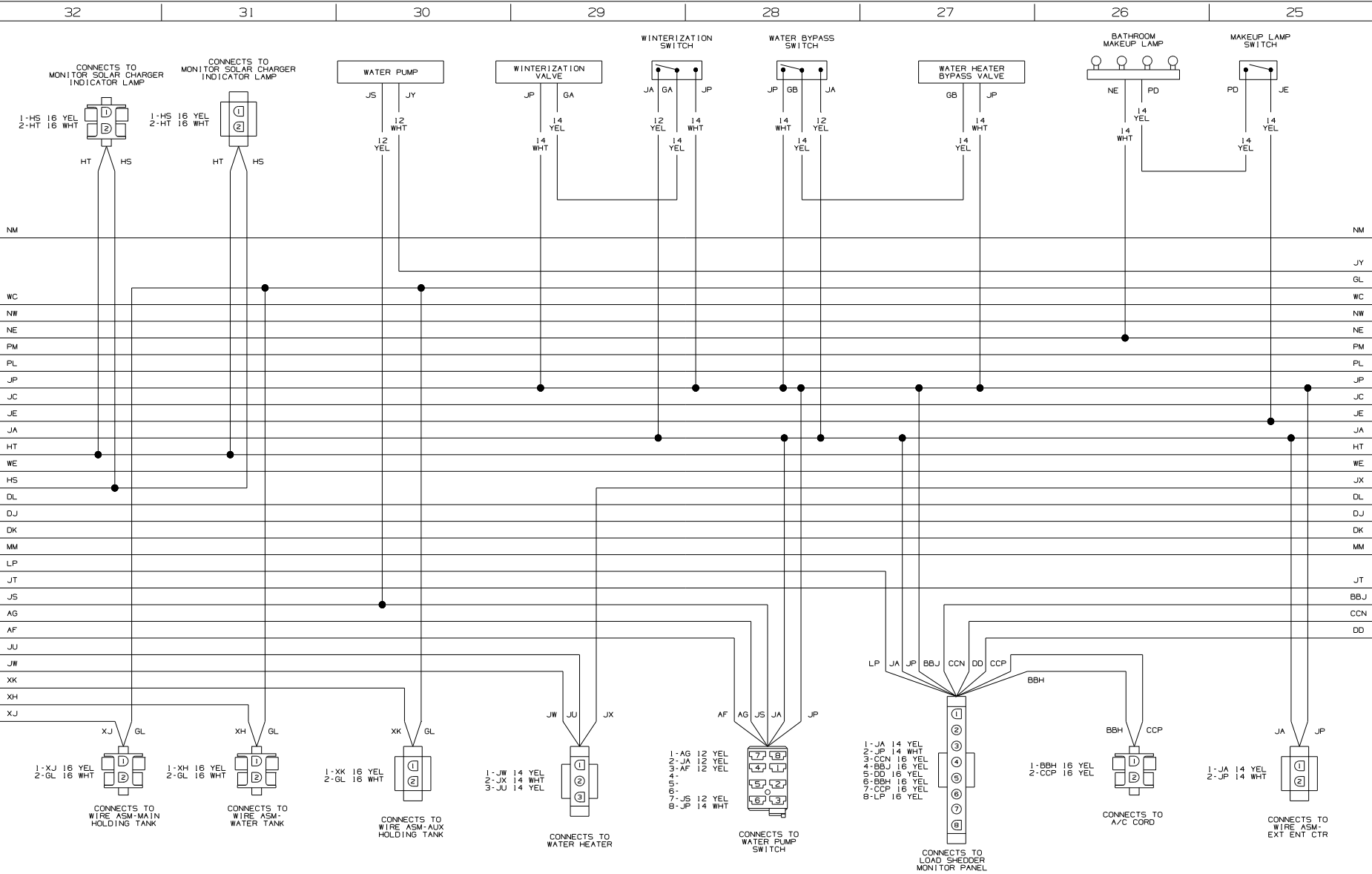



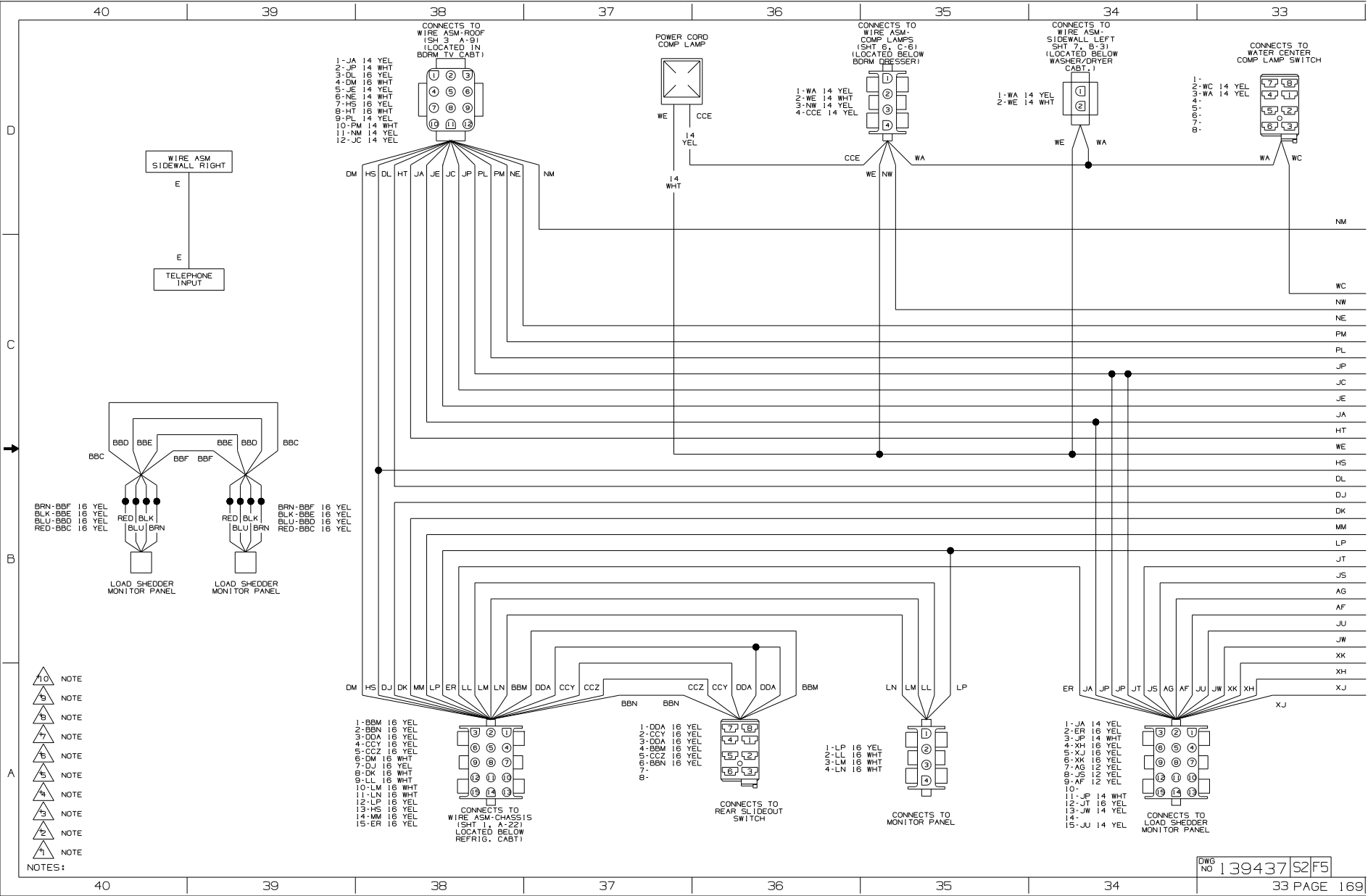

- NOTES:
- 10 NOTE
  - 9 NOTE
  - 8 NOTE
  - 7 NOTE
  - 6 NOTE
  - 5 NOTE
  - 4 NOTE
  - 3 NOTE
  - 2 NOTE
  - 1 NOTE

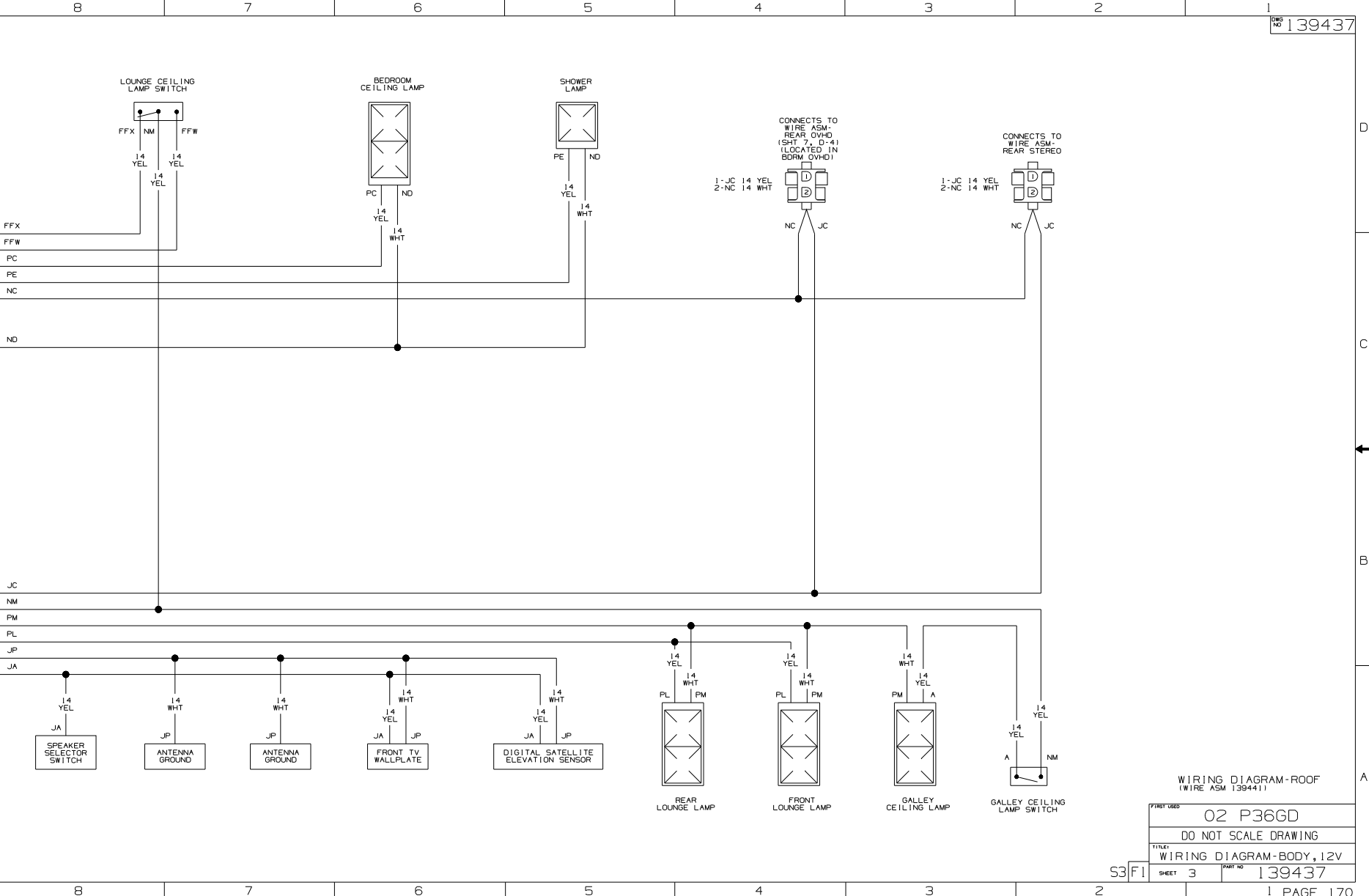

WIRING DIAGRAM-ROOF  
(WIRE ASM 139441)

FIRST USED	02 P36GD	
TITLE	DO NOT SCALE DRAWING	
WIRING DIAGRAM-BODY,12V		
SHEET	3	PART NO 139437

WATER CLOSET  
CEILING LAMP

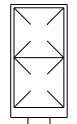

ND PF  
14 YEL  
14 WHT

HALL  
CEILING LAMP

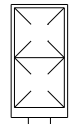

ND WX  
14 YEL  
14 WHT

BATH/VENT

KG KH KJ JM

14 YEL 14 YEL  
14 YEL 14 WHT

BEDROOM  
VENT

JM JB

14 WHT 14 YEL

GALLEY  
VENT

JM JB

14 WHT 14 YEL

CONNECTS TO  
WIRE ASM-COACH  
(SHT 2, A-15)  
(LOCATED IN BORM  
TV CABT-1)

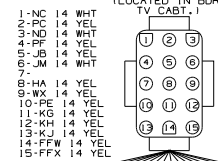

1-NC 14 WHT  
2-PC 14 YEL  
3-ND 14 WHT  
4-PF 14 YEL  
5-JB 14 YEL  
6-JM 14 WHT  
7-  
8-HA 14 YEL  
9-WX 14 YEL  
10-PE 14 YEL  
11-KG 14 YEL  
12-KH 14 YEL  
13-KJ 14 YEL  
14-FFW 14 YEL  
15-FFX 14 YEL

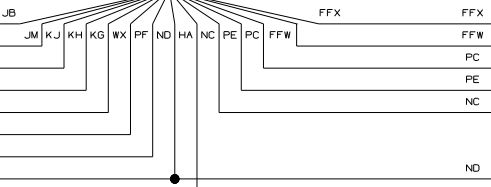

CONNECTS TO  
SWITCHING SYSTEM

CONNECTS TO  
SWITCHING SYSTEM

CONNECTS TO  
ANTENNA DROP



RED

GRN

BLU

CONNECTS TO  
WIRE ASM-COACH

CONNECTS TO  
REAR SPLITTER

CONNECTS TO  
FRONT TV  
WALLPLATE

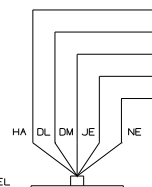

1-DL 16 YEL  
2-DM 16 WHT  
3-JE 14 YEL  
4-NE 14 WHT  
5-HA 14 YEL  
6-

CONNECTS TO  
WIRE ASM-OVHD  
(SHT 8, C-2)  
(LOCATED IN  
GALLEY OVHD)

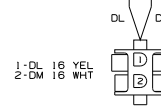

1-DL 16 YEL  
2-DM 16 WHT

CONNECTS TO  
CUBE SPEAKER

A-HS 16 YEL  
B-HT 16 WHT

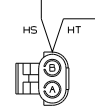

CONNECTS TO  
SOLAR PANEL

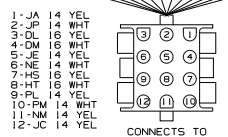

1-JA 14 YEL  
2-JP 14 WHT  
3-DL 16 YEL  
4-DM 16 WHT  
5-JE 14 YEL  
6-NE 14 WHT  
7-HS 16 YEL  
8-HT 16 WHT  
9-PL 14 YEL  
10-PM 14 WHT  
11-NM 14 YEL  
12-JC 14 YEL

CONNECTS TO  
WIRE ASM-COACH  
(SHT 2, D-38)  
(LOCATED IN BORM  
TV CABT)

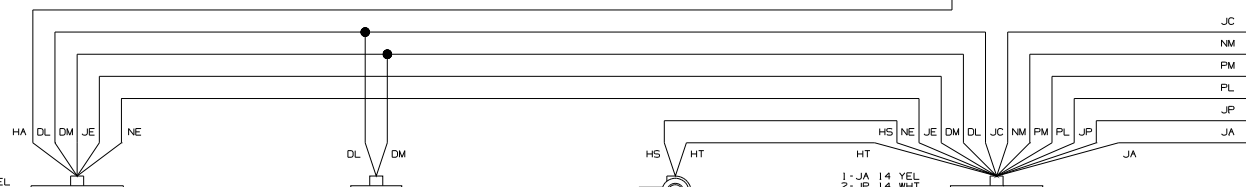

NOTES:

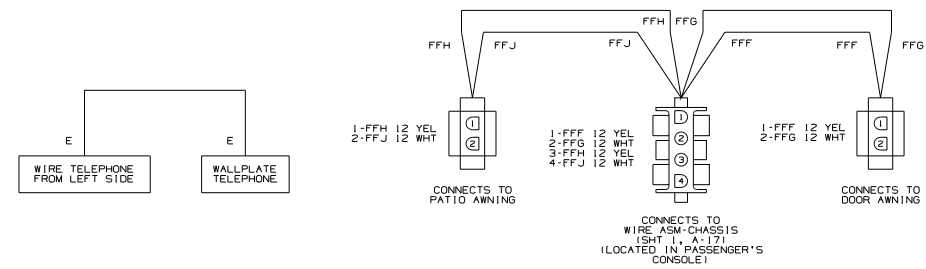
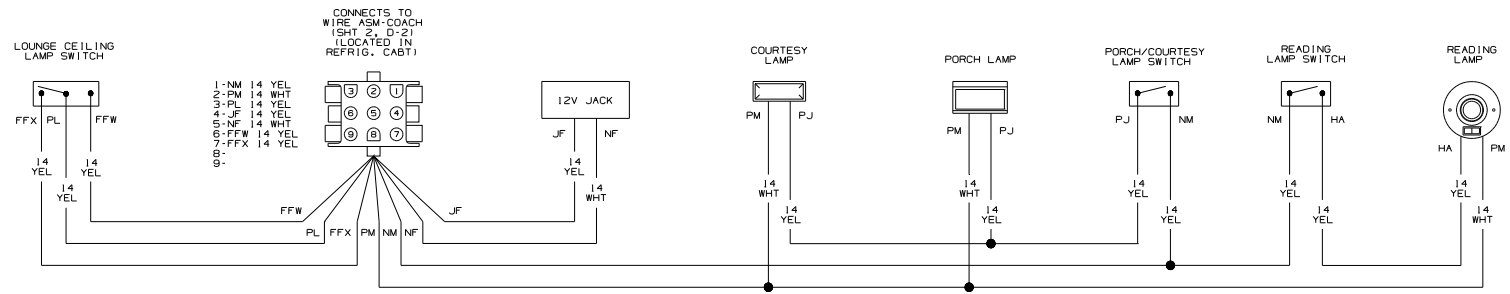

WIRING DIAGRAM-SIDEWALL, RIGHT  
(WIRE ASM 139620)

FIRST USED		02 P36GD	
DO NOT SCALE DRAWING			
TITLE: WIRING DIAGRAM-BODY, 12V			
SHEET	4	PART NO	139437



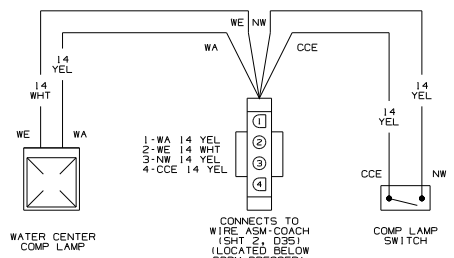

WIRING DIAGRAM-COMP, LAMPS  
(WIRE ASM 140654)

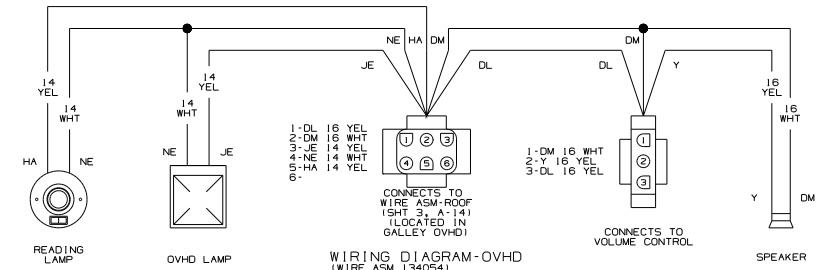

WIRING DIAGRAM-OVHD  
(WIRE ASM 134054)

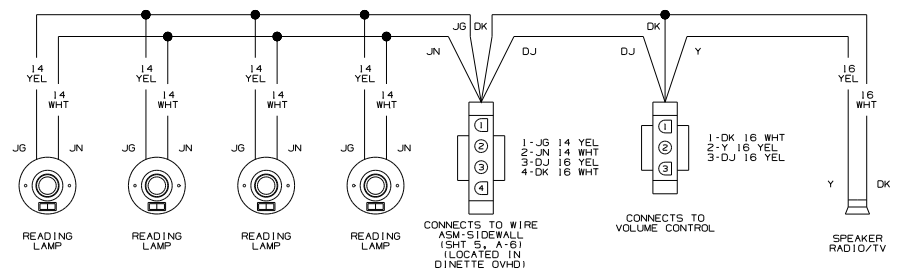

WIRING DIAGRAM-OVHD, LEFT  
(WIRE ASM 132424-04)

FIRST USED	02 P36GD
DO NOT SCALE DRAWING	
TITLE:	WIRING DIAGRAM-BODY, 12V
SHEET 6	PART NO 139437

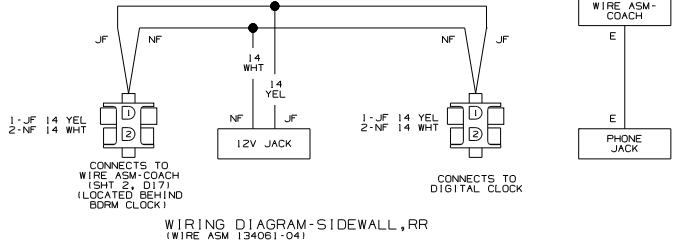

WIRING DIAGRAM-SIDEWALL, RR  
(WIRE ASM 134061-04)

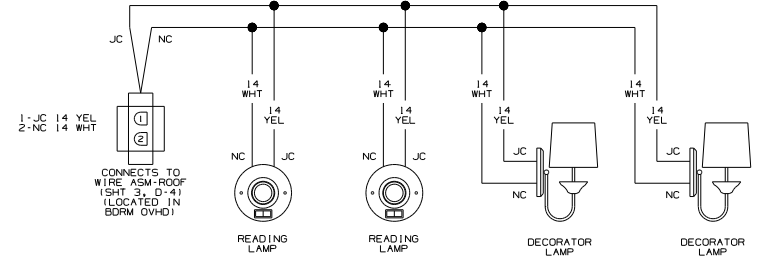

WIRING DIAGRAM-OVHD  
(WIRE ASM 133231-02)

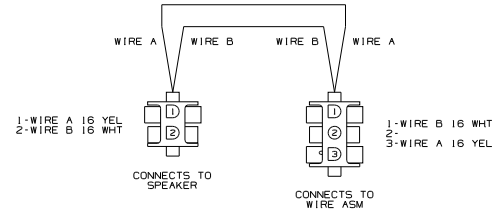

WIRING DIAGRAM-SPEAKER, ADAPTER  
(WIRE ASM 133817-02)

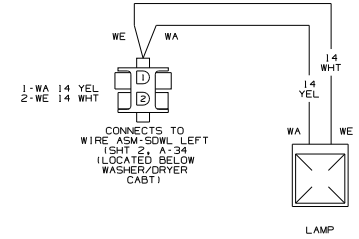

WIRING DIAGRAM-EXTERIOR SERVICE LAMP  
(WIRE ASM 77093-12)

NOTES:

FIRST USED	02 P36GD
DO NOT SCALE DRAWING	
TITLE:	WIRING DIAGRAM-BODY, 12V
SHEET	7
PART NO	139437

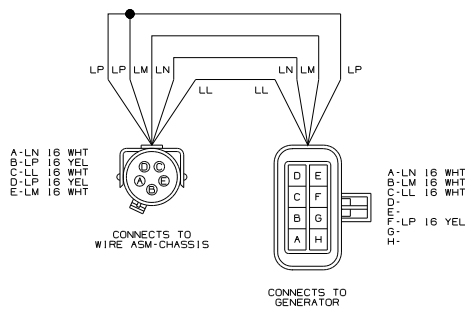

WIRING DIAGRAM-GEN, ADAPTER, LP  
(WIRE ASM 130332-01)

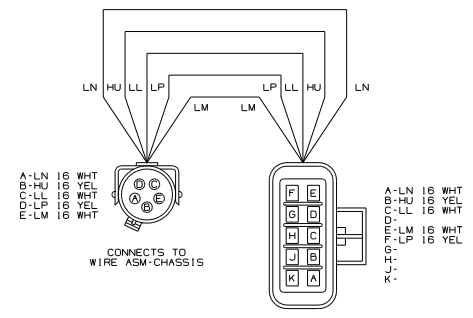

WIRING DIAGRAM-GEN, ADAPTER, LP  
(WIRE ASM 130332-02)

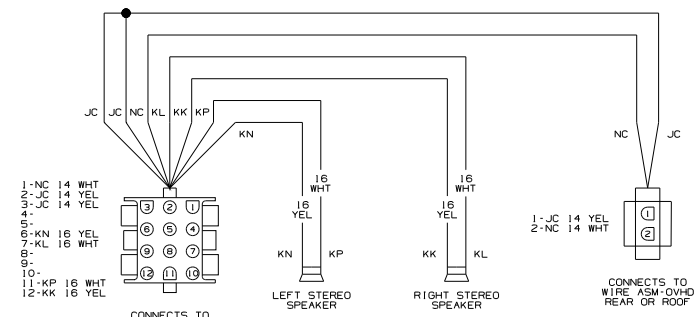

WIRING DIAGRAM-REAR STEREO  
(WIRE ASM 124336-01)

FIRST USED	02 P36GD	
TITLE:	DO NOT SCALE DRAWING	
	WIRING DIAGRAM-BODY, 12V	
SHEET 8	PART NO	139437