



DANGER

Danger of electrical shock, burns or death. Always remove all power sources before attempting any repair, service or diagnostic work. Power can be present from shore power, generator, inverter or battery. All power sources must be disabled and secured before performing any service.



CAUTION

If you lack the skills, tools or equipment to perform diagnostic or repair work leave such work to an authorized Winnebago Industries dealer or other qualified shop.

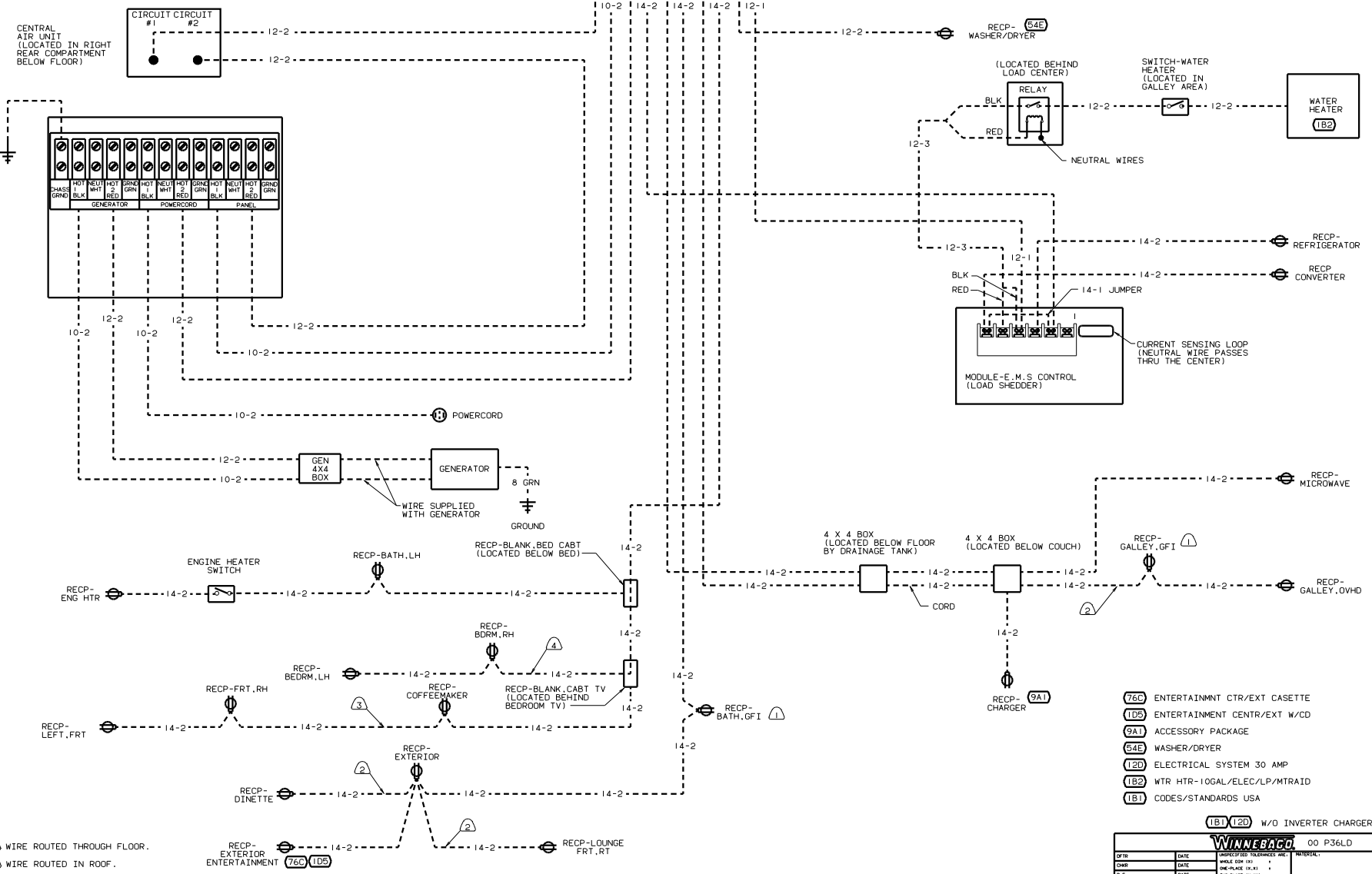
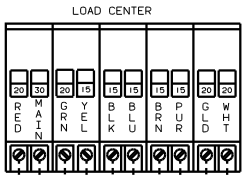

- ④ WIRE ROUTED THROUGH FLOOR.
- ③ WIRE ROUTED IN ROOF.
- ② WIRE ROUTED IN SIDEWALL.
- ① ALL OUTLETS DOWN STREAM AND INCLUDING THIS OUTLET ARE GROUND FAULT INTERRUPT PROTECTED.

- (76C) ENTERTAINMENT CTR/EXT CASSETTE
- (1D5) ENTERTAINMENT CENTR/EXT W/CD
- (9A1) ACCESSORY PACKAGE
- (64E) WASHER/DRYER
- (12D) ELECTRICAL SYSTEM 30 AMP
- (1B2) WTR HTR-10GAL/ELEC/LP/MTRAIID
- (1B1) CODES/STANDARDS USA

(1B1) (12D) W/O INVERTER CHARGER

WINNEBAGO		00 P36LD
DATE	UNDESIGNED DIMENSIONS ARE:	MATERIAL:
DATE	WHOLE OR 1/2"	
DATE	ONE-PLACE (1/8")	
DATE	TWO-PLACE (1/8")	
DATE	ANGLE	
DATE	INDIC. W/ANGLE	
DATE	PROJECTION	
DATE		
TITLE: WIRING DIAGRAM-BODY 110V SHEET 1 OF 8 133818		

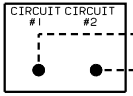
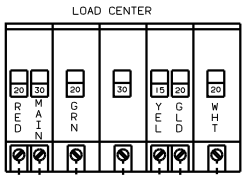

CENTRAL AIR UNIT (LOCATED IN RIGHT REAR COMPARTMENT BELOW FLOOR)

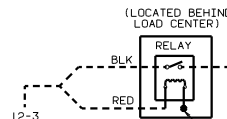
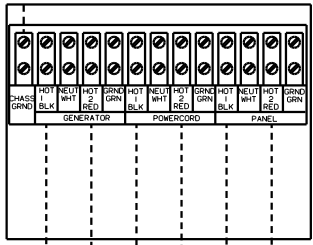

SWITCH-WATER HEATER (LOCATED IN GALLEY AREA)

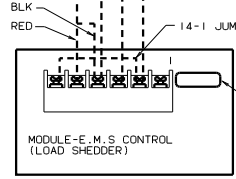
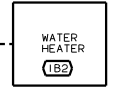

INVERTER BREAKER PANEL

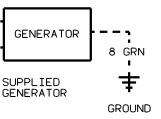
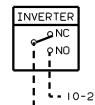
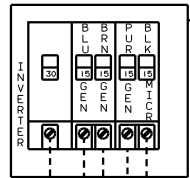

WIRE SUPPLIED WITH GENERATOR

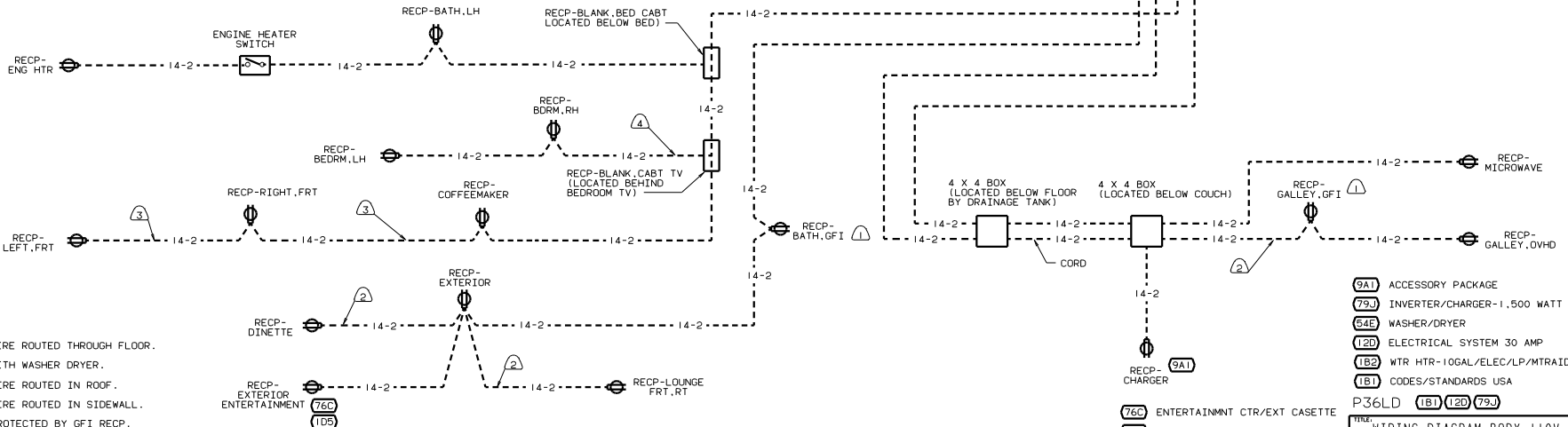

- NOTES:
- ③ WIRE ROUTED THROUGH FLOOR.
 - ④ WITH WASHER DRYER.
 - ③ WIRE ROUTED IN ROOF.
 - ② WIRE ROUTED IN SIDEWALL.
 - ⚠ PROTECTED BY GFI RECP.

- ⑨A1 ACCESSORY PACKAGE
- ⑦9J INVERTER/CHARGER-1,500 WATT
- ⑤4E WASHER/DRYER
- ①2D ELECTRICAL SYSTEM 30 AMP
- ①82 WTR HTR-10GAL/ELEC/LP/MTR/ITRAID
- ①B1 CODES/STANDARDS USA
- P36LD ①B1 ①2D ⑦9J
- ⑦6C ENTERTAINMENT CTR/EXT CASSETTE
- ①B5 ENTERTAINMENT CTR/EXT W/CD

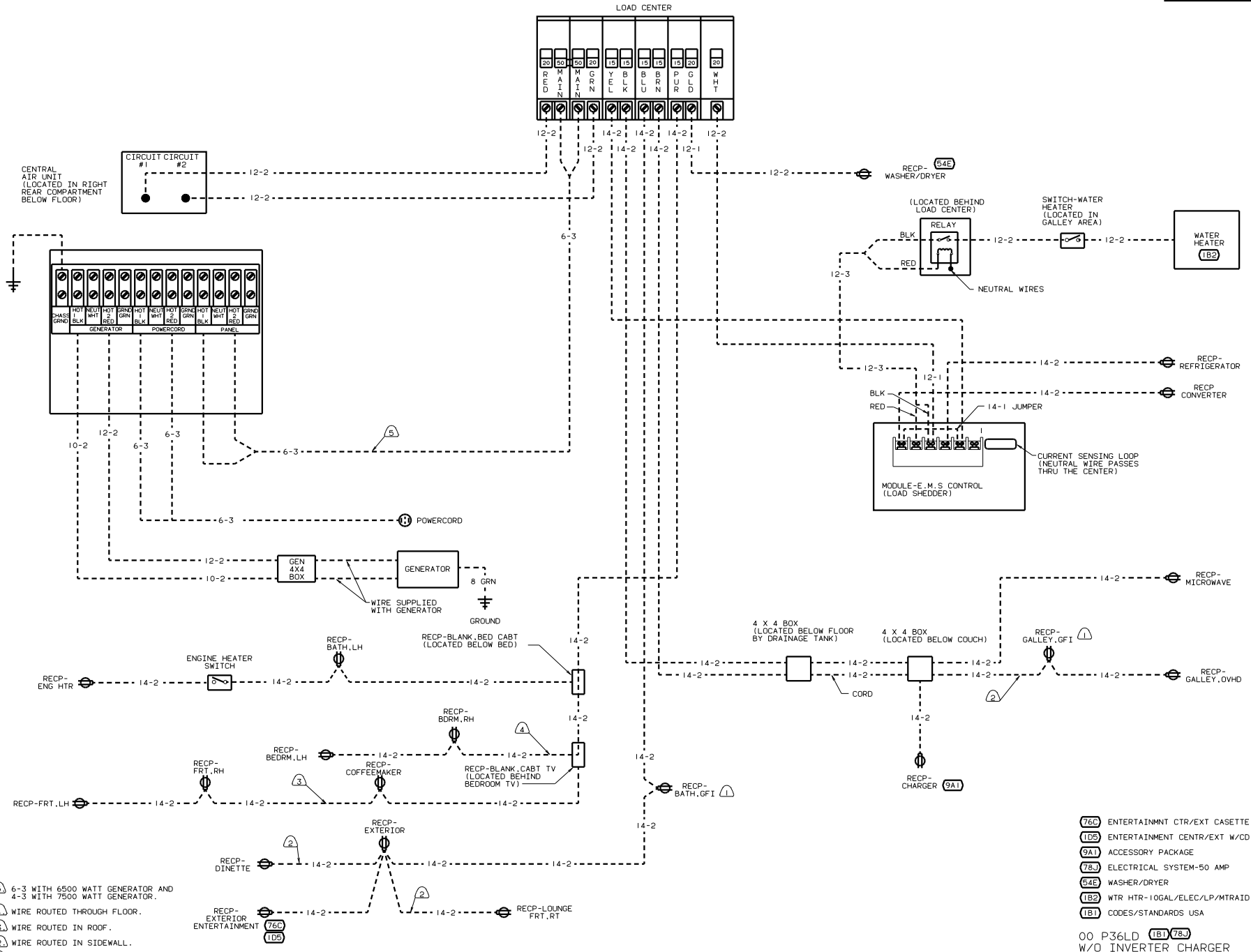

(5) 6-3 WITH 6500 WATT GENERATOR AND 4-3 WITH 7500 WATT GENERATOR.
 (4) WIRE ROUTED THROUGH FLOOR.
 (3) WIRE ROUTED IN ROOF.
 (2) WIRE ROUTED IN SIDEWALL.
 (1) ALL OUTLETS DOWN STREAM AND INCLUDING THIS OUTLET ARE GROUND FAULT INTERRUPT PROTECTED.

- (76C) ENTERTAINMNT CTR/EXT CASSETTE
- (105) ENTERTAINMENT CENTR/EXT W/CD
- (9A1) ACCESSORY PACKAGE
- (78J) ELECTRICAL SYSTEM-50 AMP
- (54E) WASHER/DRYER
- (1B2) WTR HTR-10GAL/ELEC/LP/MTR/TRAID
- (1B1) CODES/STANDARDS USA

00 P36LD (1B1)(78J)
 W/O INVERTER CHARGER

TITLE: WIRING DIAGRAM-BODY 110V	
NO. OF SHEETS	TOTAL SHEETS
3 OF 8	8
133818	

NOTES:

LOAD CENTER

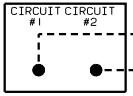
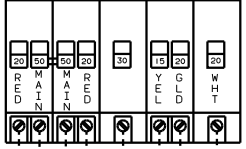

CENTRAL AIR UNIT (LOCATED IN RIGHT REAR COMPARTMENT BELOW FLOOR)

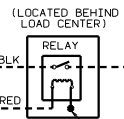
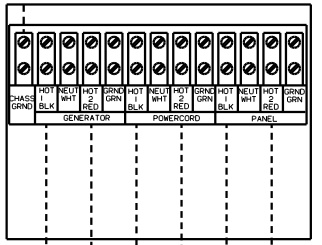

SWITCH-WATER HEATER (LOCATED IN GALLEY AREA)

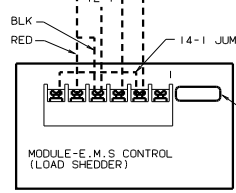

INVERTER BREAKER PANEL

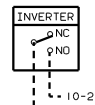
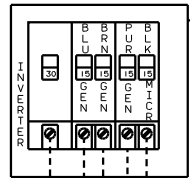

- ① 6-3 WITH 6500 WATT GENERATOR AND 4-3 WITH 7500 WATT GENERATOR.
- ② WIRE ROUTED THROUGH FLOOR.
- ③ WITH WASHER DRYER.
- ④ WIRE ROUTED IN ROOF.
- ⑤ WIRE ROUTED IN SIDEWALL.
- ⑥ PROTECTED BY GFI RECP.

- ⑨A1 ACCESSORY PACKAGE
- ⑦9J INVERTER/CHARGER-1,500 WATT
- ⑦8J ELECTRICAL SYSTEM-50 AMP
- ⑤4E WASHER/DRYER
- ①D5 ENTERTAINMENT CENTR/EXT W/COD
- ①B2 WTR HTR-10GAL/ELEC/LP/MTR/RAID
- ①B1 CODES/STANDARDS USA

NOTES:

⑦6C ENTERTAINMENT CTR/EXT CASSETTE

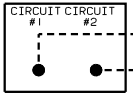
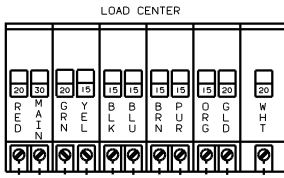

CENTRAL AIR UNIT (LOCATED IN RIGHT REAR COMPARTMENT BELOW FLOOR)

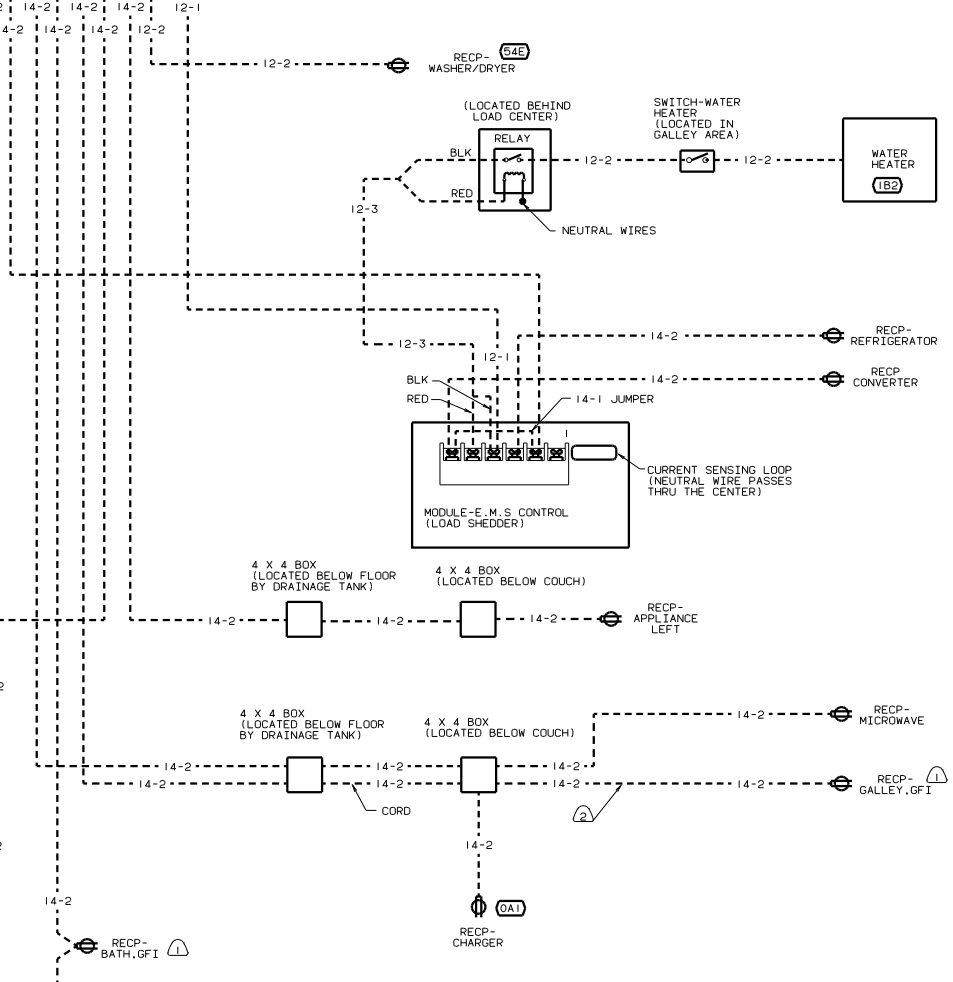
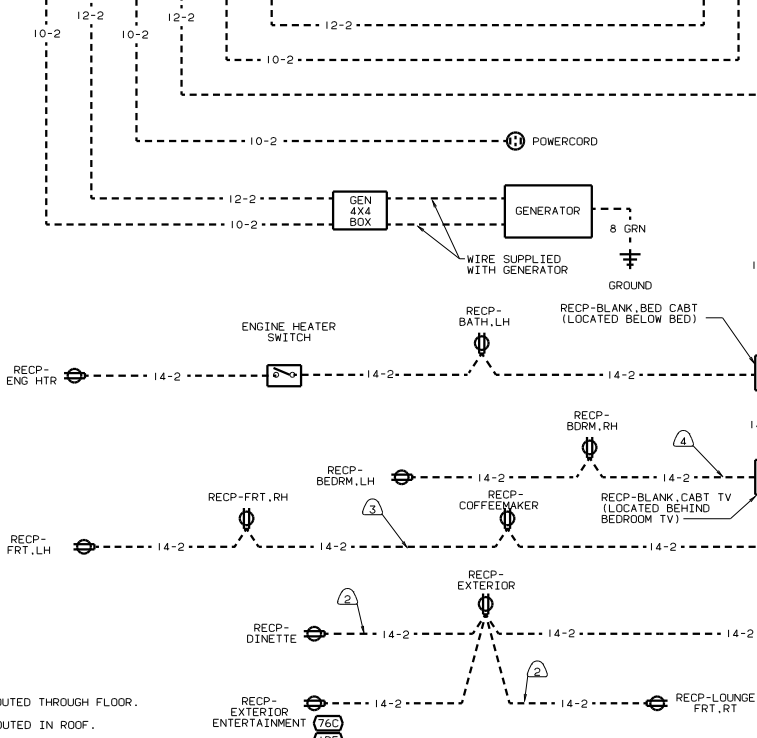
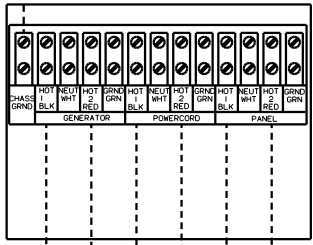

- (9A1) ACCESSORY PACKAGE
- (76C) ENTERTAINMENT CTR/EXT CASSETTE
- (54E) WASHER/DRYER
- (26S) CODES/STANDARDS-CSA/CMVSS
- (12D) ELECTRICAL SYSTEM 30 AMP
- (1D5) ENTERTAINMENT CENTR/EXT W/CD
- (1B2) WTR HTR-10GAL/ELEC/LP/MTR/RAID

NOTES:
 (4) WIRE ROUTED THROUGH FLOOR.
 (3) WIRE ROUTED IN ROOF.
 (2) WIRE ROUTED IN SIDEWALL.
 (1) ALL OUTLETS DOWN STREAM AND INCLUDING THIS OUTLET ARE GROUND FAULT INTERRUPT PROTECTED.

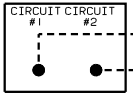
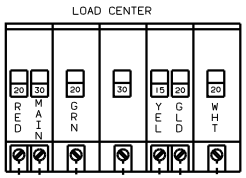

CENTRAL AIR UNIT
(LOCATED IN RIGHT REAR COMPARTMENT BELOW FLOOR)

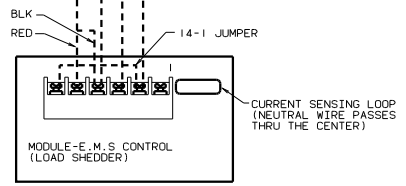
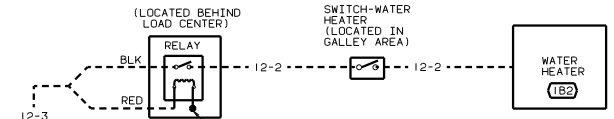
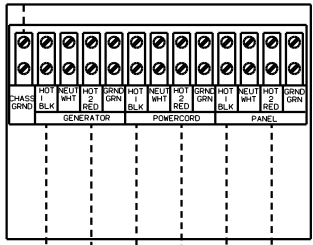

INVERTER BREAKER PANEL

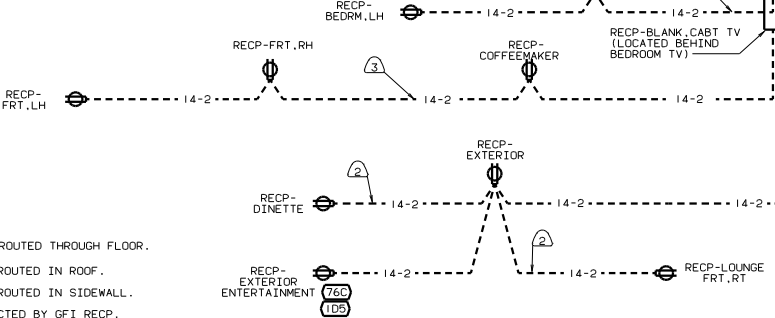
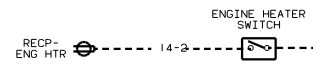
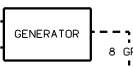
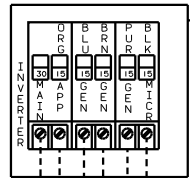

- NOTES:
- (4) WIRE ROUTED THROUGH FLOOR.
 - (3) WIRE ROUTED IN ROOF.
 - (2) WIRE ROUTED IN SIDEWALL.
 - (1) PROTECTED BY GFI RECP.

- (79J) INVERTER/CHARGER-1,500 WATT
- (76C) ENTERTAINMENT CTR/EXT CASSETTE
- (265) CODES/STANDARDS-CSA/CMVSS
- (54E) WASHER/DRYER
- (12D) ELECTRICAL SYSTEM 30 AMP
- (105) ENTERTAINMENT CENTR/EXT W/CD
- (1B2) WTR HTR-10GAL/ELEC/LP/MTR/1RD

LOAD CENTER

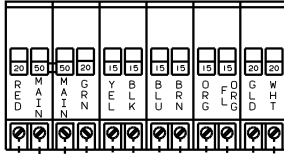

12-2 12-2 14-2 14-2 14-2 14-2 14-2 14-2 14-2 14-2 12-1

CENTRAL AIR UNIT (LOCATED IN RIGHT REAR COMPARTMENT BELOW FLOOR)

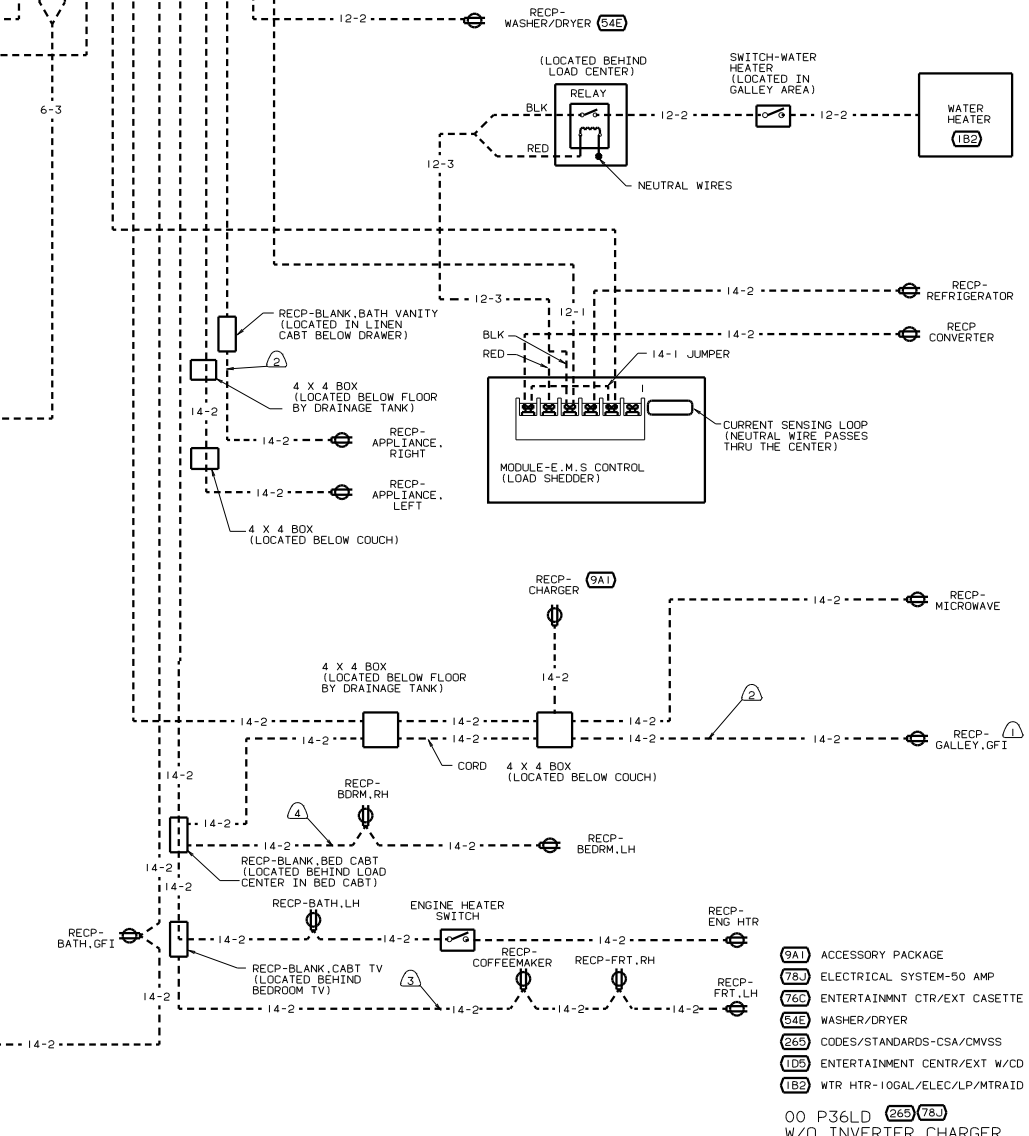
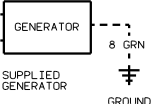
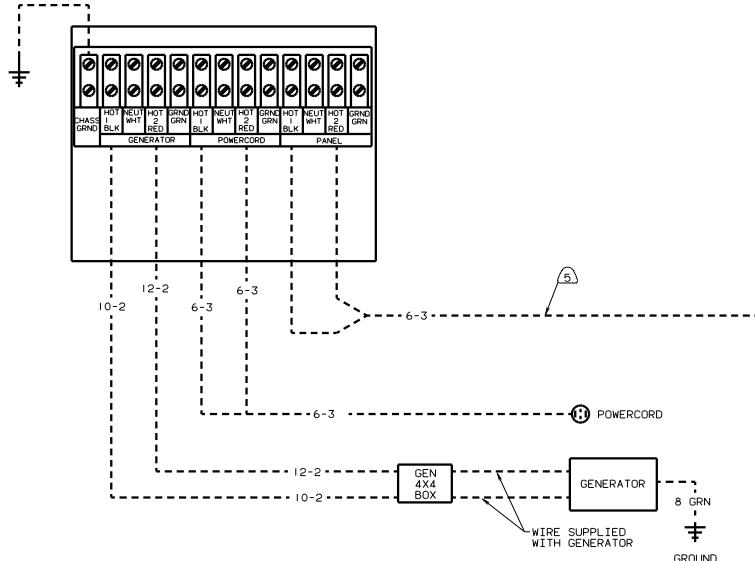
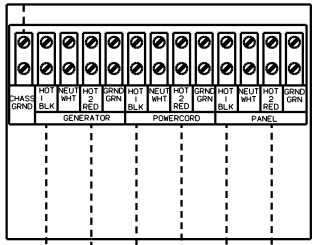
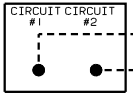

- ⑤ 6-3 WITH 6500 WATT GENERATOR AND 4-3 WITH 7500 WATT GENERATOR.
- ④ WIRE ROUTED THROUGH FLOOR.
- ③ WIRE ROUTED IN ROOF.
- ② WIRE ROUTED IN SIDEWALL.
- ① ALL OUTLETS DOWN STREAM AND INCLUDING THIS OUTLET ARE GROUND FAULT INTERRUPT PROTECTED.

- 9A1 ACCESSORY PACKAGE
- 78J ELECTRICAL SYSTEM-50 AMP
- 76C ENTERTAINMENT CTR/EXT CASSETTE
- 265 CODES/STANDARDS-CSA/CMVSS
- 105 ENTERTAINMENT CENTR/EXT W/CD
- 1B2 WTR HTR-10GAL/ELEC/LP/MTR/AID

00 P36LD (265) (78J) W/O INVERTER CHARGER

DATE: _____

WIRING DIAGRAM-BODY 110V

NO. OF SHEETS: 8 SHEET NO. 7 OF 8

FIG. NO. 133818

NOTES:

LOAD CENTER

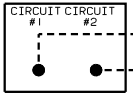
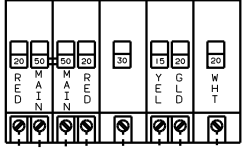

CENTRAL AIR UNIT (LOCATED IN RIGHT REAR COMPARTMENT BELOW FLOOR)

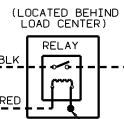
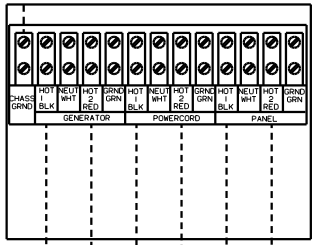

SWITCH-WATER HEATER (LOCATED IN GALLEY AREA)

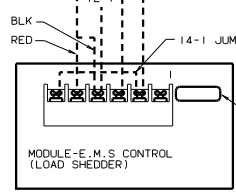

INVERTER BREAKER PANEL

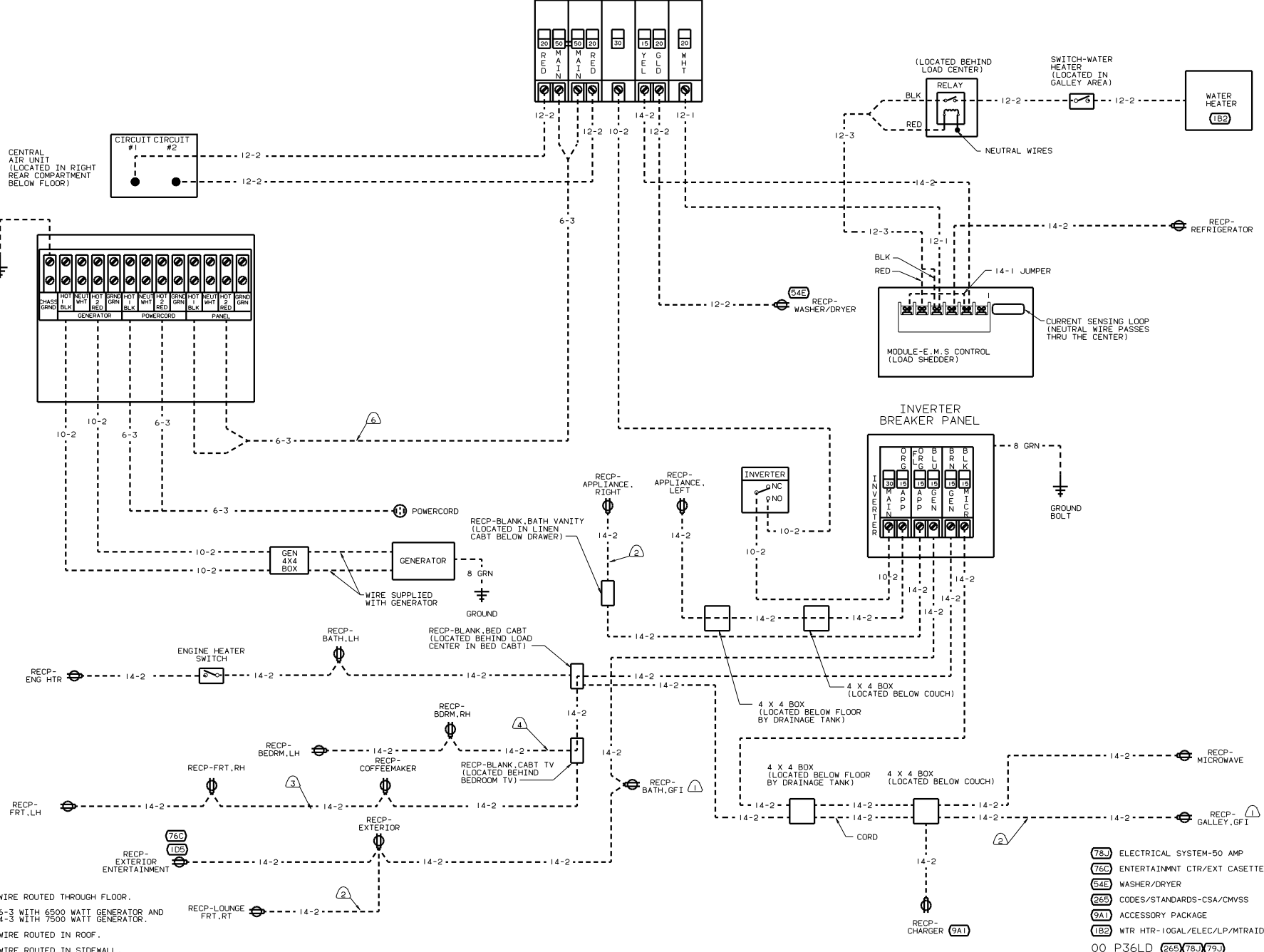
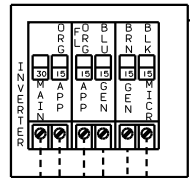

- (3) WIRE ROUTED THROUGH FLOOR.
- (4) 6-3 WITH 6500 WATT GENERATOR AND 4-3 WITH 7500 WATT GENERATOR.
- (5) WIRE ROUTED IN ROOF.
- (2) WIRE ROUTED IN SIDEWALL.
- (1) PROTECTED BY GFI RECP.

NOTES:

- (78J) ELECTRICAL SYSTEM-50 AMP
- (76C) ENTERTAINMENT CTR/EXT CASSETTE
- (54E) WASHER/DRYER
- (265) CODES/STANDARDS-CSA/CMVSS
- (9A1) ACCESSORY PACKAGE
- (1B2) WTR HTR-10GAL/ELEC/LP/MTRAITD

- (79J) INVERTER/CHARGER-1.500 WATT
- (1D5) ENTERTAINMENT CENTR/EXT W/CD