



DANGER

Danger of electrical shock, burns or death. Always remove all power sources before attempting any repair, service or diagnostic work. Power can be present from shore power, generator, inverter or battery. All power sources must be disabled and secured before performing any service.



CAUTION

If you lack the skills, tools or equipment to perform diagnostic or repair work leave such work to an authorized Winnebago Industries dealer or other qualified shop.

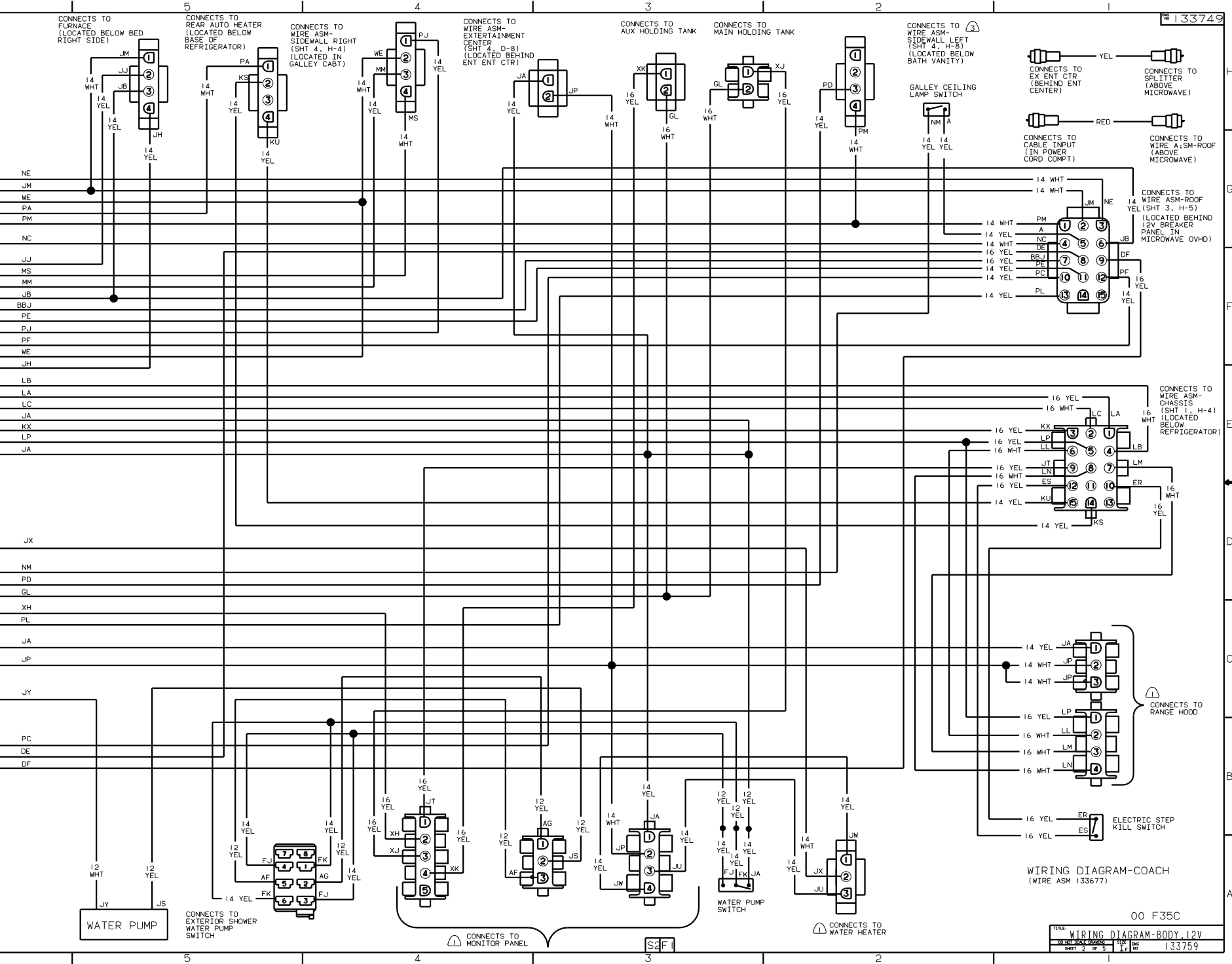

CONNECTS TO FURNACE (LOCATED BELOW BED RIGHT SIDE)

CONNECTS TO REAR AUTO HEATER (LOCATED BELOW BASE OF REFRIGERATOR)

CONNECTS TO WIRE ASM-SIDEWALL RIGHT (SHT 4, H-4) (LOCATED IN GALLEY CABT)

CONNECTS TO WIRE ASM-EXTERMINATION CENTER (SHT 4, D-8) (LOCATED BEHIND ENT ENT CTR)

CONNECTS TO AUX HOLDING TANK

CONNECTS TO MAIN HOLDING TANK

CONNECTS TO WIRE ASM-SIDEWALL LEFT (SHT 4, H-8) (LOCATED BELOW BATH VANITY)

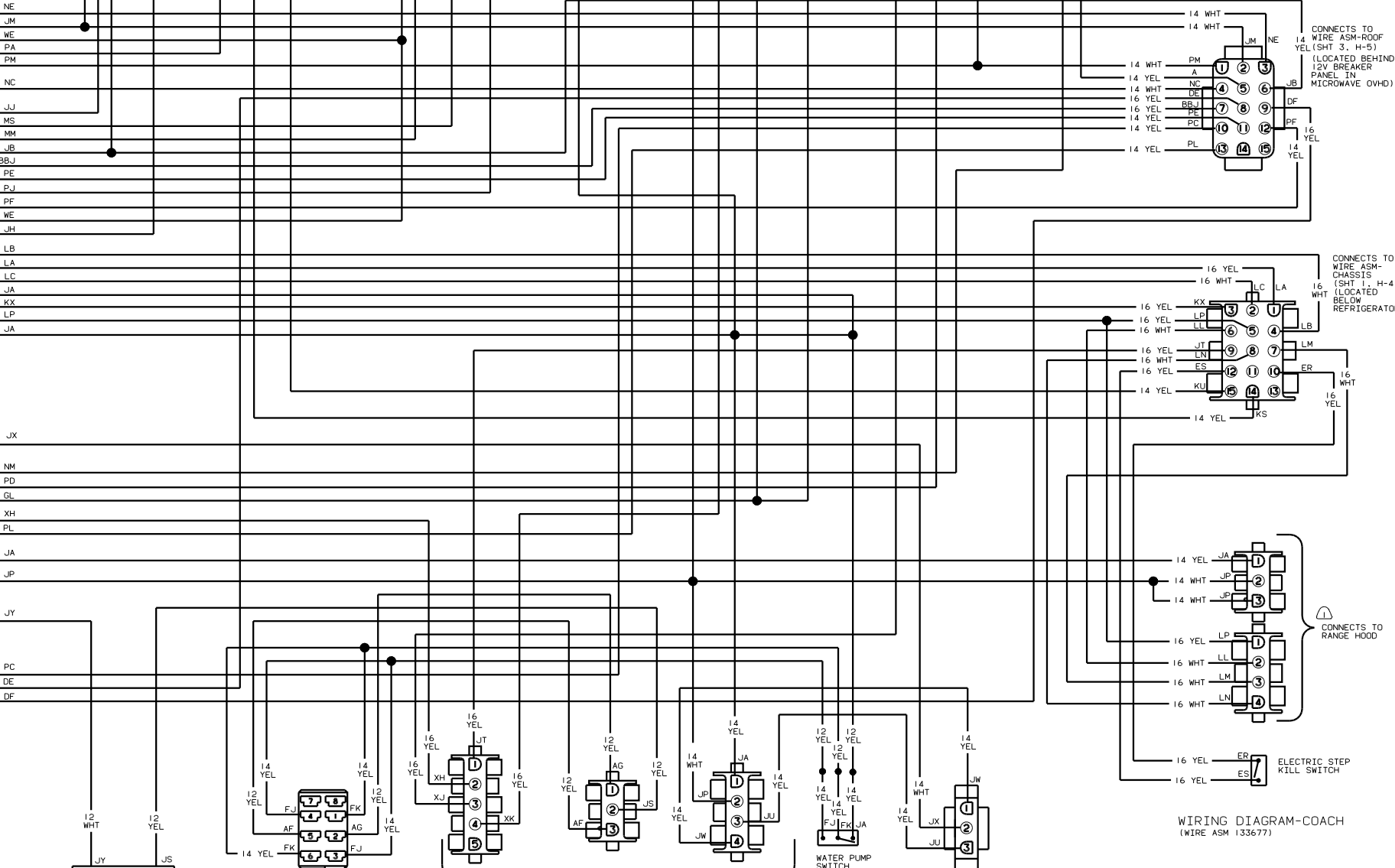
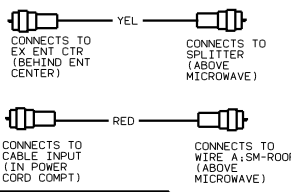

WIRING DIAGRAM-COACH (WIRE ASM 133677)

00 F35C

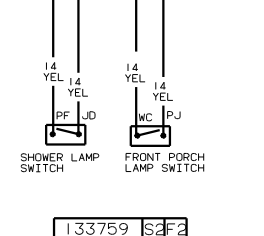
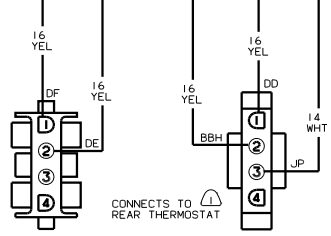
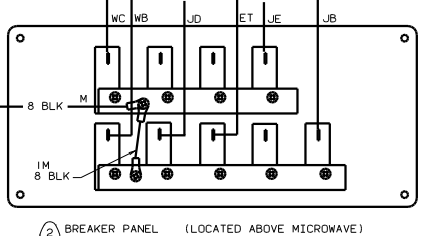
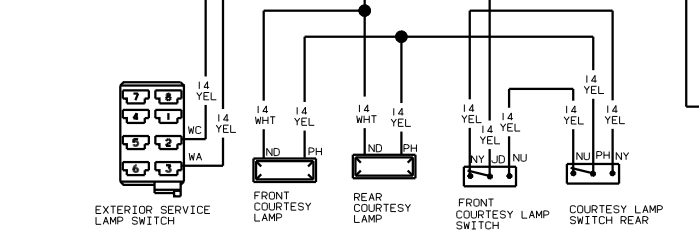
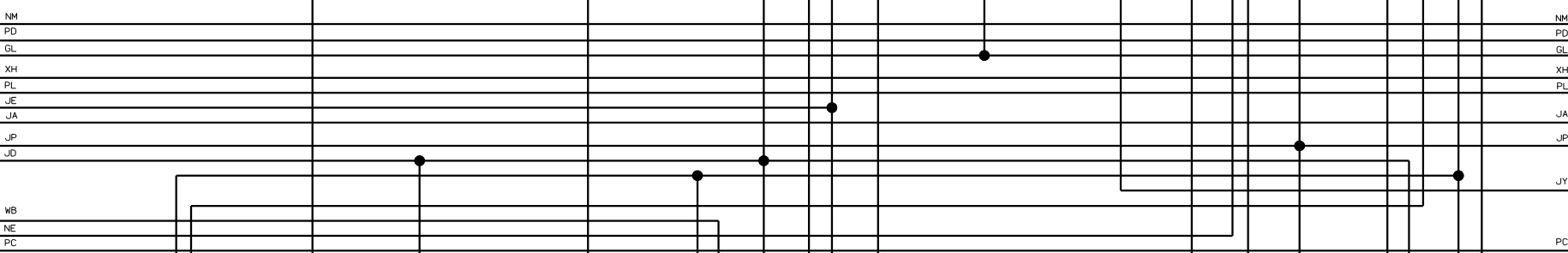
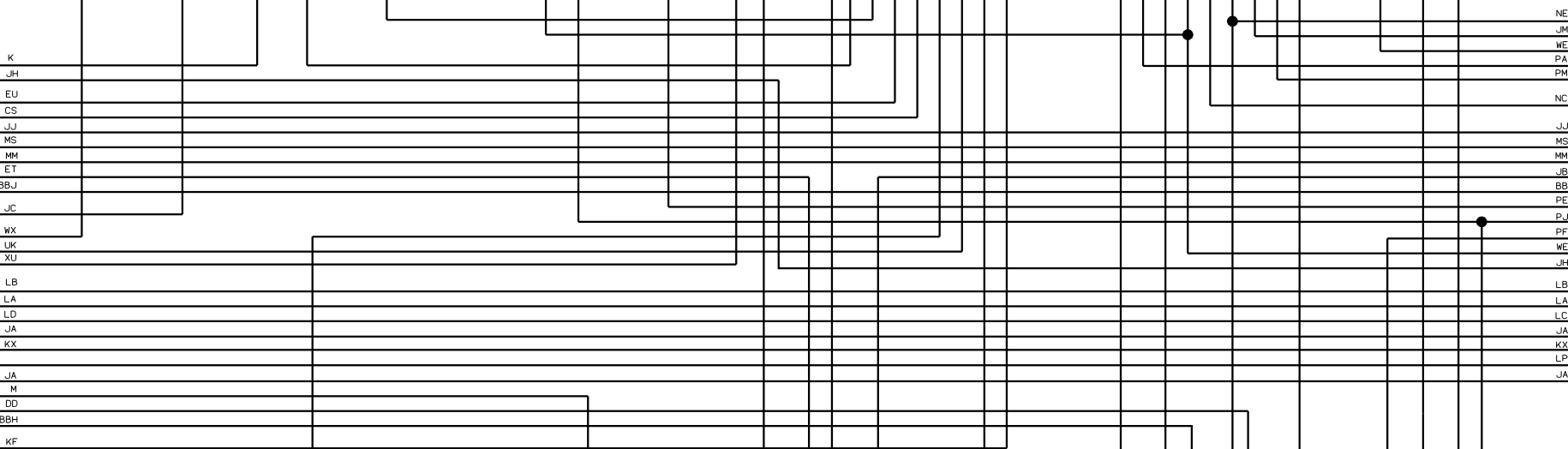
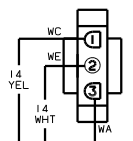
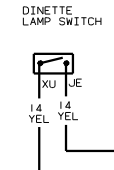
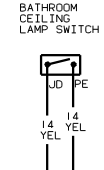
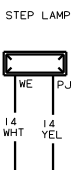
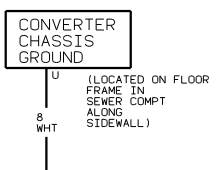
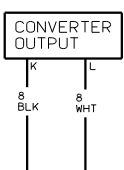
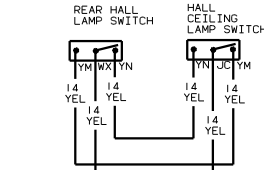
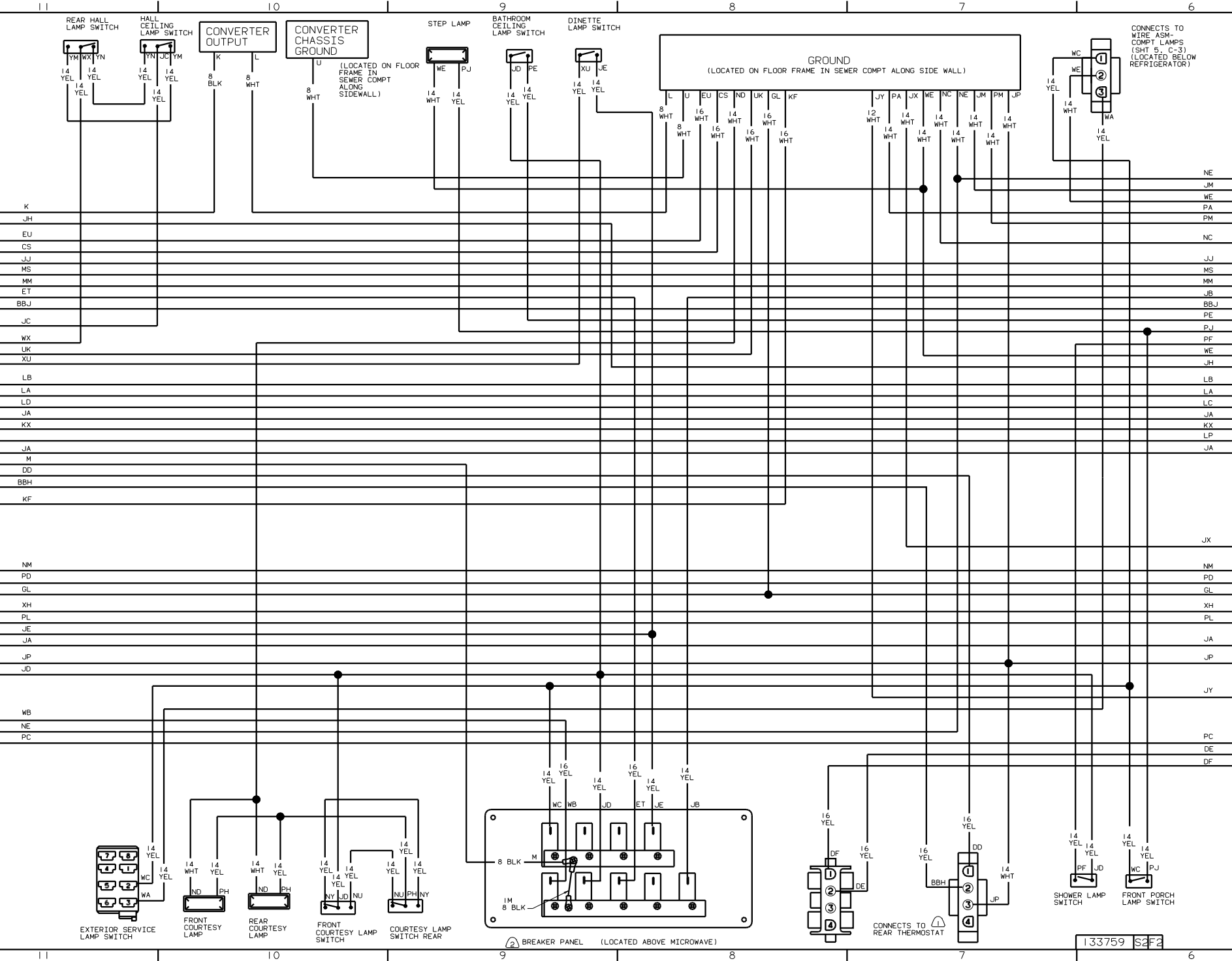

133759 S2F2

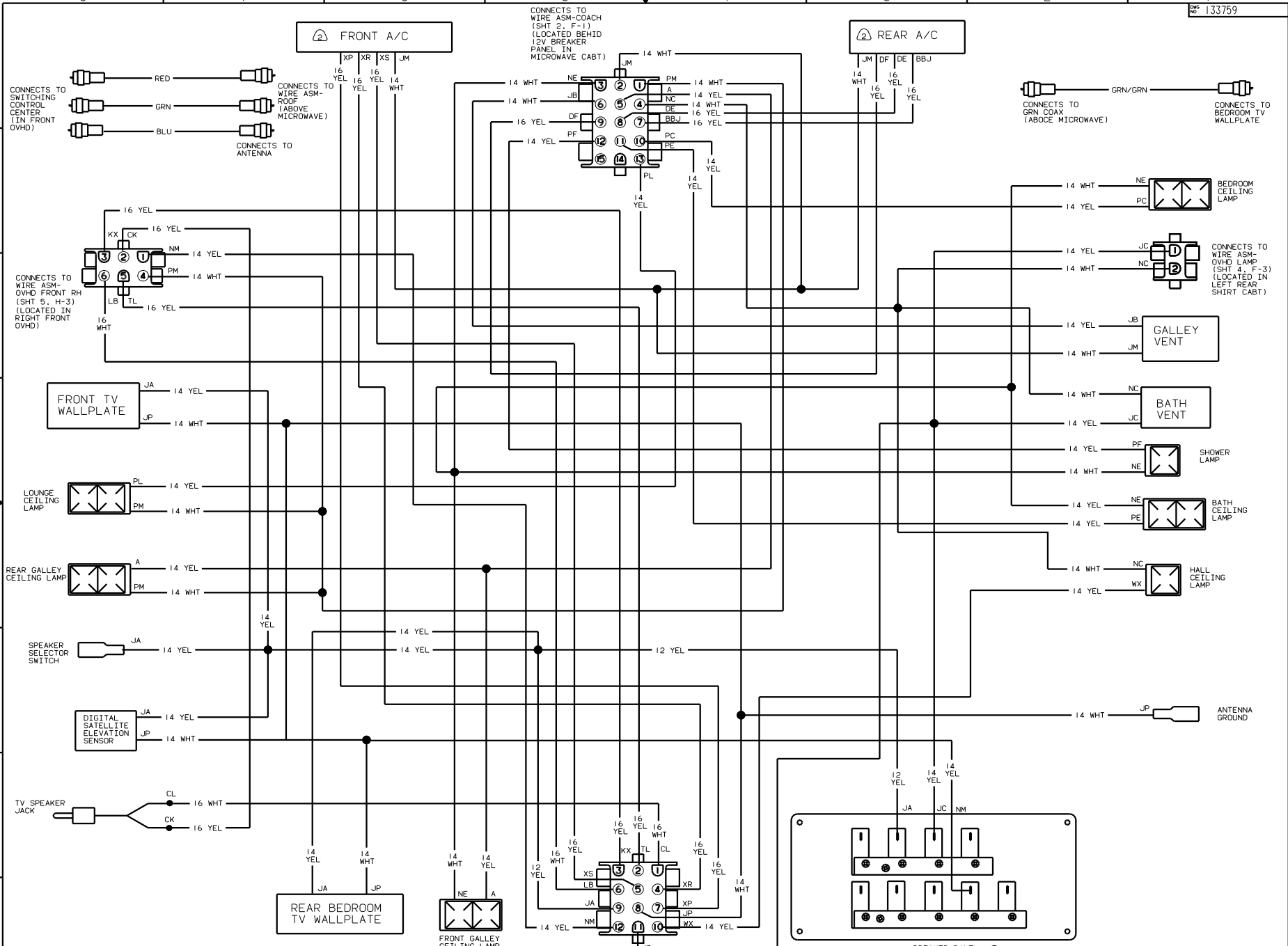

NOTES:
 ② SEE MANUFACTURER'S DIAGRAM FOR ADDITIONAL INFORMATION.
 ① SEE SHT 2 FOR ADDITIONAL INFORMATION.

WIRING DIAGRAM ROOF
 (WIRE ASM 130599)

00 F35C

TITLE: WIRING DIAGRAM-BODY_12V	
NO. OF SHEETS: 5	SHEET NO: 3
DATE: 1/6	REV: 1
133759	

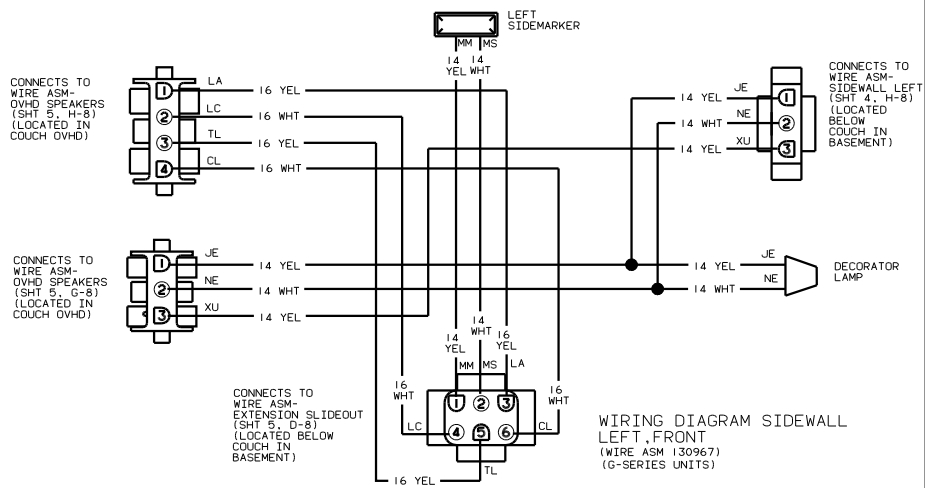
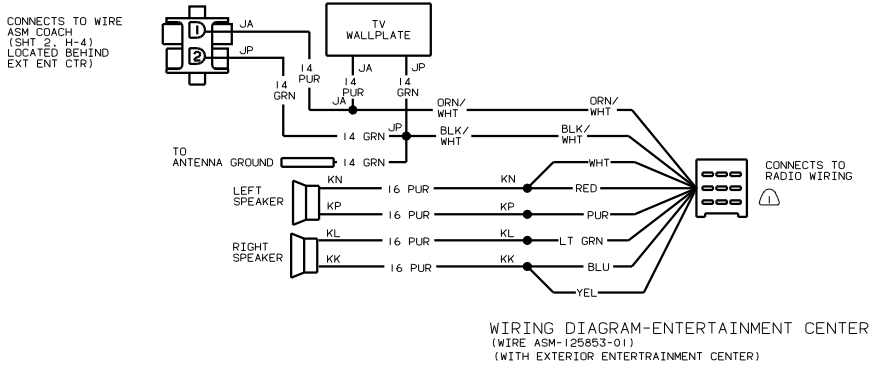
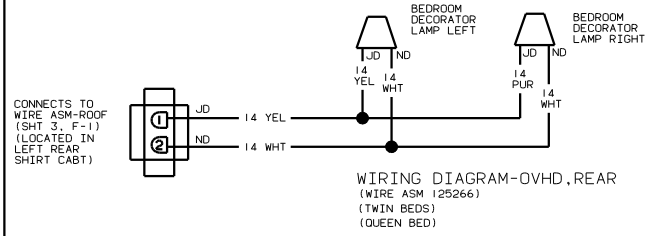
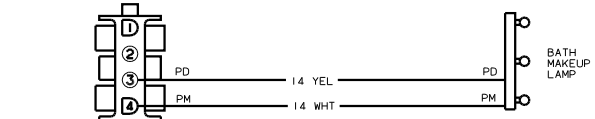

1) SEE MANUFACTURER'S DIAGRAM FOR ADDITIONAL INFORMATION.



WIRING DIAGRAM OVHD SPEAKER
(WIRE ASM 128409)

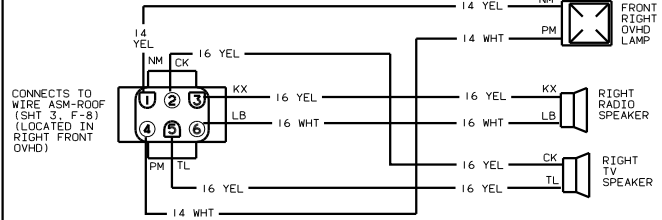
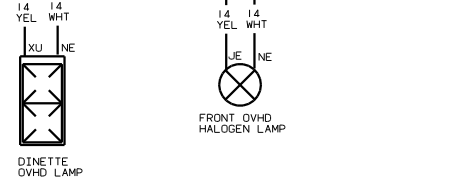

WIRING DIAGRAM OVHD, FRONT RH
(WIRE ASM 129825)



WIRING DIAGRAM SIDEWALL, RIGHT
(WIRE ASM 126460)

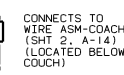
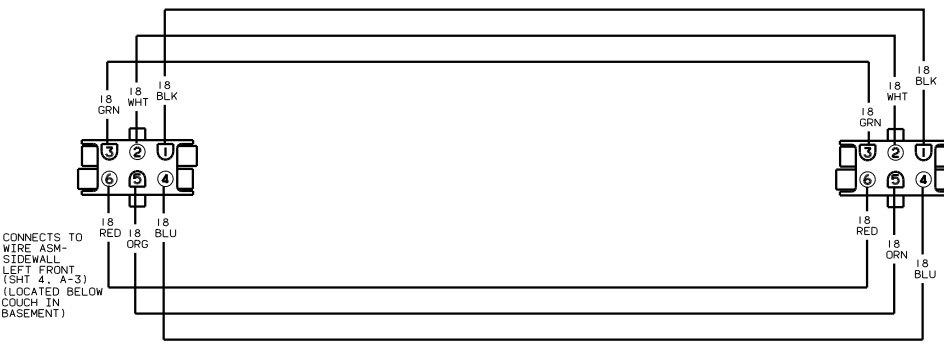
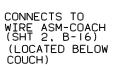
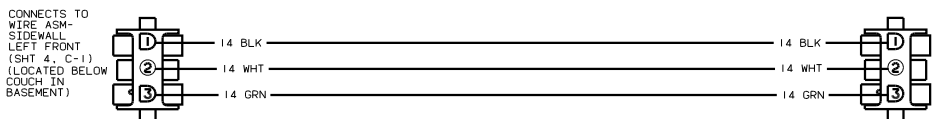

WIRING DIAGRM EXTENSION, SLIDEOUT
(WIRE ASM 127973)

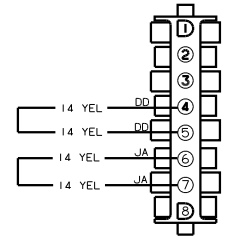

WIRING DIAGRAM JUMPER
(WIRE ASM 130106)
(W/O ENERGY MANAGEMENT SYSTEM)

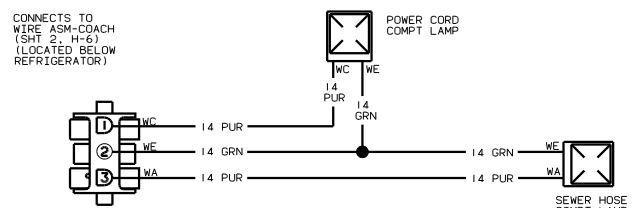

WIRING DIAGRAM COMPT LAMPS
(WIRE ASM 127793-01)

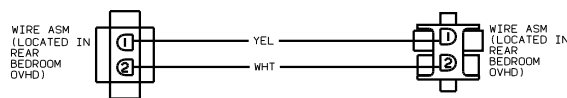

WIRING DIAGRAM OVHD, REAR EXT
(WIRE ASM 130858)
(TWIN BEDS)