



DANGER

Danger of electrical shock, burns or death. Always remove all power sources before attempting any repair, service or diagnostic work. Power can be present from shore power, generator, inverter or battery. All power sources must be disabled and secured before performing any service.



CAUTION

If you lack the skills, tools or equipment to perform diagnostic or repair work leave such work to an authorized Winnebago Industries dealer or other qualified shop.

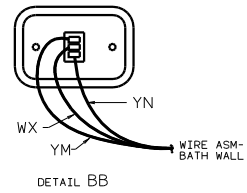
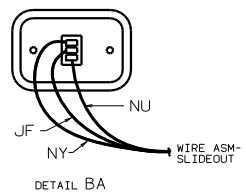
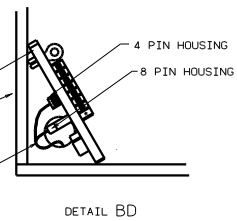
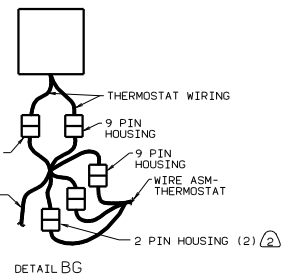
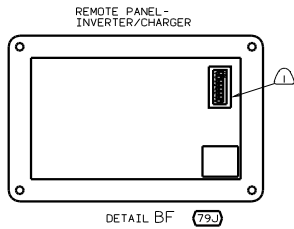
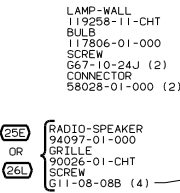
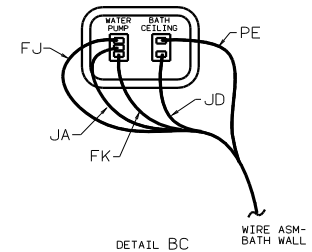
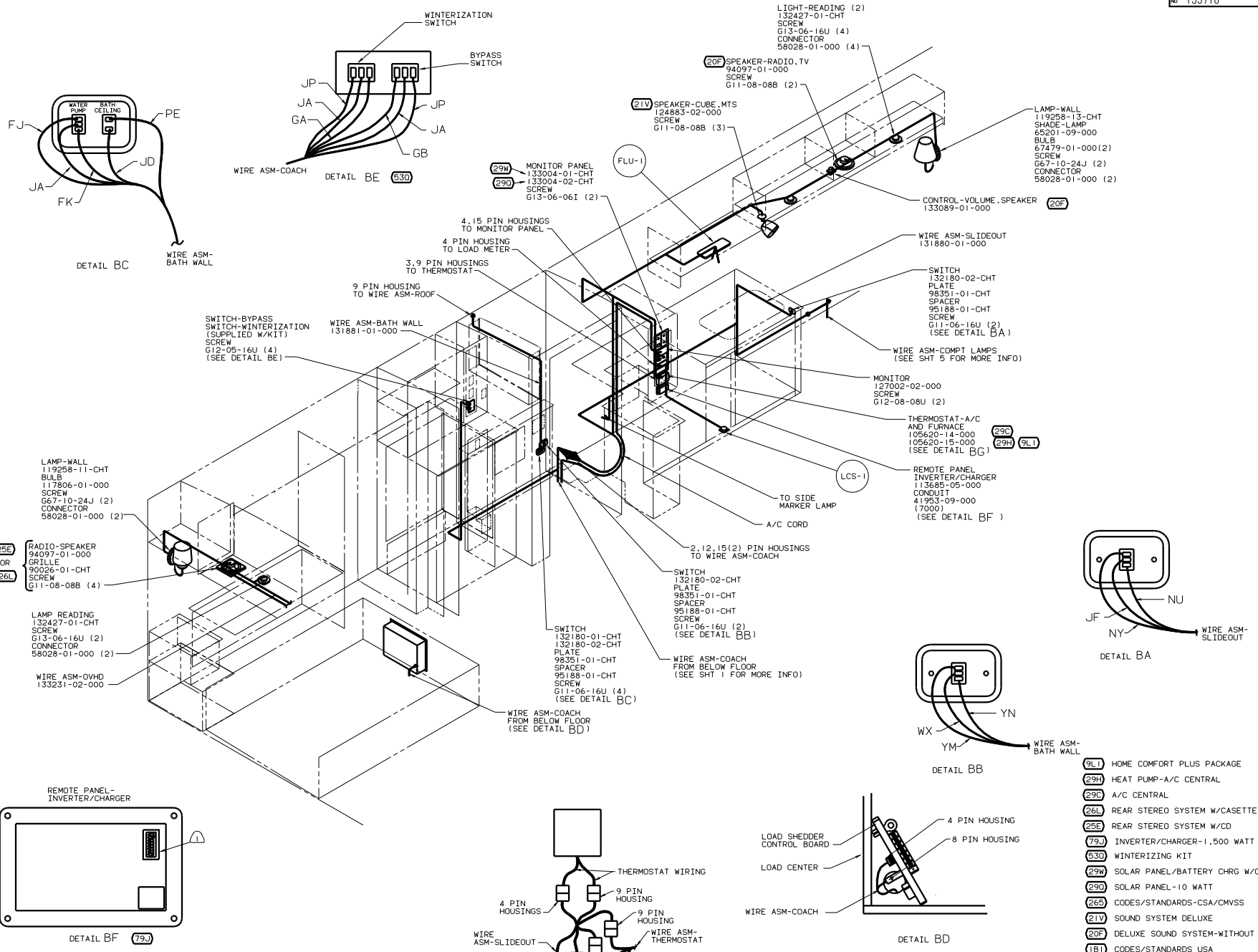

NOTES:
 ② WITHOUT (29H) PLUG THE TWO, TWO PIN HOUSINGS TOGETHER ON WIRE ASM-SLIDEOUT.
 ① DIP SWITCHES MUST BE SET AS FOLLOWS: 1 OFF, 2 OFF, 3 OFF, 4 OFF, 5 OFF, 6 OFF, 7 OFF, 8 ON.

FOR ELECTRICAL TORQUE SPECIFICATIONS SEE DWD NO. 128783-01-000

- (9L1) HOME COMFORT PLUS PACKAGE
- (29H) HEAT PUMP-A/C CENTRAL
- (29C) A/C CENTRAL
- (26L) REAR STEREO SYSTEM W/CASSETTE
- (26L) REAR STEREO SYSTEM W/CD
- (25E) INVERTER/CHARGER-1,500 WATT
- (530) WINTERIZING KIT
- (29H) SOLAR PANEL/BATTERY CHR9 W/O
- (29D) SOLAR PANEL-10 WATT
- (26S) CODES/STANDARDS-CSA/CMVSS
- (21V) SOUND SYSTEM DELUXE
- (20F) DELUXE SOUND SYSTEM-WITHOUT
- (1B1) CODES/STANDARDS USA

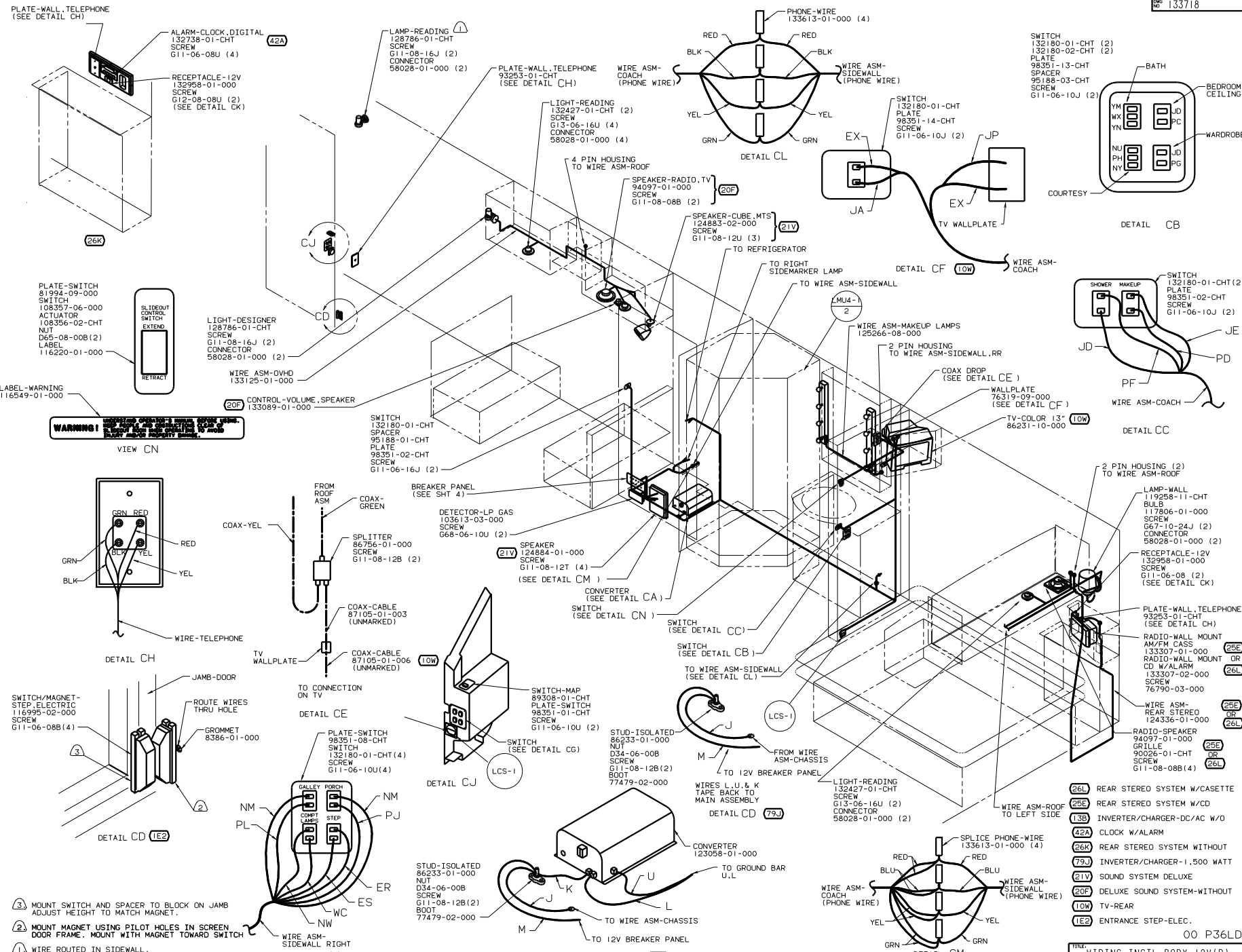

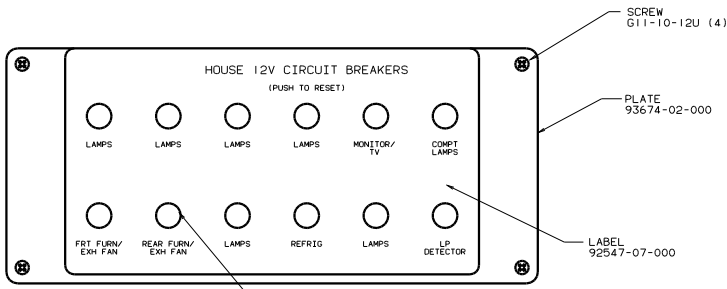

CIRCUIT BREAKER (FRONT VIEW)

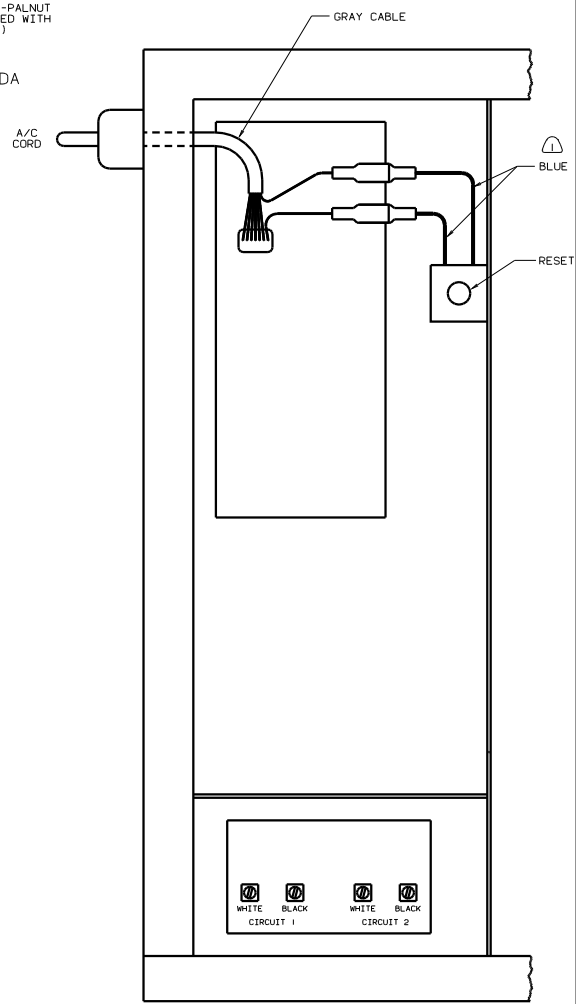
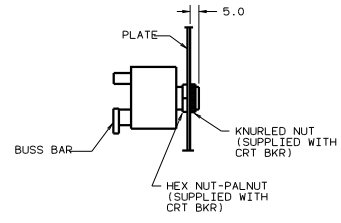

DETAIL DA-DA

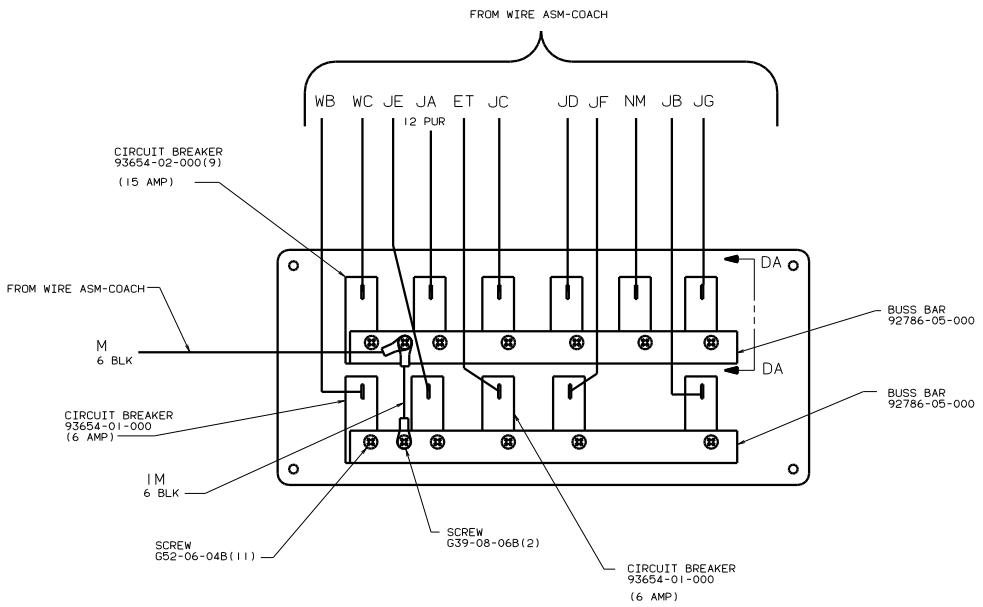

CIRCUIT BREAKER (BACK VIEW)

- (9L1) HOME COMFORT PLUS PACKAGE
- (29H) HEAT PUMP-A/C CENTRAL

NOTES:

CONNECT BLUE WIRES FROM RESET TO THE BLUE WIRES WITH SPADE TERMINALS ON A/C CORD WITH (29H) & (9L1) FEATURE.

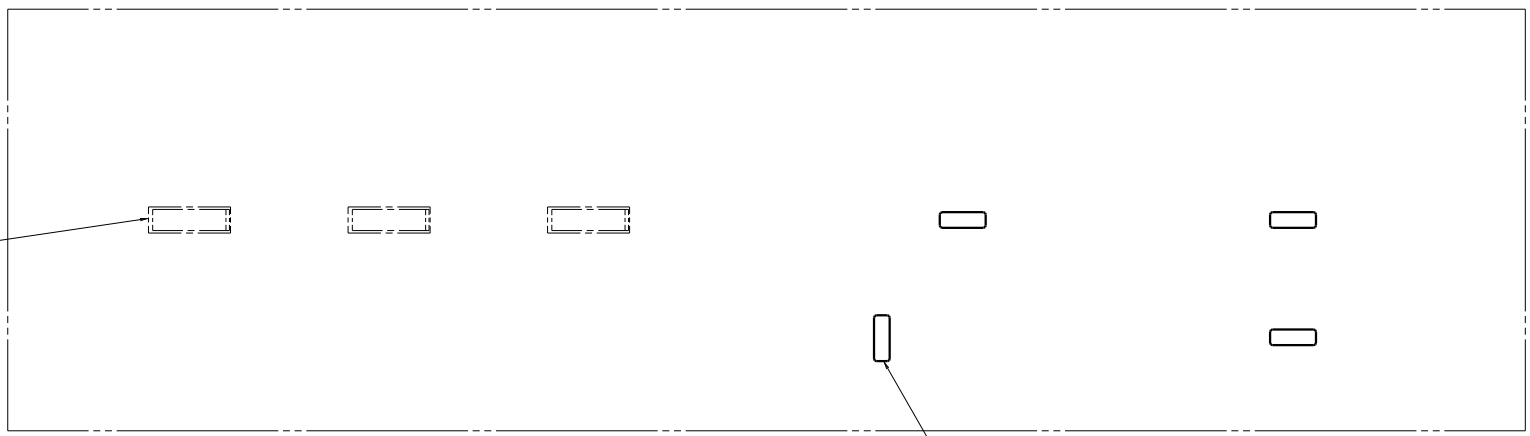

LF2N1
4

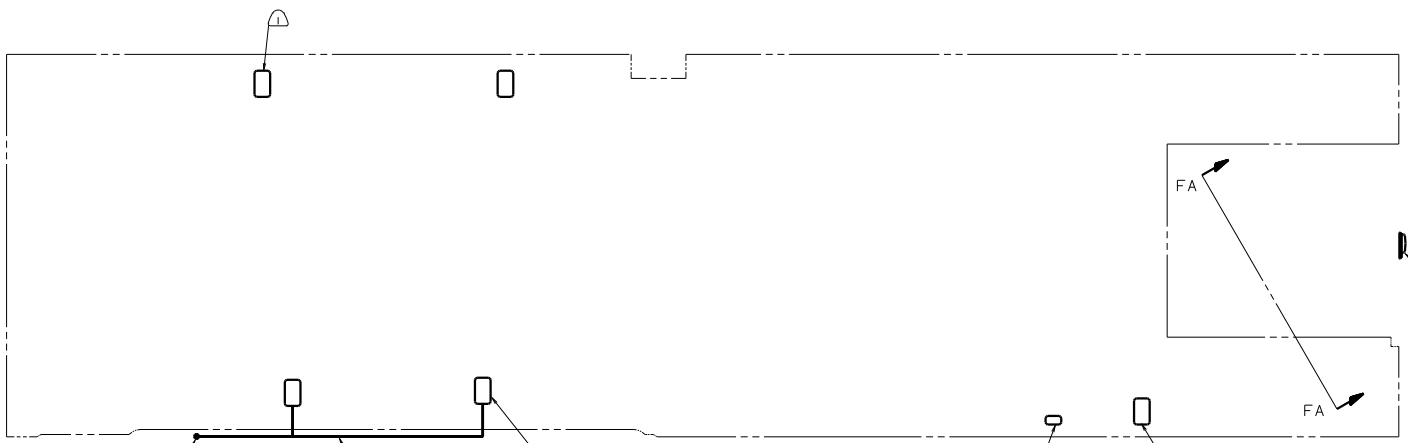

LF1-1

FA

FA

LF1-1

TO WIRE ASM-
SLIDEOUT ROOM

WIRE ASM-COMPT LAMPS
125266-09-000

LAMP
86280-01-000
SCREW
G67-10-12U (2)
CONNECTOR
58028-01-000 (2)

LF1N1

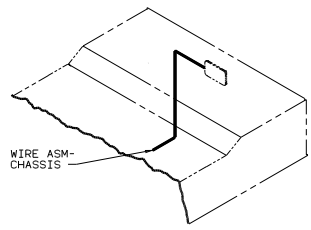

WIRE ASM-
CHASSIS

VIEW FA-FA

- (48V) LIGHTS-FLUORESCENT
- (265) CODES/STANDARDS-CSA/CWVSS
- (1B1) CODES/STANDARDS USA
- (1B1) (265) (48M) 00 P36LD

FOR ELECTRICAL
TORQUE
SPECIFICATIONS
SEE DWG NO.
128783-01-000

(X-X)
FOR
ELECTRICAL
CALL-OUTS
SEE DWG NO.
121339-01-000

NOTES:
LAMP TO BE MOUNTED WITH SWITCH OUTBOARD
AND 75 ±20 FROM EDGE OF FLOOR.

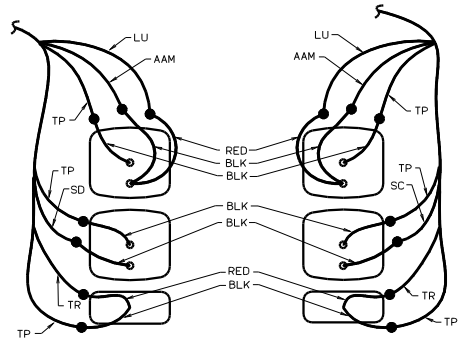

VIEW FE-FE

VIEW FD-FD

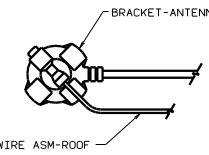

VIEW FC-FC

- LAMP-MARKER, LENS, RED 133055-01-000 (5)
- LAMP-MARKER, BASE, WHITE 133055-03-000 (5)
- BULB 36196-01-000 (5)

- WIRE ASM-BACKWALL, FL 132673-01-000

- LIGHT ASM-STOP/TURN/TAIL, RED 133054-03-000 (2)
- SCREW G11-08-12U (EXT) (4)

- LIGHT ASM-TURN/AMBER 133054-04-000 (2)
- SCREW G11-08-12U (EXT) (4)

- LAMP ASM-BACKUP 106688-01-000 (2)
- BULB 37934-01-000 (2)
- SCREW G39-08-16U (EXT) (4)

- LAMP-LICENSE 87201-01-000
- SCREW G11-06-12U (EXT) (2)

- LAMP-BRAKE, CENTER 121950-01-000
- SCREW (SUPPLIED W/LAMP)

- CONNECTOR-PLUG, TRAILER (113589-01-000) TO BE SUPPLIED IN COACH WITH (240)
- TAPE BRANCH BACK ALONG WIRE ASM WITH TAPE 8363-01-000.
- INSTALL WITH WIRES TOWARD ROOF.
- FASTEN TO VENT.
- WRAP BRACKET LEGS AROUND ANTENNA BASE.

- LAMP-PORCH 97917-01-CHT (2)
- SCREW G67-10-12U(EXT) (8)
- LAMP-PORCH 8089-02-000(2)
- SCREW G67-06-10U(EXT) (4)
- CONNECTOR 58028-01-000(4)
- SEAL

- WIRE ASM-ROOF

- LAMP-MARKER, LENS, RED 111102-03-000 (2)
- LAMP-MARKER, BASE, WHITE 111102-01-000 (2)
- SCREW G11-08-12U (EXT) (4)

- LAMP-MARKER, LENS, RED 111102-02-000(2)
- LAMP-MARKER, BASE, WHITE 111102-01-000 (2)
- SCREW G11-08-12U (EXT) (4)

- REFLECTOR-STICK ON-RED 106646-02-000 (2)

- CONNECTOR-SOCKET, TRAILER

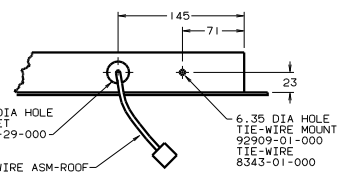

VIEW FD-FD

- PANEL-SOLAR 10 WATT 115804-01-000
- SCREW G11-08-16U(4)
- (SEE DETAIL FA)

- ANTENNA-RADIO 90944-01-000
- EXTENDER-SHAFT, ANTENNA 109889-04-000
- BRACKET-ANTENNA GROUND 108847-01-000
- SEAL 77069-02-000(3)
- CABLE EXT

- ANTENNA-RADIO 90944-01-000
- EXTENDER-SHAFT, ANTENNA 109889-04-000
- BRACKET-ANTENNA GROUND 108847-01-000
- SEAL 77069-02-000
- CABLE EXT

- LAMP-MARKER, LENS, RED 111102-03-000 (2)
- LAMP-MARKER, BASE, WHITE 111102-01-000 (2)
- SCREW G11-08-12U (EXT) (4)

- CONNECTOR-SOCKET, TRAILER

VIEW: FF-FF (240)

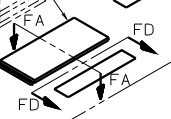
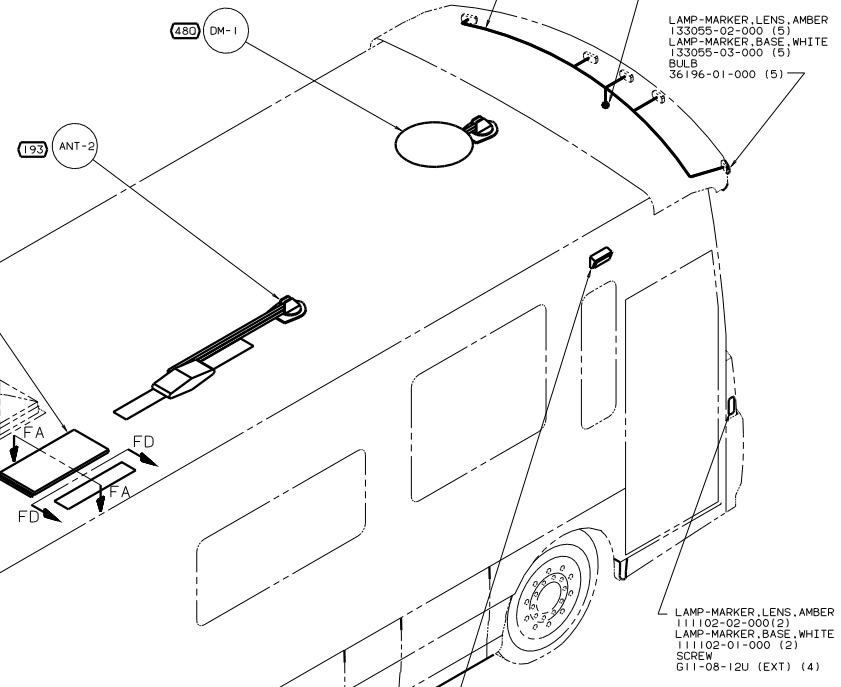

VIEW: FA-FA

- LAMP-MARKER, LENS, AMBER 111102-02-000(2)
- LAMP-MARKER, BASE, WHITE 111102-01-000 (2)
- SCREW G11-08-12U (EXT) (4)

- ANTENNA-RADIO 90944-01-000
- EXTENDER-SHAFT, ANTENNA 109889-04-000
- BRACKET-ANTENNA GROUND 108847-01-000
- SEAL 77069-02-000(3)
- CABLE EXT

- TO WIRE ASM-DIGITAL ELEV SENSOR
- FROM WIRE ASM-ROOF
- GRN
- RED
- WHT
- BLK
- JP
- JA
- DIGITAL SATELLITE ELEVATION SENSOR

DETAIL FB (480)

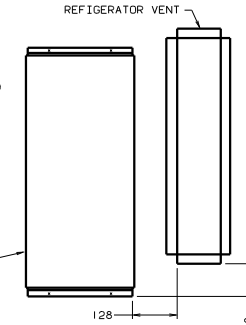

VIEW FA-FA

- REAR STEREO SYSTEM W/CASSETTE (26L)
- REAR STEREO SYSTEM W/CD (26B)
- TRAILER HITCH (240)
- ENTERTAINMENT CENTR/EXT W/CD (105)
- ENTERTAINMENT CTR/EXT CASSETTE (76C)
- SOLAR PANEL-10 WATT (230)
- CODES/STANDARDS-CSA/CMVSS (265)
- CODES/STANDARDS USA (181)