



DANGER

Danger of electrical shock, burns or death. Always remove all power sources before attempting any repair, service or diagnostic work. Power can be present from shore power, generator, inverter or battery. All power sources must be disabled and secured before performing any service.



CAUTION

If you lack the skills, tools or equipment to perform diagnostic or repair work leave such work to an authorized Winnebago Industries dealer or other qualified shop.

LOAD CENTER

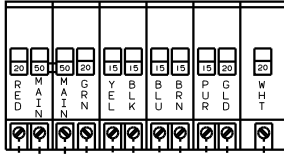

12-2 12-2 14-2 14-2 14-2 14-2 12-1 12-2

6-3

6-3

6-3

6-3

10-2

12-2

10-2

12-2

10-2

12-2

10-2

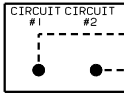

CENTRAL AIR UNIT (LOCATED IN RIGHT REAR COMPARTMENT BELOW FLOOR)

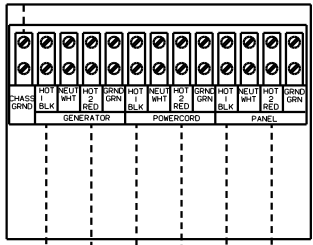

10-2

12-2

6-3

6-3

6-3

6-3

6-3

POWERCORD

GEN 4X4 BOX

GENERATOR

8 GRN

GROUND

WIRE SUPPLIED WITH GENERATOR

RECP-BEDRM,RT

RECP-BEDRM,LH

RECP-ENG HTR

RECP-FRT,RH

RECP-FRT,LH

RECP-DINETTE

RECP-EXTERIOR ENTERTAINMENT

RECP-EXTERIOR

RECP-LINEN

RECP-LOUNGE FRT,RT

RECP-BATH,GFI

RECP-CHARGER

RECP-GALLEY,GFI

RECP-GALLEY,OVHD

RECP-MICROWAVE

RECP-REFRIGERATOR

RECP-CONVERTER

RECP-WASHER/DRYER

WATER HEATER

SWITCH-WATER HEATER (LOCATED IN GALLEY AREA)

RELAY (LOCATED BEHIND LOAD CENTER)

NEUTRAL WIRES

12-3

12-3

14-2

14-2

14-2

14-2

14-1 JUMPER

14-2

14-2

14-2

14-2

14-2

14-2

14-2

14-2

14-2

14-2

14-2

14-2

14-2

14-2

14-2

14-2

14-2

14-2

14-2

14-2

14-2

14-2

14-2

14-2

14-2

14-2

14-2

14-2

14-2

14-2

14-2

14-2

14-2

14-2

14-2

14-2

14-2

14-2

14-2

14-2

14-2

14-2

14-2

14-2

14-2

14-2

14-2

14-2

14-2

14-2

14-2

14-2

14-2

14-2

14-2

14-2

14-2

14-2

14-2

14-2

14-2

14-2

14-2

14-2

14-2

14-2

14-2

14-2

14-2

14-2

14-2

14-2

14-2

14-2

14-2

14-2

14-2

14-2

14-2

14-2

14-2

14-2

14-2

14-2

14-2

14-2

14-2

14-2

14-2

14-2

14-2

14-2

14-2

14-2

14-2

14-2

14-2

14-2

14-2

14-2

14-2

14-2

- 5 6-3 WITH 6500 WATT GENERATOR AND 4-3 WITH 7500 WATT GENERATOR.
- 4 WIRE ROUTED THROUGH FLOOR.
- 3 WIRE ROUTED IN ROOF.
- 2 WIRE ROUTED IN SIDEWALL.
- 1 ALL OUTLETS DOWN STREAM AND INCLUDING THIS OUTLET ARE GROUND FAULT INTERRUPT PROTECTED.

NOTES:

00 P36L
78J ELECTRICAL SYS 50-AMP US

TITLE: WIRING DIAGRAM-BODY 110V	
NO. OF SHEETS	TOTAL SHEETS
SHEET 2 OF 4	16
131884	

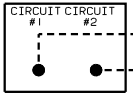
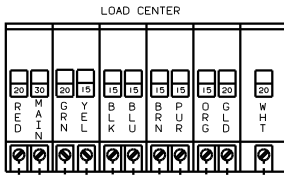

CENTRAL AIR UNIT (LOCATED IN RIGHT REAR COMPARTMENT BELOW FLOOR)

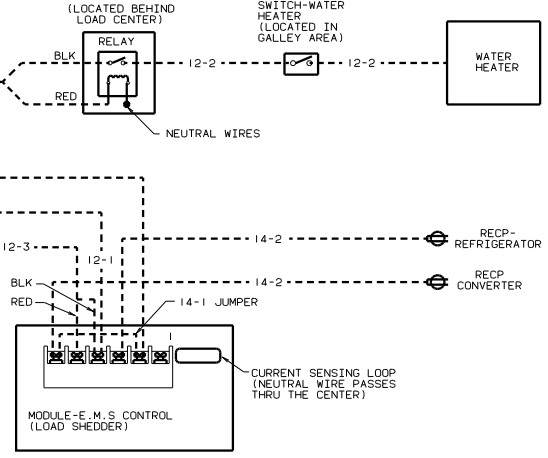
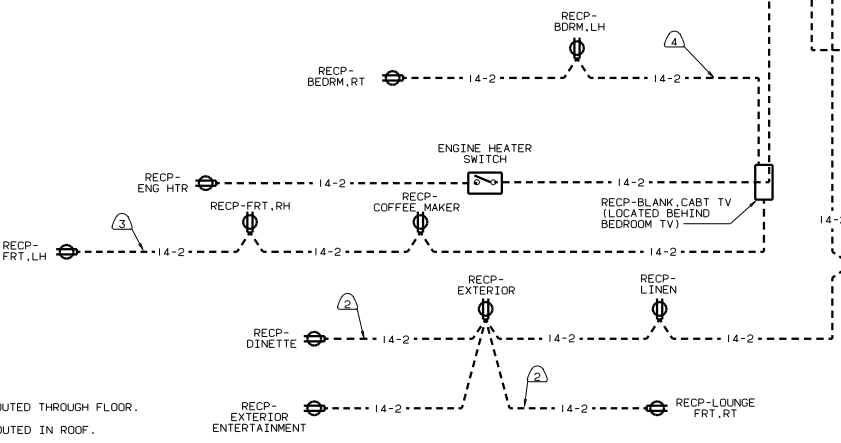
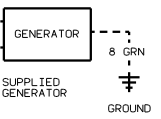
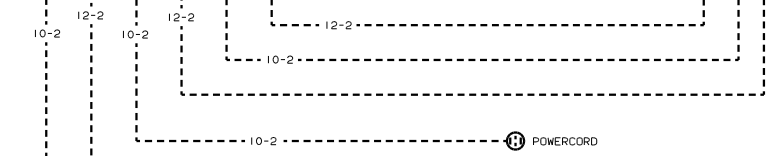
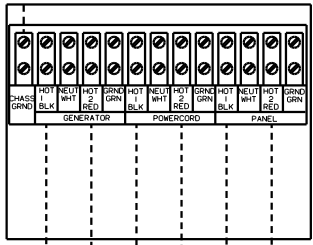

- NOTES:
- ④ WIRE ROUTED THROUGH FLOOR.
 - ③ WIRE ROUTED IN ROOF.
 - ② WIRE ROUTED IN SIDEWALL.
 - ① ALL OUTLETS DOWN STREAM AND INCLUDING THIS OUTLET ARE GROUND FAULT INTERRUPT PROTECTED.

00 P36L
12D ELECTRICAL SYS 30-AMP CAN

TITLE: WIRING DIAGRAM-BODY_110V	
NO. OF SHEETS: 4	SHEET NO: 3
DATE: 1/6	REV: 1
131884	

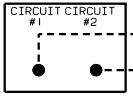
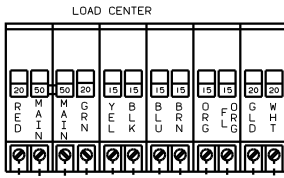

CENTRAL AIR UNIT (LOCATED IN RIGHT REAR COMPARTMENT BELOW FLOOR)

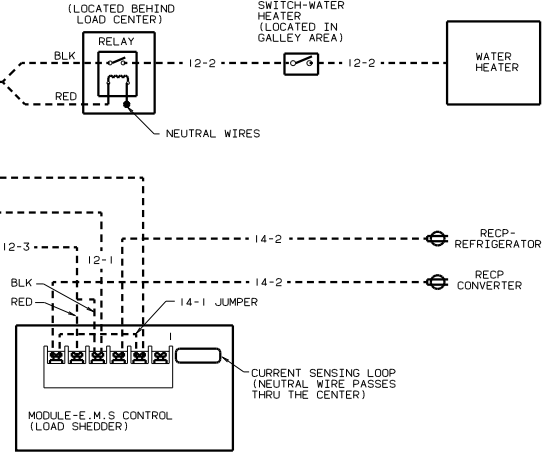
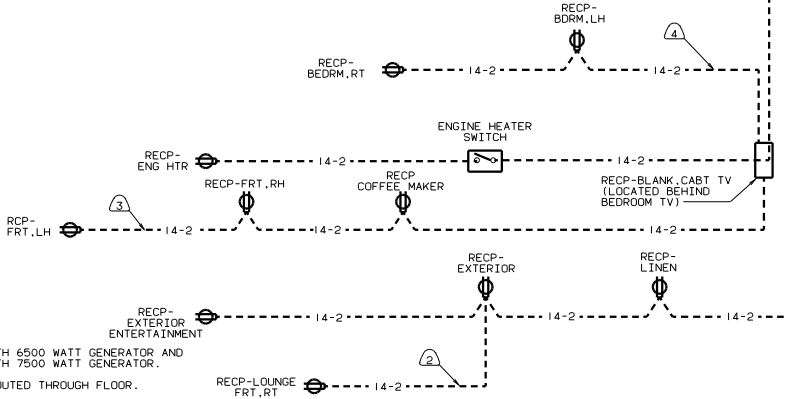
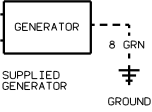
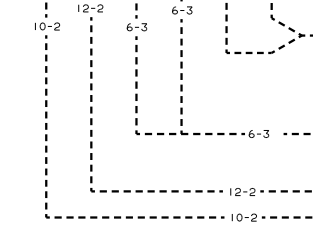
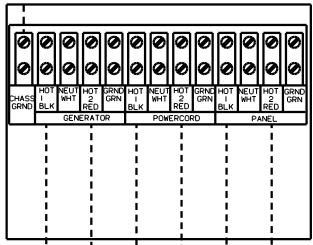

- 5 6-3 WITH 6500 WATT GENERATOR AND 4-3 WITH 7500 WATT GENERATOR.
- 4 WIRE ROUTED THROUGH FLOOR.
- 3 WIRE ROUTED IN ROOF.
- 2 WIRE ROUTED IN SIDEWALL.
- 1 ALL OUTLETS DOWN STREAM AND INCLUDING THIS OUTLET ARE GROUND FAULT INTERRUPT PROTECTED.

00 P36L
78J ELECTRICAL SYS 50-AMP CAN

TITLE: WIRING DIAGRAM-BODY 110V	
NO. OF SHEETS	TOT. SHEETS
4	4
131884	