



DANGER

Danger of electrical shock, burns or death. Always remove all power sources before attempting any repair, service or diagnostic work. Power can be present from shore power, generator, inverter or battery. All power sources must be disabled and secured before performing any service.



CAUTION

If you lack the skills, tools or equipment to perform diagnostic or repair work leave such work to an authorized Winnebago Industries dealer or other qualified shop.

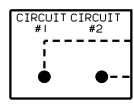
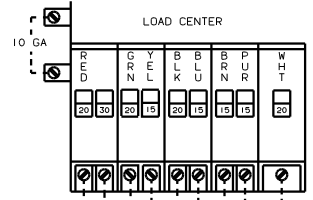

CENTRAL AIR UNIT (LOCATED IN RIGHT REAR COMPARTMENT BELOW FLOOR)

AUTOMATIC TRANSFER SWITCH

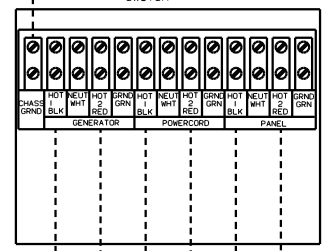

8 GRN GROUND

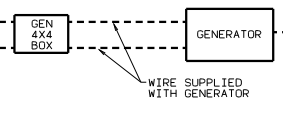

WIRE SUPPLIED WITH GENERATOR

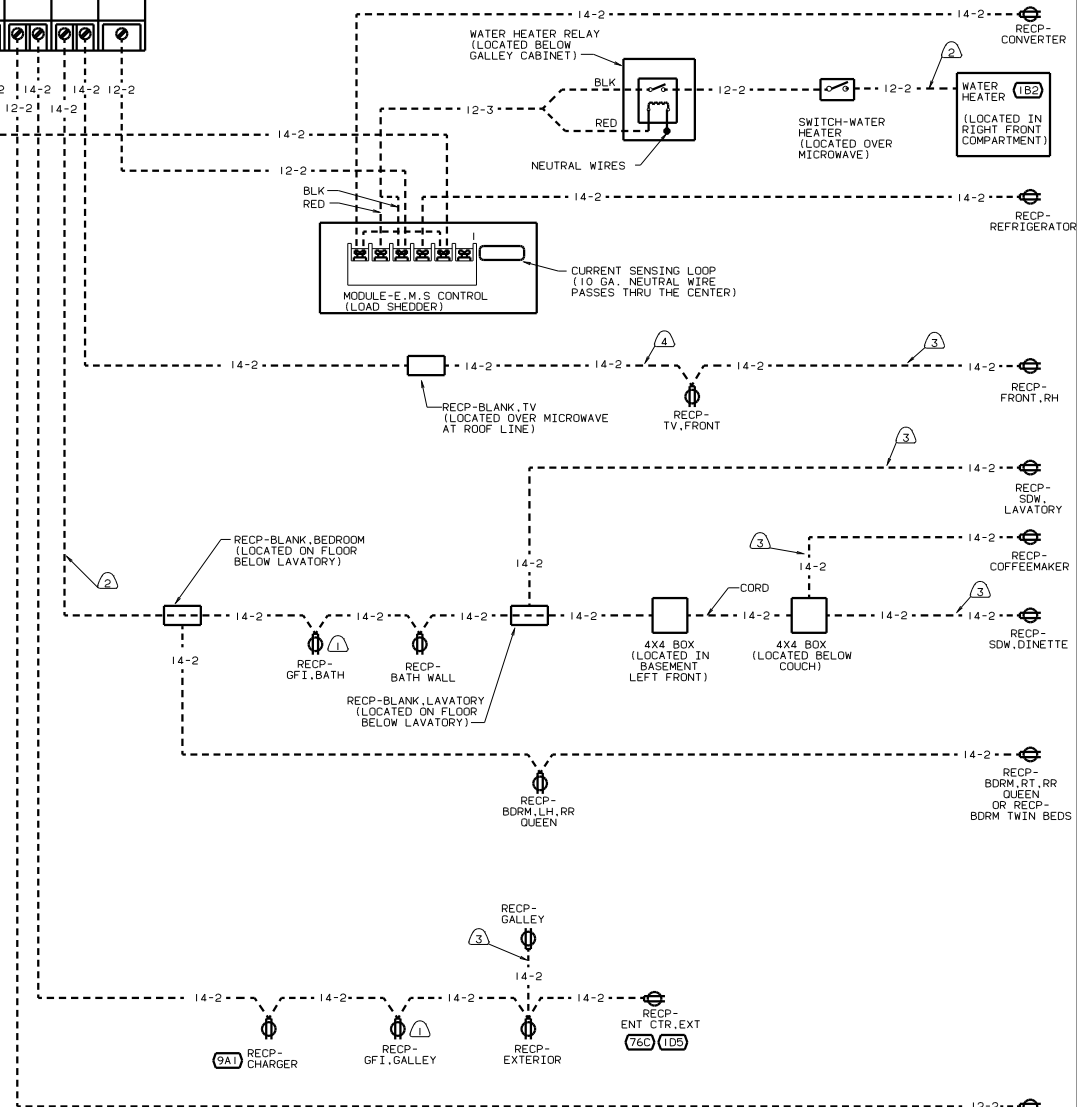

- ④ WIRE IN ROOF
- ③ WIRE IN SIDEWALL
- ② WIRE BELOW FLOOR
- ⚠ ALL OUTLETS DOWN STREAM AND INCLUDING THIS OUTLET ARE GROUND FAULT INTERRUPT PROTECTED.

NOTES:

- 9A1 ACCESSORY PACKAGE
- 76C ENTERTAINMENT CTR/EXT CASSETTE
- 1D5 ENTERTAINMENT CTR/EXT W/CD
- 1B2 WTR HTR-10GAL/ELEC/LP/MTR/AID

①20 ELECTRICAL SYSTEM 30 AMP
 ①B1 CODES/STANDARDS USA

WINNEBAGO 00 G32V

DATE	UNDESIGNED TOLERANCES ARE:	MATERIAL
DATE	WHOLE OR 1/2"	
DATE	ONE PLACE (1/32)"	
DATE	TWO PLACE (1/64)"	
DATE	THREE PLACE (1/128)"	
DATE	FOUR PLACE (1/256)"	
DATE	FIVE PLACE (1/512)"	
DATE	SIX PLACE (1/1024)"	
DATE	SEVEN PLACE (1/2048)"	
DATE	EIGHT PLACE (1/4096)"	
DATE	NINE PLACE (1/8192)"	
DATE	TEN PLACE (1/16384)"	

LAYOUT: _____ TITLE: **WIRING DIAGRAM-BODY, 110V**

DIA # _____ SCALE: NONE TO THE SCALE SHOWN

ALL DIMENSIONS ARE IN MILLIMETERS SHEET 1 OF 4

REF: 131735 A 1

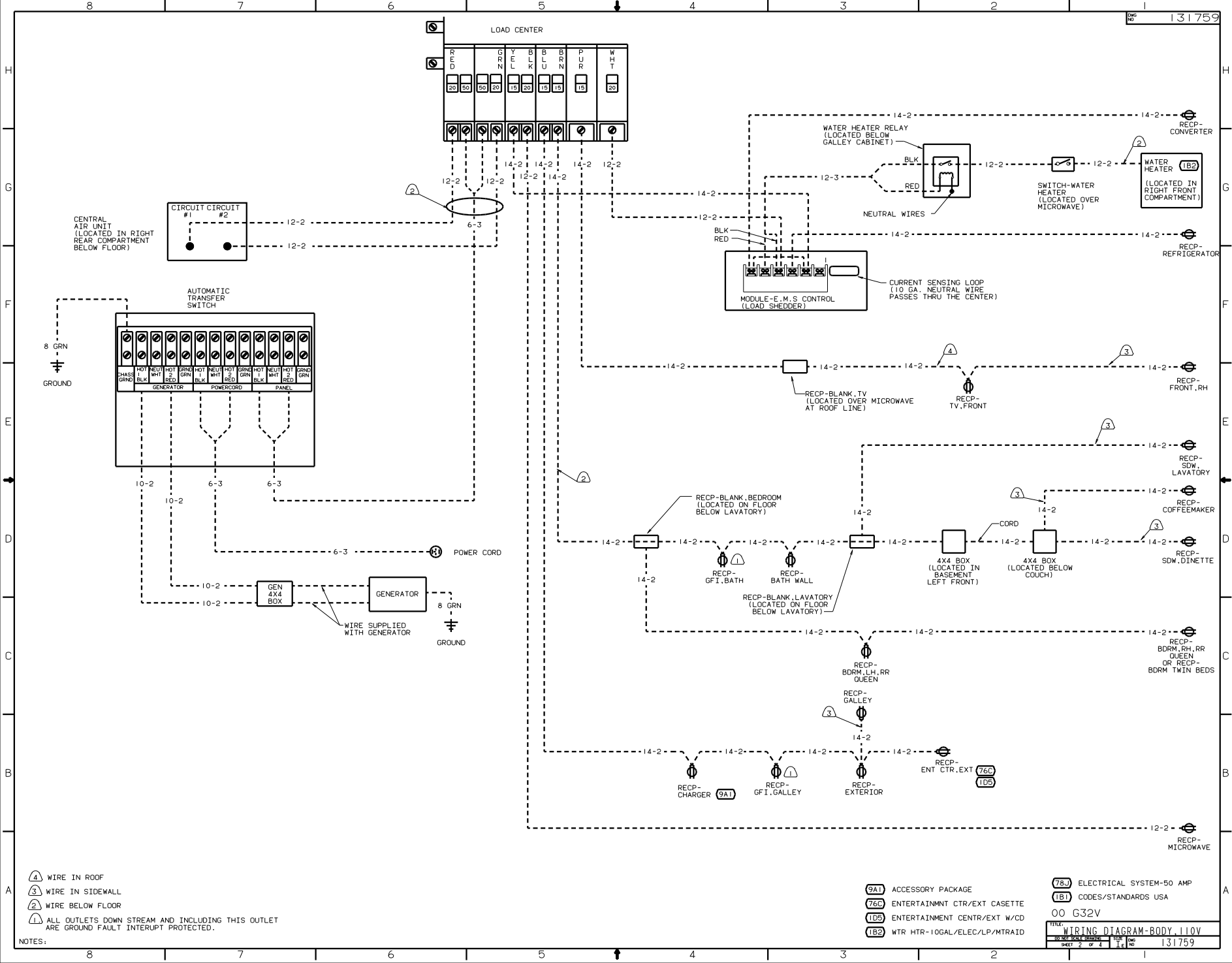

LOAD CENTER

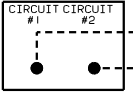
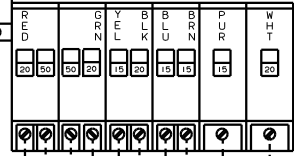

CENTRAL AIR UNIT (LOCATED IN RIGHT REAR COMPARTMENT BELOW FLOOR)

AUTOMATIC TRANSFER SWITCH

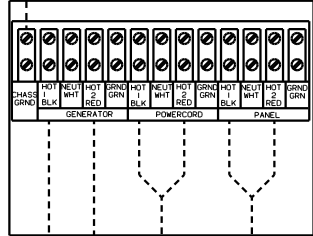

8 GRN GROUND

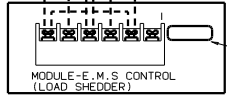

WATER HEATER RELAY (LOCATED BELOW GALLEY CABINET)

SWITCH-WATER HEATER (LOCATED OVER MICROWAVE)

WATER HEATER (LOCATED IN RIGHT FRONT COMPARTMENT)

RECP-REFRIGERATOR

CURRENT SENSING LOOP (10 GA. NEUTRAL WIRE PASSES THROUGH THE CENTER)

RECP-BLANK, TV (LOCATED OVER MICROWAVE AT ROOF LINE)

RECP-TV, FRONT

RECP-FRONT, RH

RECP-BLANK, BEDROOM (LOCATED ON FLOOR BELOW LAVATORY)

RECP-GFI, BATH

RECP-BATH WALL

RECP-BLANK, LAVATORY (LOCATED ON FLOOR BELOW LAVATORY)

RECP-BDRM, LH, RR QUEEN

RECP-GALLEY

RECP-CHARGER (9A1)

RECP-GFI, GALLEY

RECP-EXTERIOR

RECP-ENT CTR, EXT (76C) (1D5)

RECP-MICROWAVE

- ④ WIRE IN ROOF
- ③ WIRE IN SIDEWALL
- ② WIRE BELOW FLOOR
- ⚠ ALL OUTLETS DOWN STREAM AND INCLUDING THIS OUTLET ARE GROUND FAULT INTERRUPT PROTECTED.

- (9A1) ACCESSORY PACKAGE
- (76C) ENTERTAINMENT CTR/EXT CASSETTE
- (1D5) ENTERTAINMENT CENTR/EXT W/CD
- (1B2) WTR HTR-10GAL/ELEC/LP/MTR/TRAID
- (78U) ELECTRICAL SYSTEM-50 AMP
- (1B1) CODES/STANDARDS USA

00 G32V
 TITLE: WIRING DIAGRAM-BODY, 110V
 SHEET 2 OF 4

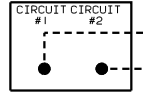
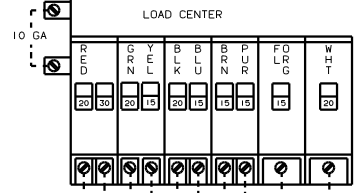

CENTRAL AIR UNIT
(LOCATED IN RIGHT REAR COMPARTMENT BELOW FLOOR)

AUTOMATIC TRANSFER SWITCH

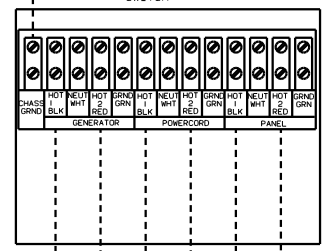

8 GRN
GROUND

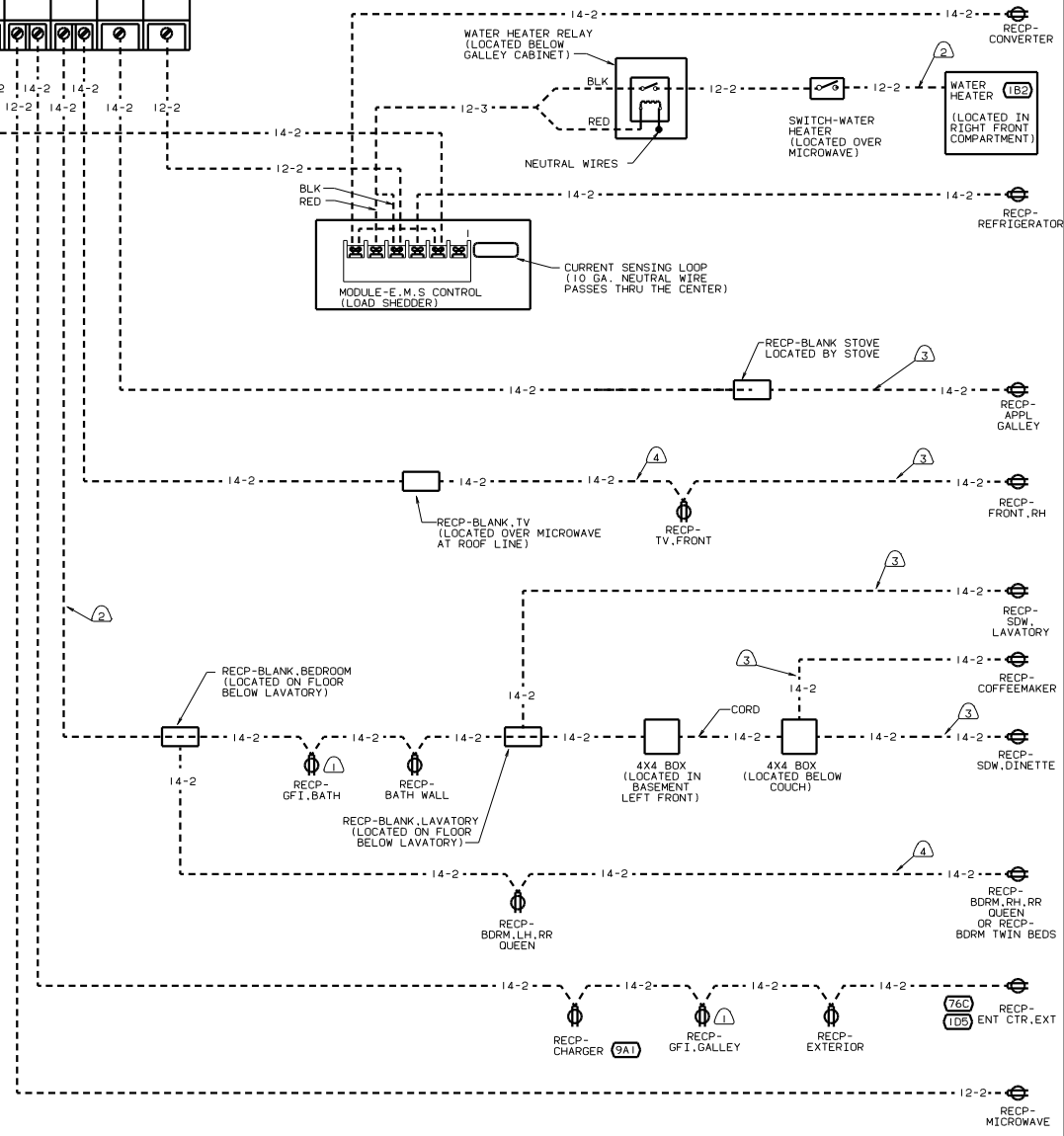
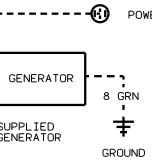

- ④ WIRE IN ROOF
- ③ WIRE IN SIDEWALL
- ② WIRE BELOW FLOOR
- ① ALL OUTLETS DOWN STREAM AND INCLUDING THIS OUTLET ARE GROUND FAULT INTERRUPT PROTECTED.

- 9A1 ACCESSORY PACKAGE
- 76C ENTERTAINMENT CTR/EXT CASSETTE
- 1D5 ENTERTAINMENT CTR/EXT W/CD
- 1B2 WTR HTR-10GAL/ELEC/LP/MTR/AID
- 265 CODES/STANDARDS-CSA/CMVSS
- 12D ELECTRICAL SYSTEM 30 AMP

00 G32V
 TITLE: WIRING DIAGRAM-BODY, 110V
 SHEET 3 OF 4

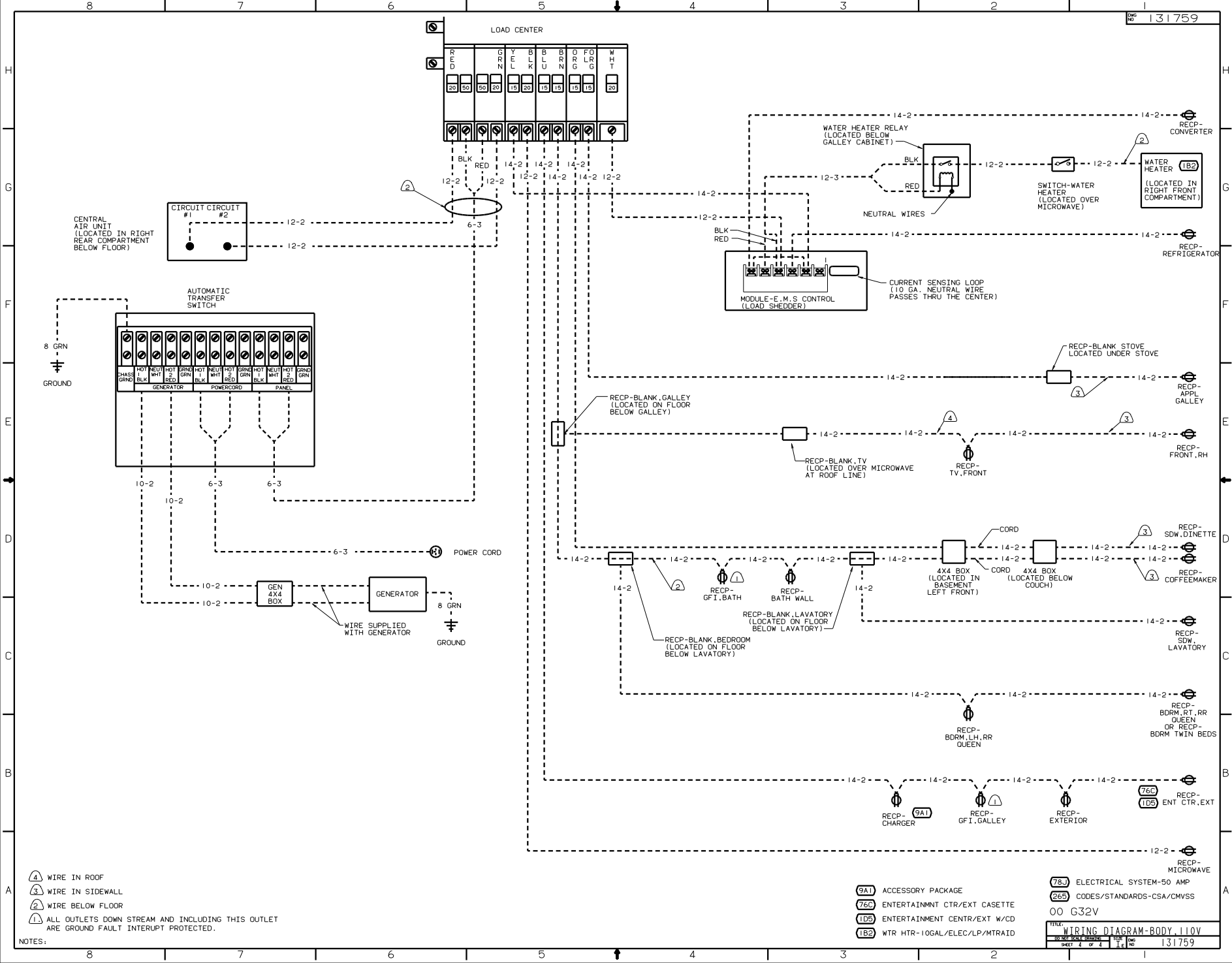

LOAD CENTER

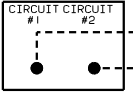
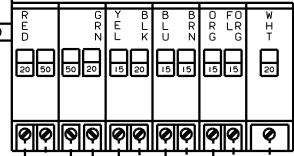

CENTRAL AIR UNIT (LOCATED IN RIGHT REAR COMPARTMENT BELOW FLOOR)

AUTOMATIC TRANSFER SWITCH

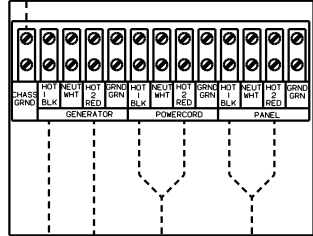

8 GRN
GROUND

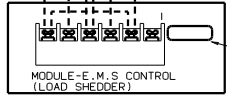
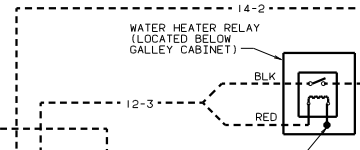
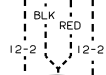

- NOTES:
- ④ WIRE IN ROOF
 - ③ WIRE IN SIDEWALL
 - ② WIRE BELOW FLOOR
 - ① ALL OUTLETS DOWN STREAM AND INCLUDING THIS OUTLET ARE GROUND FAULT INTERRUPT PROTECTED.

91A	ACCESSORY PACKAGE	78J	ELECTRICAL SYSTEM-50 AMP
76C	ENTERTAINMENT CTR/EXT CASSETTE	265	CODES/STANDARDS-CSA/CMVSS
105	ENTERTAINMENT CTR/EXT W/CD		00 G32V
1B2	WTR HTR-10GAL/ELEC/LP/MTR/TRAID		

TITLE: WIRING DIAGRAM-BODY, 110V

NO. OF SHEETS: 4 SHEET 4 OF 4

131759