



DANGER

Danger of electrical shock, burns or death. Always remove all power sources before attempting any repair, service or diagnostic work. Power can be present from shore power, generator, inverter or battery. All power sources must be disabled and secured before performing any service.



CAUTION

If you lack the skills, tools or equipment to perform diagnostic or repair work leave such work to an authorized Winnebago Industries dealer or other qualified shop.

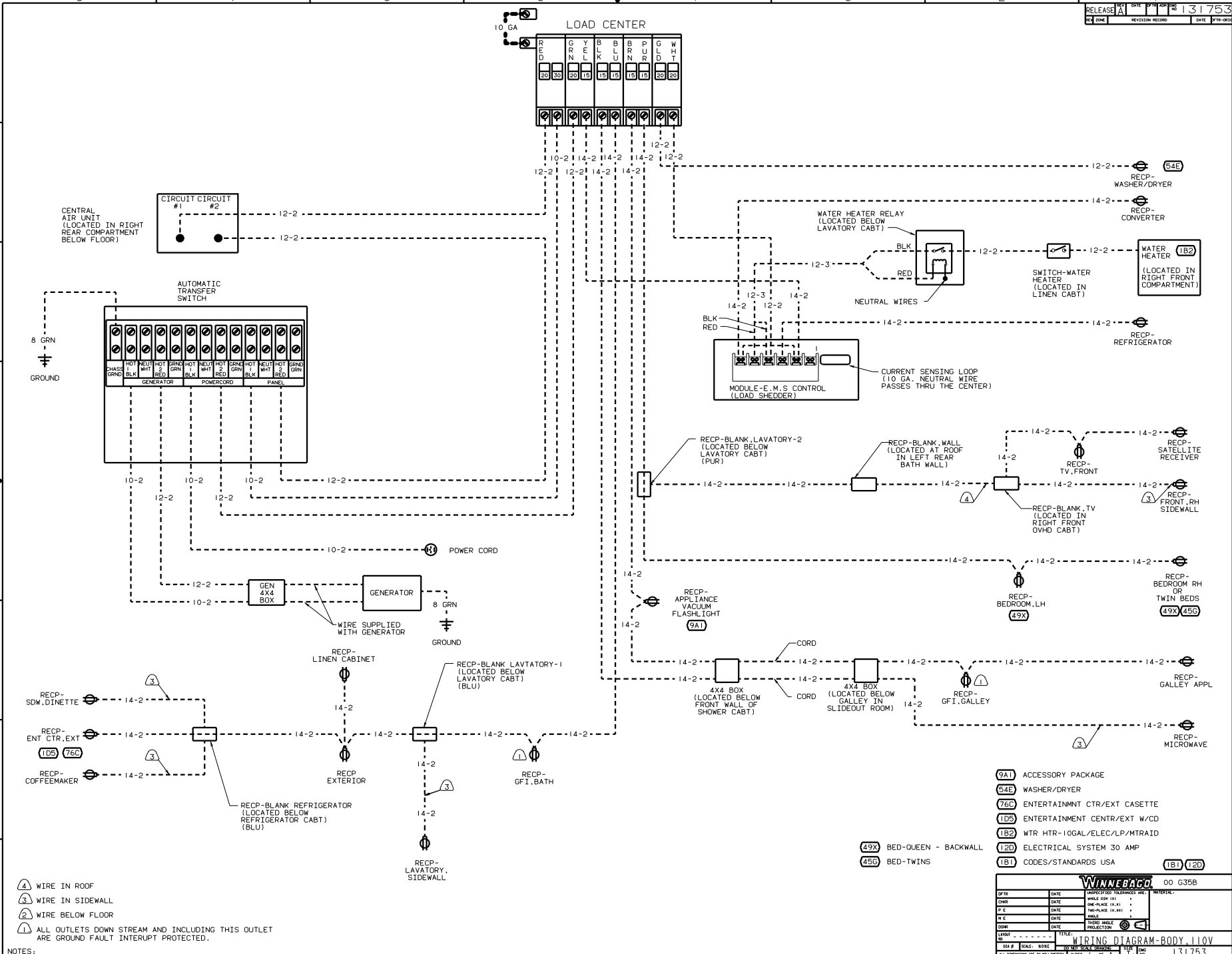
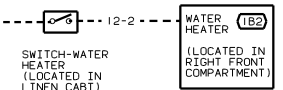
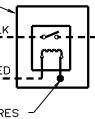
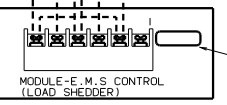
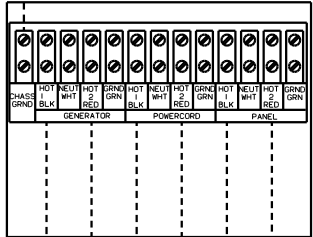
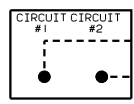
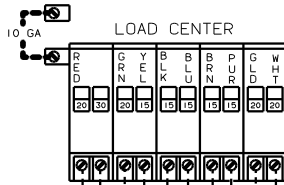

- ④ WIRE IN ROOF
- ③ WIRE IN SIDEWALL
- ② WIRE BELOW FLOOR
- ① ALL OUTLETS DOWN STREAM AND INCLUDING THIS OUTLET ARE GROUND FAULT INTERRUPT PROTECTED.

- ⑨A1 ACCESSORY PACKAGE
- ⑤4E WASHER/DRYER
- ⑦6C ENTERTAINMNT CTR/EXT CASSETTE
- ①D5 ENTERTAINMENT CTR/EXT W/CD
- ①B2 WTR HTR-10GAL/ELEC/LP/MTRAIID
- ①2D ELECTRICAL SYSTEM 30 AMP
- ①B1 CODES/STANDARDS USA
- ④9X BED-QUEEN - BACKWALL
- ④5B BED-TWINS

WINNEBAGO		00 G358
DATE	UNDESIGNED TOLERANCES ARE:	MATERIAL:
DATE	WHOLE OR 1/2	
DATE	ONE-PLACE (1/32)	
DATE	TWO-PLACE (1/64)	
DATE	THREE-PLACE (1/128)	
DATE	FOUR-PLACE (1/256)	
DATE	FIVE-PLACE (1/512)	
DATE	SIX-PLACE (1/1024)	
DATE	SEVEN-PLACE (1/2048)	
DATE	EIGHT-PLACE (1/4096)	
DATE	NINE-PLACE (1/8192)	
DATE	TEN-PLACE (1/16384)	
DATE	ELEVEN-PLACE (1/32768)	
DATE	TWELVE-PLACE (1/65536)	
DATE	THIRTEEN-PLACE (1/131072)	
DATE	FOURTEEN-PLACE (1/262144)	
DATE	FIFTEEN-PLACE (1/524288)	
DATE	SIXTEEN-PLACE (1/1048576)	
DATE	SEVENTEEN-PLACE (1/2097152)	
DATE	EIGHTEEN-PLACE (1/4194304)	
DATE	NINETEEN-PLACE (1/8388608)	
DATE	TWENTY-PLACE (1/16777216)	
DATE	TWENTY-ONE-PLACE (1/33554432)	
DATE	TWENTY-TWO-PLACE (1/67108864)	
DATE	TWENTY-THREE-PLACE (1/134217728)	
DATE	TWENTY-FOUR-PLACE (1/268435456)	
DATE	TWENTY-FIVE-PLACE (1/536870912)	
DATE	TWENTY-SIX-PLACE (1/1073741824)	
DATE	TWENTY-SEVEN-PLACE (1/2147483648)	
DATE	TWENTY-EIGHT-PLACE (1/4294967296)	
DATE	TWENTY-NINE-PLACE (1/8589934592)	
DATE	THIRTY-PLACE (1/17179869184)	
DATE	THIRTY-ONE-PLACE (1/34359738368)	
DATE	THIRTY-TWO-PLACE (1/68719476736)	
DATE	THIRTY-THREE-PLACE (1/137438953472)	
DATE	THIRTY-FOUR-PLACE (1/274877906944)	
DATE	THIRTY-FIVE-PLACE (1/549755813888)	
DATE	THIRTY-SIX-PLACE (1/1099511627776)	
DATE	THIRTY-SEVEN-PLACE (1/2199023255552)	
DATE	THIRTY-EIGHT-PLACE (1/4398046511104)	
DATE	THIRTY-NINE-PLACE (1/8796093022208)	
DATE	FOURTY-PLACE (1/17592186044416)	
DATE	FOURTY-ONE-PLACE (1/35184372088832)	
DATE	FOURTY-TWO-PLACE (1/70368744177664)	
DATE	FOURTY-THREE-PLACE (1/140737488355328)	
DATE	FOURTY-FOUR-PLACE (1/281474976710656)	
DATE	FOURTY-FIVE-PLACE (1/562949953421312)	
DATE	FOURTY-SIX-PLACE (1/1125899906842624)	
DATE	FOURTY-SEVEN-PLACE (1/2251799813685248)	
DATE	FOURTY-EIGHT-PLACE (1/4503599627370496)	
DATE	FOURTY-NINE-PLACE (1/9007199254740992)	
DATE	FIFTY-PLACE (1/18014398509481984)	
DATE	FIFTY-ONE-PLACE (1/36028797018963968)	
DATE	FIFTY-TWO-PLACE (1/72057594037927936)	
DATE	FIFTY-THREE-PLACE (1/144115188075855872)	
DATE	FIFTY-FOUR-PLACE (1/288230376151711744)	
DATE	FIFTY-FIVE-PLACE (1/576460752303423488)	
DATE	FIFTY-SIX-PLACE (1/1152921504606846976)	
DATE	FIFTY-SEVEN-PLACE (1/2305843009213693952)	
DATE	FIFTY-EIGHT-PLACE (1/4611686018427387904)	
DATE	FIFTY-NINE-PLACE (1/9223372036854775808)	
DATE	SIXTY-PLACE (1/18446744073709551616)	
DATE	SIXTY-ONE-PLACE (1/36893488147419103232)	
DATE	SIXTY-TWO-PLACE (1/73786976294838206464)	
DATE	SIXTY-THREE-PLACE (1/147573952589676412928)	
DATE	SIXTY-FOUR-PLACE (1/295147905179352825856)	
DATE	SIXTY-FIVE-PLACE (1/590295810358705651712)	
DATE	SIXTY-SIX-PLACE (1/1180591620717411303424)	
DATE	SIXTY-SEVEN-PLACE (1/2361183241434822606848)	
DATE	SIXTY-EIGHT-PLACE (1/4722366482869645213696)	
DATE	SIXTY-NINE-PLACE (1/9444732965739290427392)	
DATE	SEVENTY-PLACE (1/18889465134718580854784)	
DATE	SEVENTY-ONE-PLACE (1/37778930269437161709568)	
DATE	SEVENTY-TWO-PLACE (1/75557860538874323419136)	
DATE	SEVENTY-THREE-PLACE (1/151115721077748646838272)	
DATE	SEVENTY-FOUR-PLACE (1/302231442155497293676544)	
DATE	SEVENTY-FIVE-PLACE (1/604462884310994587353088)	
DATE	SEVENTY-SIX-PLACE (1/1208925768621989174706176)	
DATE	SEVENTY-SEVEN-PLACE (1/2417851537243978349412352)	
DATE	SEVENTY-EIGHT-PLACE (1/4835703074487956698824704)	
DATE	SEVENTY-NINE-PLACE (1/9671406148975913397649408)	
DATE	EIGHTY-PLACE (1/19342812297951826795298816)	
DATE	EIGHTY-ONE-PLACE (1/38685624595903653590597632)	
DATE	EIGHTY-TWO-PLACE (1/77371249191807307181195264)	
DATE	EIGHTY-THREE-PLACE (1/154742498383614614362390528)	
DATE	EIGHTY-FOUR-PLACE (1/309484996767229228724781056)	
DATE	EIGHTY-FIVE-PLACE (1/618969993534458457449562112)	
DATE	EIGHTY-SIX-PLACE (1/1237939987068916914891244224)	
DATE	EIGHTY-SEVEN-PLACE (1/2475879974137833829782488448)	
DATE	EIGHTY-EIGHT-PLACE (1/4951759948275667659564976896)	
DATE	EIGHTY-NINE-PLACE (1/9903519896551335319129953792)	
DATE	NINETY-PLACE (1/19807039793102670638259907584)	
DATE	NINETY-ONE-PLACE (1/39614079586205341276519815168)	
DATE	NINETY-TWO-PLACE (1/79228159172410682553039630336)	
DATE	NINETY-THREE-PLACE (1/158456318344821365106079260672)	
DATE	NINETY-FOUR-PLACE (1/316912636689642730212158521344)	
DATE	NINETY-FIVE-PLACE (1/633825273379285460424317042688)	
DATE	NINETY-SIX-PLACE (1/1267650546758570920848634085376)	
DATE	NINETY-SEVEN-PLACE (1/2535301093517141841697268170672)	
DATE	NINETY-EIGHT-PLACE (1/5070602187034283683394536341344)	
DATE	NINETY-NINE-PLACE (1/1014120437406856736678907682688)	
DATE	HUNDRED-PLACE (1/2028240874813713473357815365376)	

REV	DATE	TITLE	BY
1		WIRING DIAGRAM-BODY 110V	
2			
3			
4			

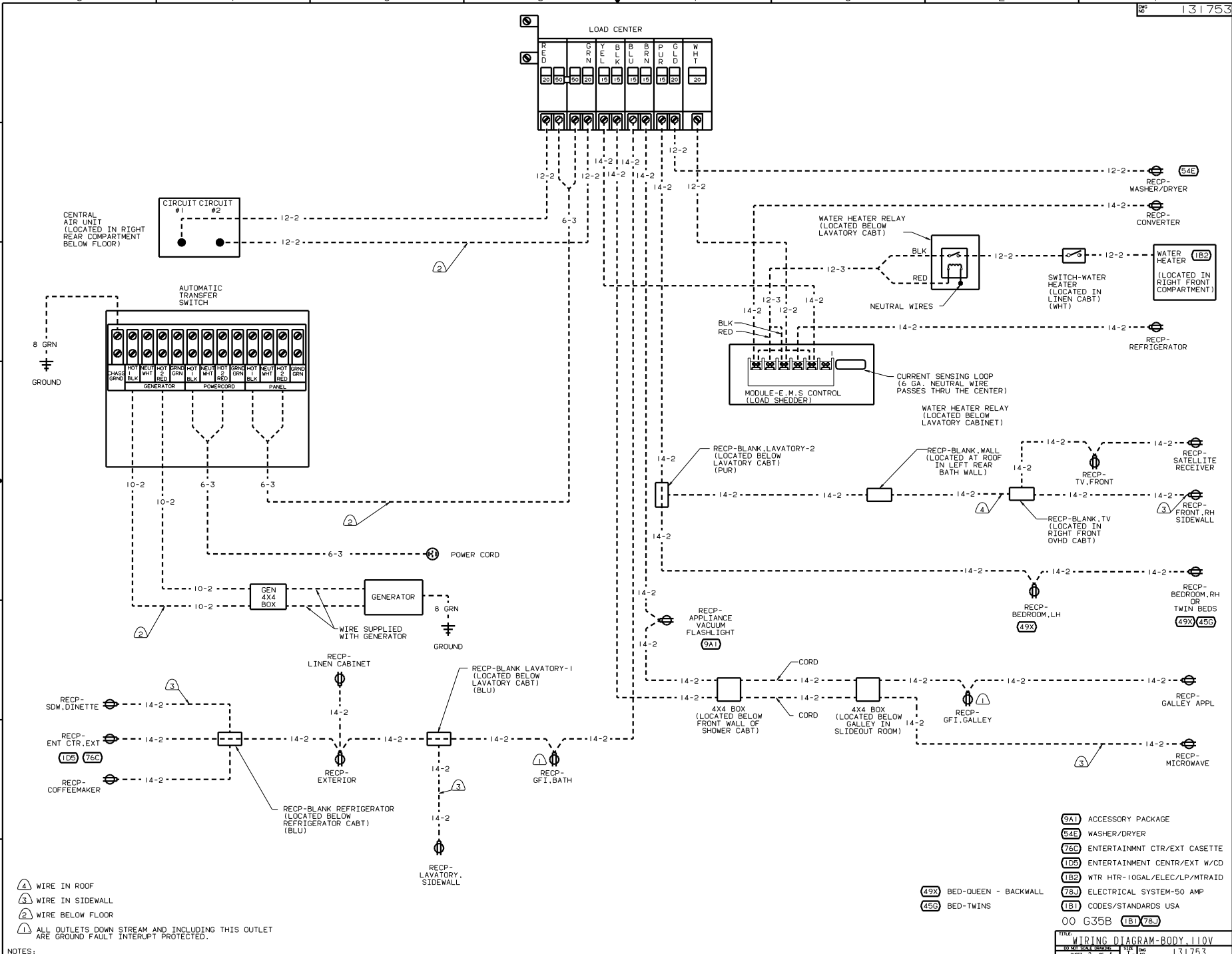

- (4) WIRE IN ROOF
- (3) WIRE IN SIDEWALL
- (2) WIRE BELOW FLOOR
- (1) ALL OUTLETS DOWN STREAM AND INCLUDING THIS OUTLET ARE GROUND FAULT INTERRUPT PROTECTED.

- (9A1) ACCESSORY PACKAGE
- (54E) WASHER/DRYER
- (76C) ENTERTAINMNT CTR/EXT CASSETTE
- (1DB) ENTERTAINMNT CTR/EXT W/CD
- (1B2) WTR HTR-10GAL/ELEC/LP/MTR/RAID
- (78J) ELECTRICAL SYSTEM-50 AMP
- (1B1) CODES/STANDARDS USA
- 00 G35B (1B1) (78J)

- (49X) BED-QUEEN - BACKWALL
- (45G) BED-TWINS

TITLE		WIRING DIAGRAM-BODY, 110V	
NO. OF SHEETS	TOTAL SHEETS	DWG. NO.	131753
SHEET 2	OF 4	FILE NO.	

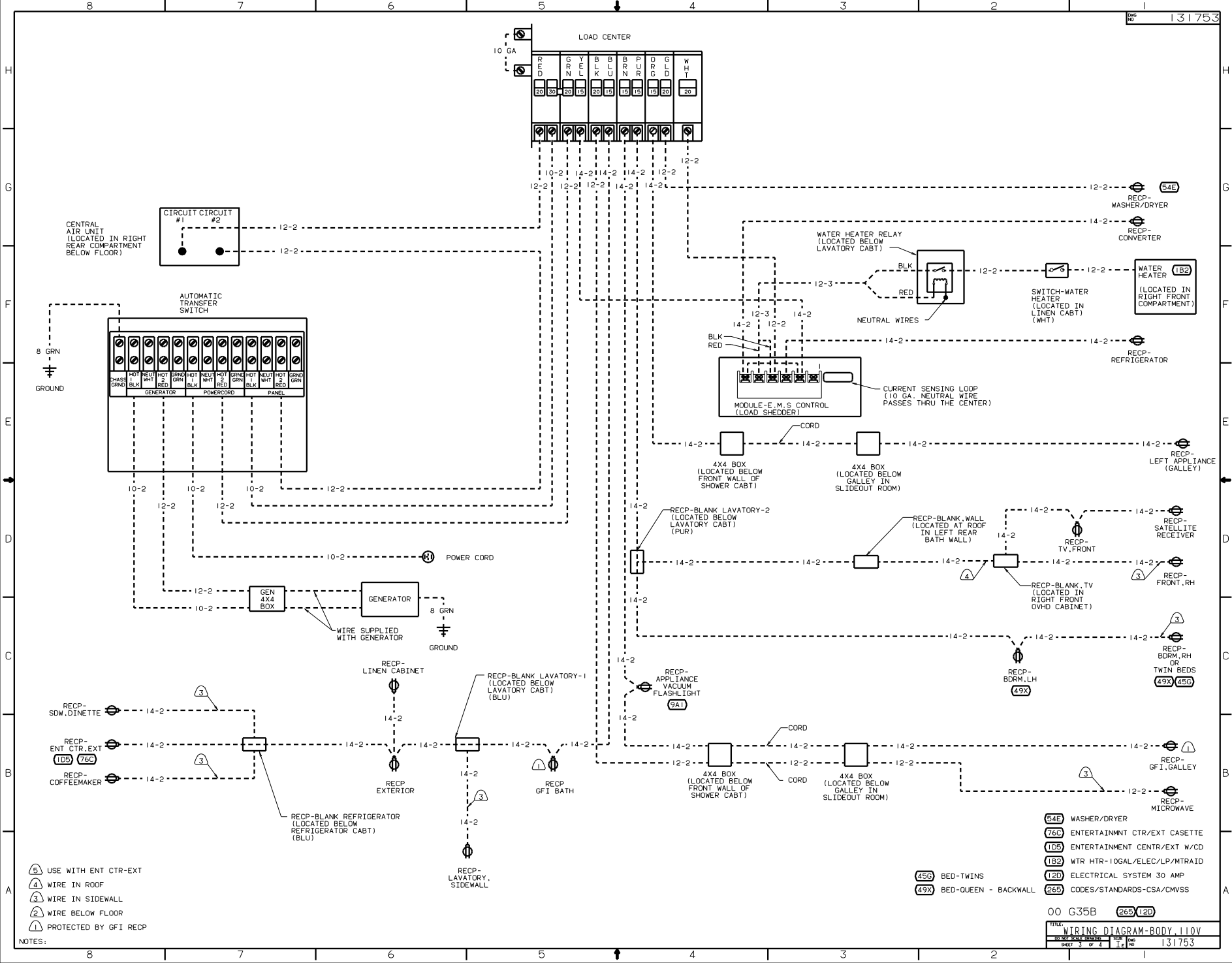

LOAD CENTER

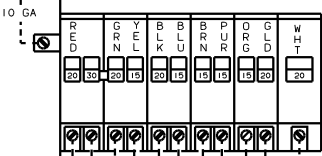

CENTRAL AIR UNIT (LOCATED IN RIGHT REAR COMPARTMENT BELOW FLOOR)

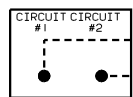

AUTOMATIC TRANSFER SWITCH

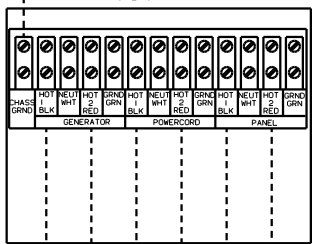

8 GRN GROUND



- NOTES:
- ⑤ USE WITH ENT CTR-EXT
 - ④ WIRE IN ROOF
 - ③ WIRE IN SIDEWALL
 - ② WIRE BELOW FLOOR
 - ① PROTECTED BY GFI RECP

- ⑤4E WASHER/DRYER
- ⑦6C ENTERTAINMENT CTR/EXT CASSETTE
- ①05 ENTERTAINMENT CENTR/EXT W/CD
- ①20 WTR HTR - 10GAL/ELEC/LP/MTR/RAID
- ④50 BED-TWINS
- ④9X BED-QUEEN - BACKWALL
- ②65 CODES/STANDARDS-CSA/CMVSS

00 G35B		②65 ①20
TITLE: WIRING DIAGRAM-BODY 110V		
NO. OF SCALE SHEETS	SHEET NO.	TOTAL SHEETS
3	3	4
131753		1

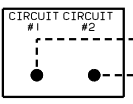
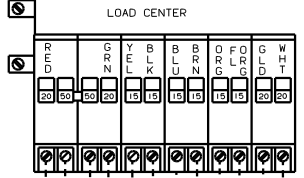

CENTRAL AIR UNIT
(LOCATED IN RIGHT REAR COMPARTMENT BELOW FLOOR)

AUTOMATIC TRANSFER SWITCH

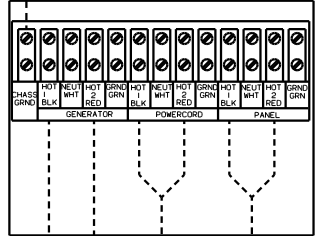

8 GRN +
GROUND

- NOTES:
- (4) WIRE IN ROOF
 - (3) WIRE IN SIDEWALL
 - (2) WIRE BELOW FLOOR
 - (1) ALL OUTLETS DOWN STREAM AND INCLUDING THIS OUTLET ARE GROUND FAULT INTERRUPT PROTECTED.

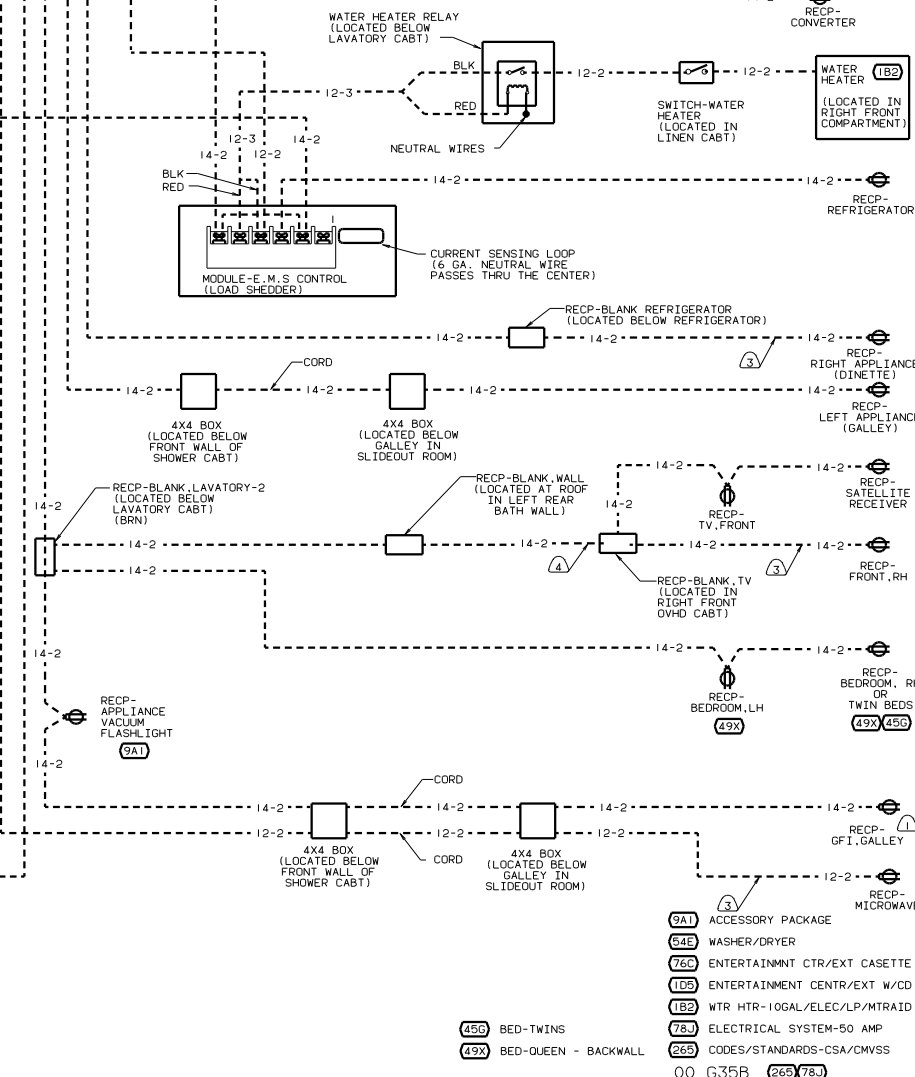

- (9A1) ACCESSORY PACKAGE
- (54E) WASHER/DRYER
- (76C) ENTERTAINMENT CTR/EXT CASSETTE
- (1D5) ENTERTAINMENT CTR/EXT W/CD
- (1B2) WTR HTR-10GAL/ELEC/LP/M/TRAID
- (78U) ELECTRICAL SYSTEM-50 AMP
- (26S) CODES/STANDARDS-CSA/CMVSS
- (45G) BED-TWINS
- (49X) BED-QUEEN - BACKWALL