



DANGER

Danger of electrical shock, burns or death. Always remove all power sources before attempting any repair, service or diagnostic work. Power can be present from shore power, generator, inverter or battery. All power sources must be disabled and secured before performing any service.



CAUTION

If you lack the skills, tools or equipment to perform diagnostic or repair work leave such work to an authorized Winnebago Industries dealer or other qualified shop.

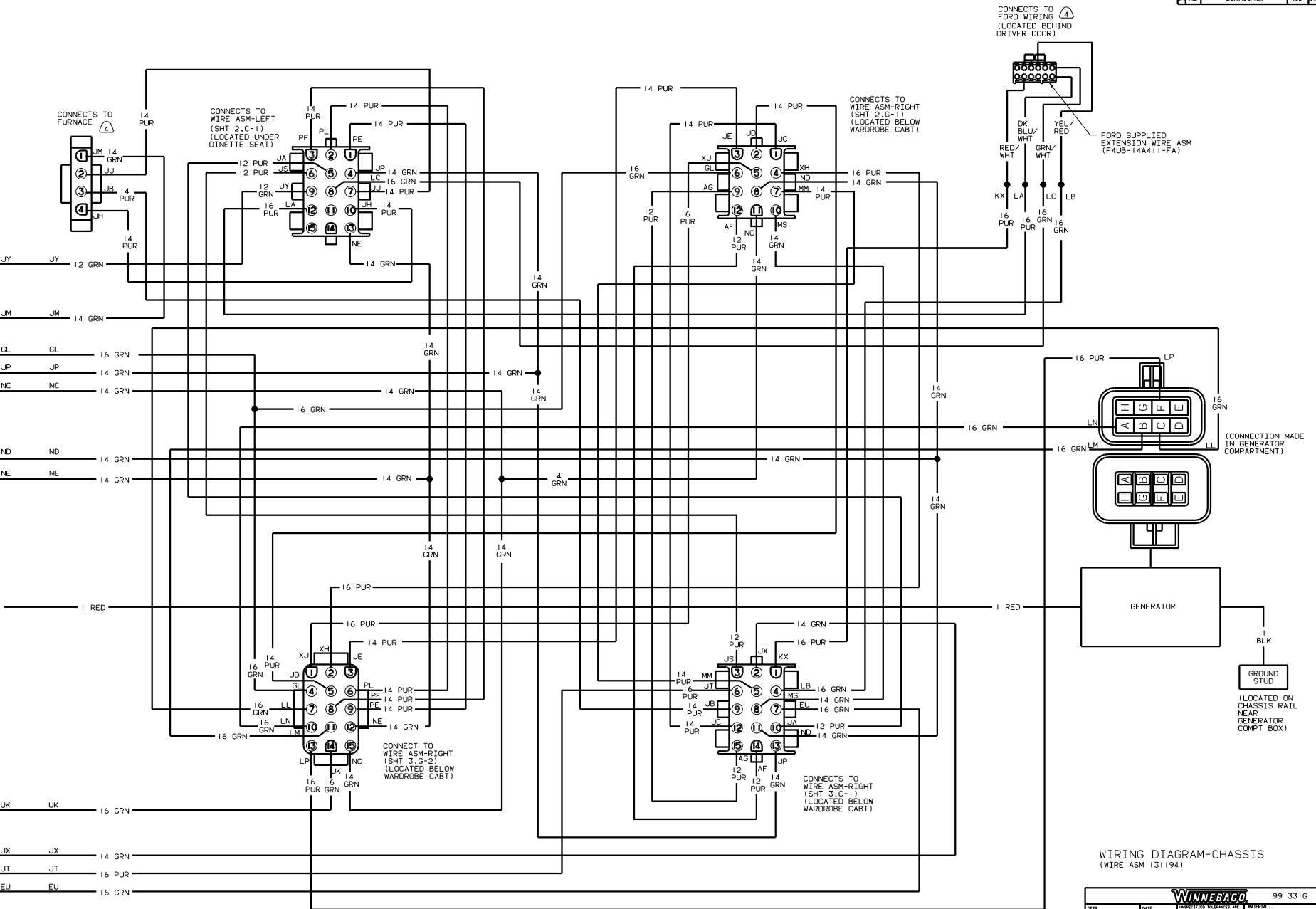

WIRING DIAGRAM-CHASSIS (WIRE ASM 131194)

		99 331G	
		WIRING DIAGRAM-BODY.12V	
DTR	DATE	INSPECTED TOLERANCES ARE:	MATERIAL: DO NOT SCALE DRAWING ALL DIMENSIONS ARE IN MILLIMETERS
OWP	DATE	WIRE GAUGE (MIL)	
P.T.E	DATE	INS-PLATE (0.001)	
P.F.E	DATE	INS-PLATE (0.001)	
DWR	DATE	INS-PLATE (0.001)	
REV	DATE	INS-PLATE (0.001)	
SHEET 1 OF 5		131178	

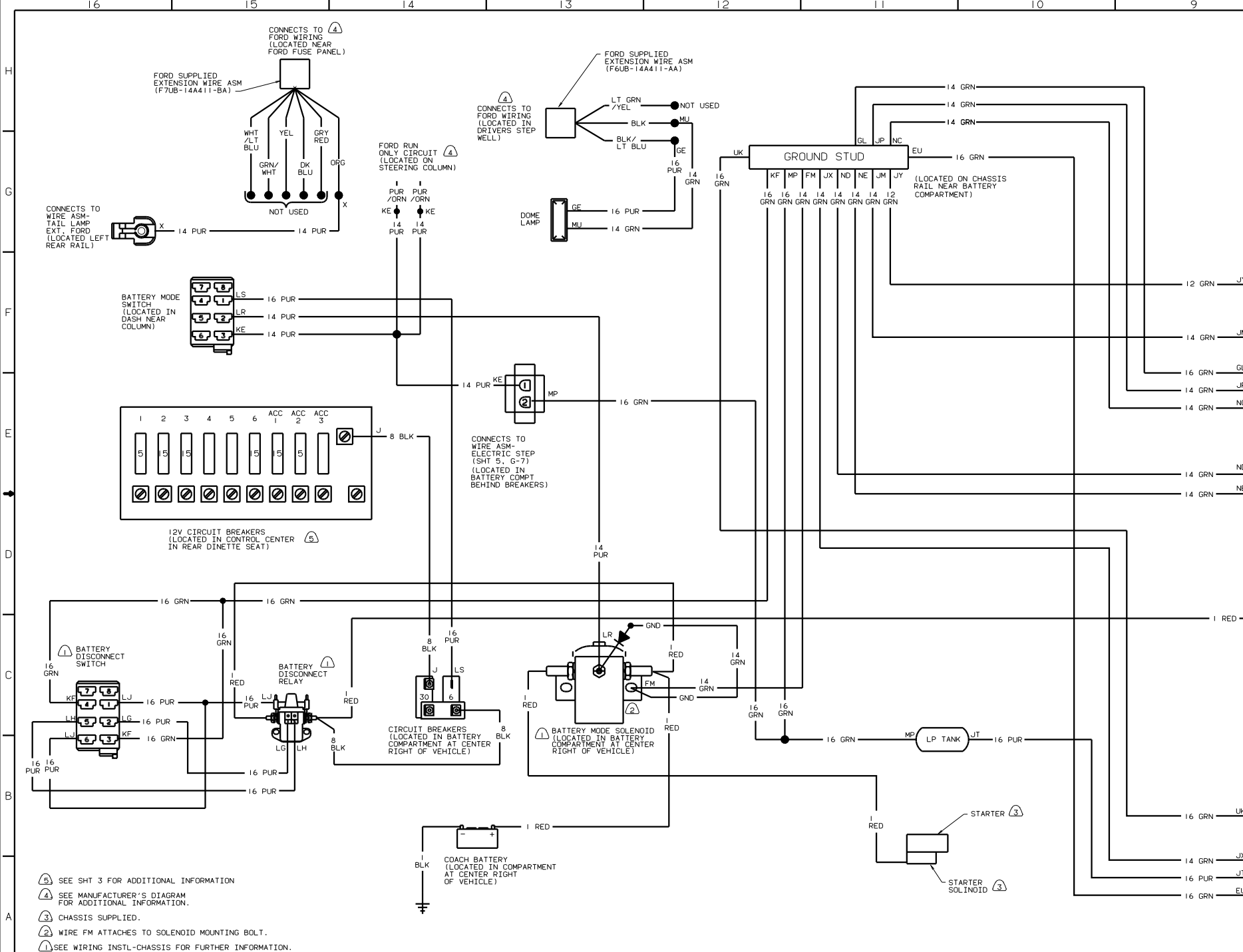

- (5) SEE SHT 3 FOR ADDITIONAL INFORMATION
 (4) SEE MANUFACTURER'S DIAGRAM FOR ADDITIONAL INFORMATION.
 (3) CHASSIS SUPPLIED.
 (2) WIRE FM ATTACHES TO SOLENOID MOUNTING BOLT.
 (1) SEE WIRING INSTL-CHASSIS FOR FURTHER INFORMATION.

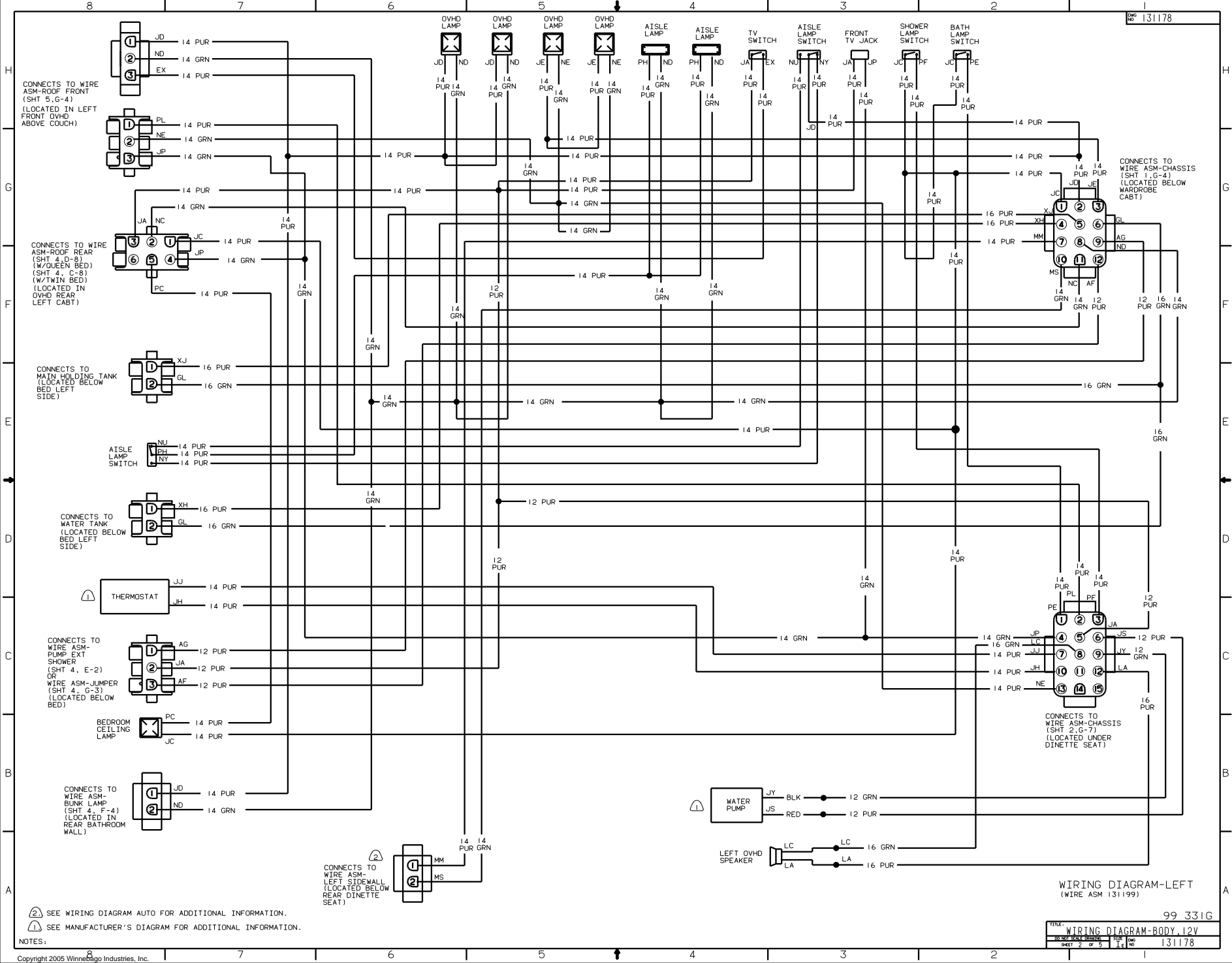

WIRING DIAGRAM-LEFT
(WIRE ASM 131199)

(2) SEE WIRING DIAGRAM AUTO FOR ADDITIONAL INFORMATION.
 (1) SEE MANUFACTURER'S DIAGRAM FOR ADDITIONAL INFORMATION.

99 331G	
TITLE: WIRING DIAGRAM-BODY 12V	
NO. OF SHEETS: 5	SHEET NO. 2
DATE: 1.6	REV. NO. 1
131178	

12V CIRCUIT BREAKERS
(LOCATED IN CONTROL CENTER
IN REAR DINETTE SEAT)

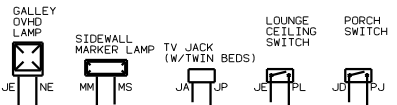
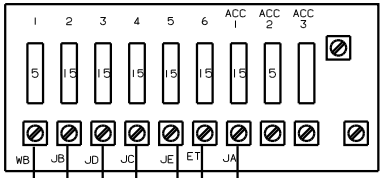

CONNECT TO LP DETECTOR
(LOCATED IN REFRIGERATOR CABT)

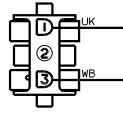

CONNECTS TO WIRE ASM-ROOF CENTER
(SHT 4, C-8)
(LOCATED IN WARDROBE CABT)

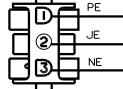
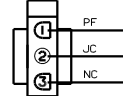

CONNECTS TO RANGE HOOD

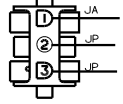
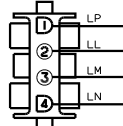

CONNECTS TO WIRE ASM-PORCH LAMP
(SHT 4, C-4)
(LOCATED IN OVHD GALLEY CABT)

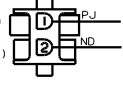

CONNECTS TO WIRE ASM-EXT ENT CENTER
(SHT 4, B-4)
(LOCATED IN GALLEY CABT)

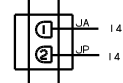

CONNECTS TO WIRE ASM-SDWL RIGHT
(SHT 4, A-8)
LOCATED IN WARDROBE CABT
(WATER HEATER COMPT)

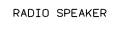
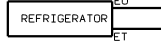
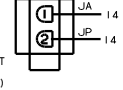

CONNECTS TO WATER HEATER
(LOCATED IN WARDROBE CABT)

CONNECTS TO AUX HOLDING TANK
(LOCATED BELOW BED CABINET)

CONNECTS TO WIRE ASM-CHASSIS
(SHT 1, C-7)
(LOCATED BELOW WARDROBE CABT)

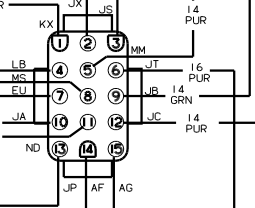
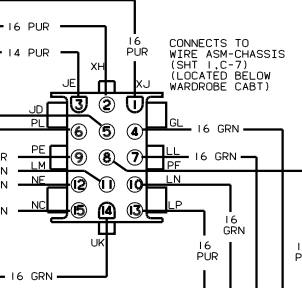

CONNECTS TO WIRE ASM-CHASSIS
(SHT 1, C-4)
(LOCATED BELOW WARDROBE CABT)

NOTES:
② SEE SHT 1 FOR ADDITIONAL INFORMATION.
⚠ SEE MANUFACTURER'S DIAGRAM FOR ADDITIONAL INFORMATION.

CONNECTS TO MONITOR PANEL

WIRING DIAGRAM-RIGHT
(WIRE ASM 131200) 99 331G

TITLE	WIRING DIAGRAM-BODY 12V
NO. OF SHEETS	5
SHEET NO.	3
REV.	1
DATE	131178

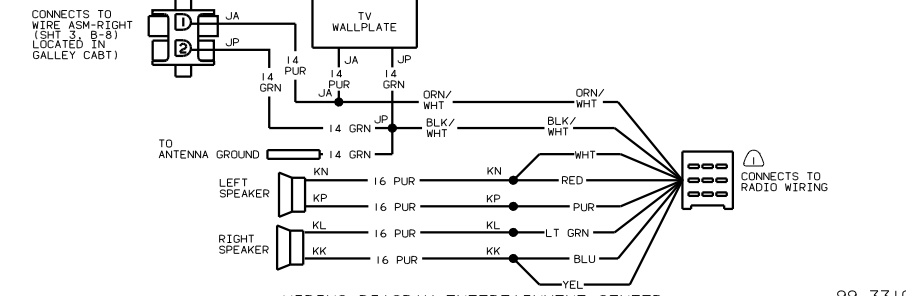
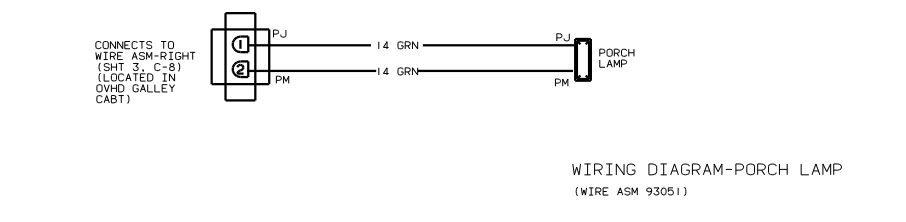
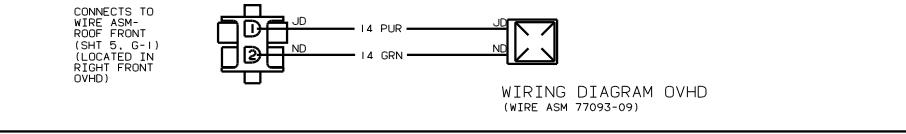
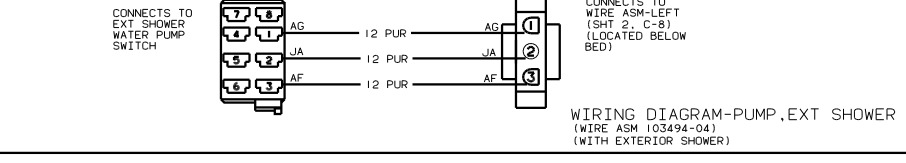
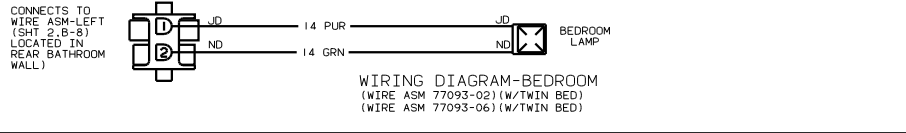
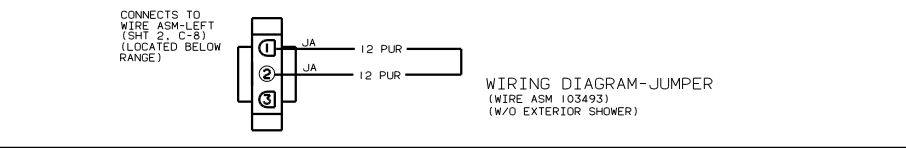
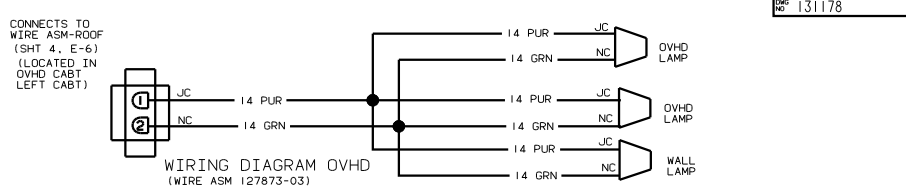
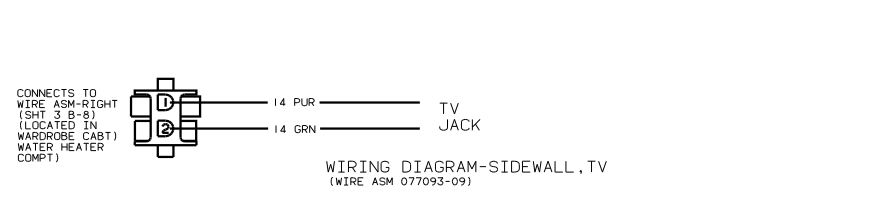
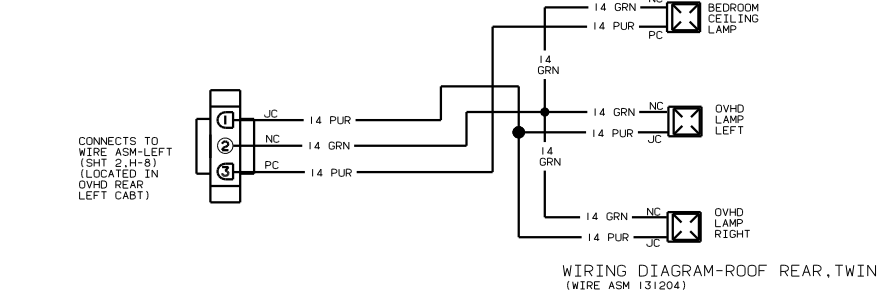
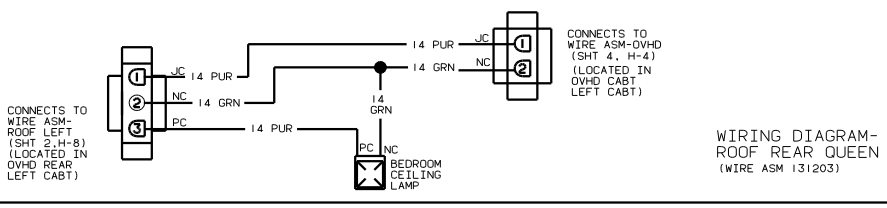
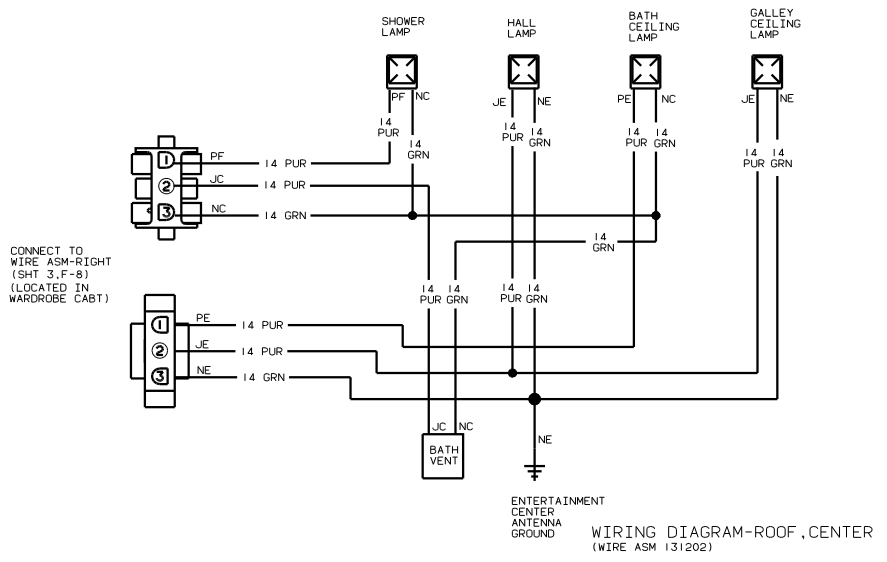

SEE MANUFACTURER'S DIAGRAM FOR ADDITIONAL INFORMATION.

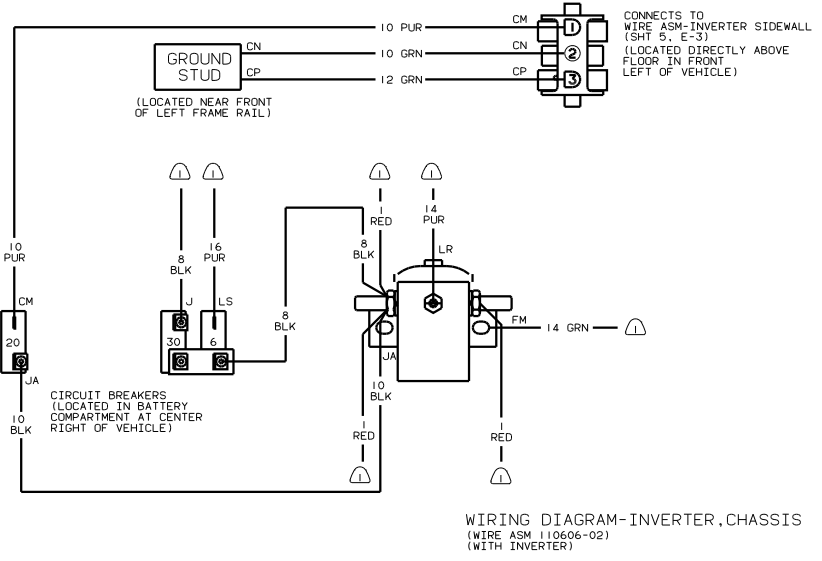
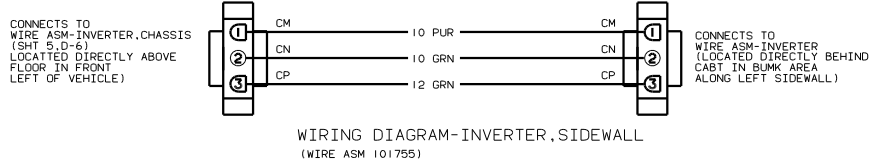
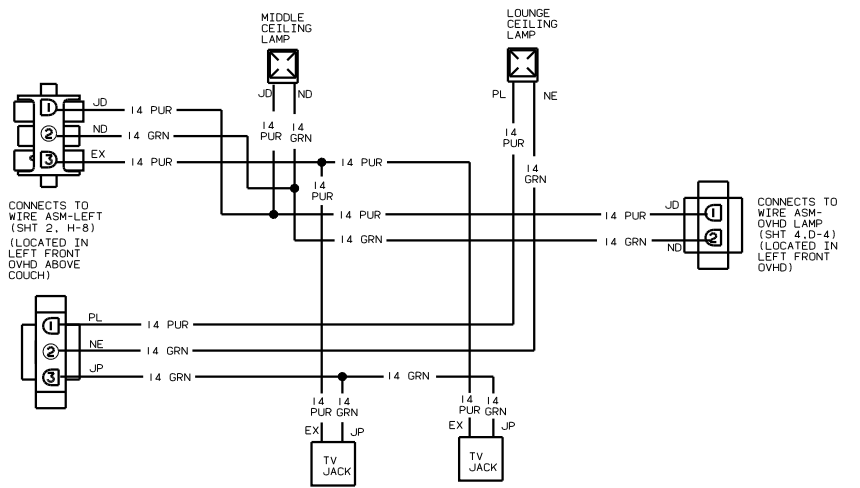
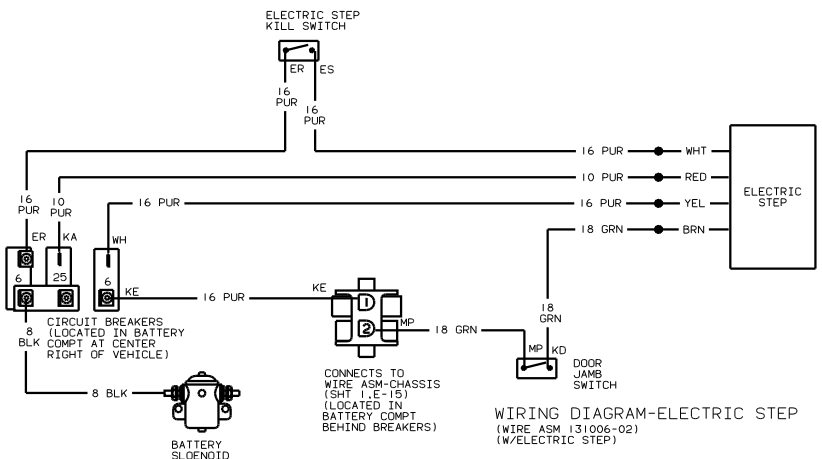

NOTES:
SEE SHT 1 FOR ADDITIONAL INFORMATION.