

- ③ TRIM P-TRAP EXTENSION TO FIT.
 - ⑧ SECURE VENT TUBES TO FLOOR.
 - ⑦ VENT PIPE MUST BE PROJECTED 51 TO 64 MAXIMUM ABOVE ROOF FOR PROPER FIT AND FUNCTION.
 - ⑥ SEE DRAWING 61607-01-000 FOR INSTALLATION OF GROMMET.
5. SEAL ALL AROUND SHOWER WITH SILICONE 78474-01-CHT.
 4. FOR CANADIAN UNITS EACH HOLDING TANK SHALL HAVE A CSA APPROVAL STAMPED NEAR TAPMO APPROVAL.
 3. ALL PIPE AND FITTINGS TO BE ASSEMBLED WITH SOLVENT 4020-01-000.
 2. SLOPE OF TRAP MUST BE 6 PER 300 MINIMUM.
 1. SLOPE OF HORIZONTAL PIPING TO BE 6 PER 300 MINIMUM.

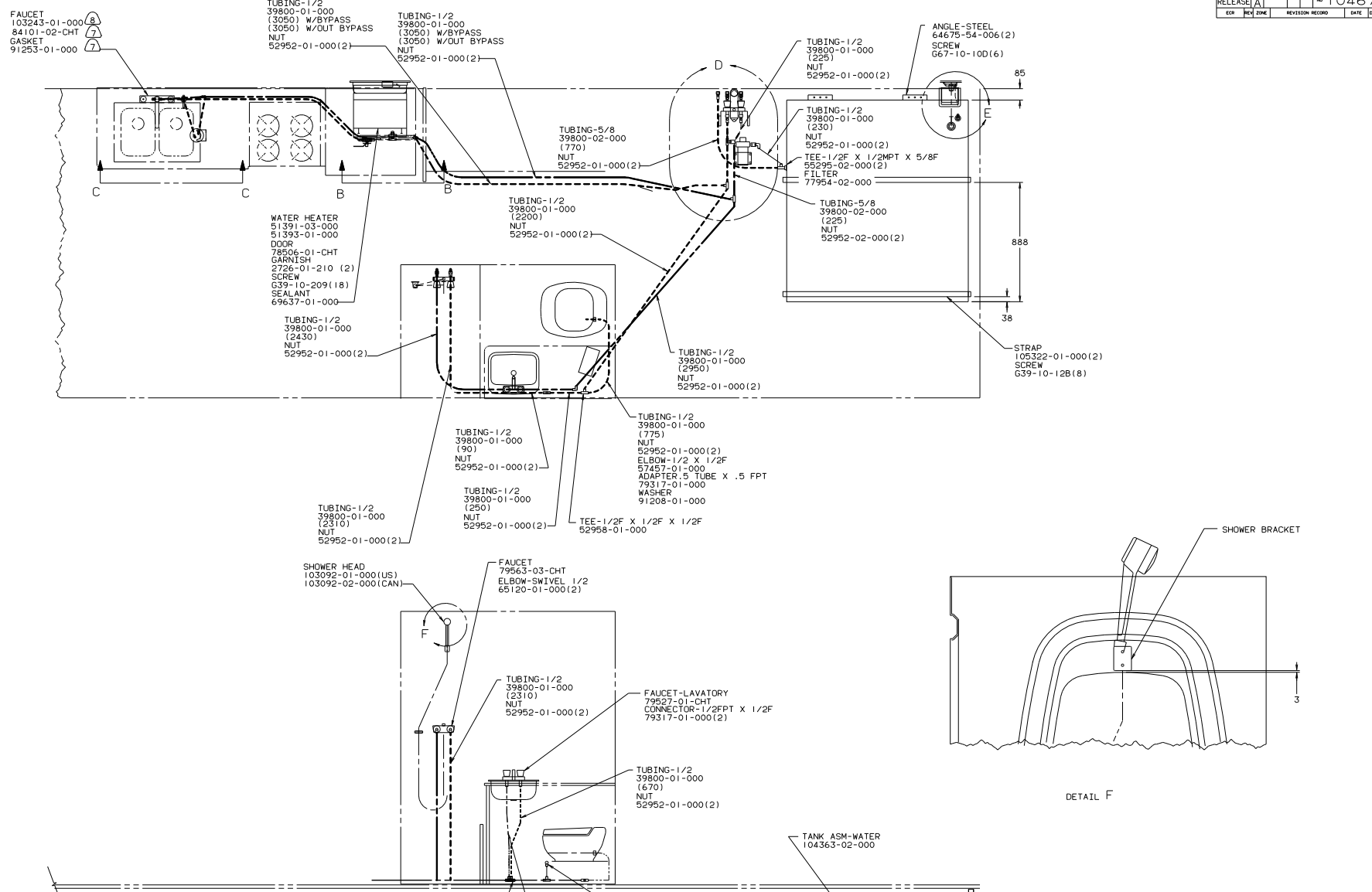

- ⑩ USE WITHOUT MOTOR AID.
 - ⑨ USE WITH MOTOR AID.
 - ⑧ USE WITH DOUBLE CONTROL FAUCET.
 - ⑦ USE WITH SINGLE CONTROL FAUCET.
 - ⑥ USE WITHOUT EXTERIOR SHOWER.
 - ⑤ USE WITH EXTERIOR SHOWER.
 - ④ LOCATE LUMBER TO SUPPORT WATER HEATER.
3. ALL TUBING TO BE SECURED AT 1200 INTERFALS MAX WITH CLIP 91951-01-000 AND SCREW G13-06-16U.
2. TUBING TO BE INSTALLED WITH SUFFICIENT SLOPE TO PROVIDE DRAINAGE TO NEAREST VALVE.
1. PLASTIC FITTINGS TO BE SEALED WITH SEALANT 84456-01-000.

VIEW A-A

DETAIL F

LEGEND

HOT	-----
COLD	-----

WINNERAG 92 WCG34R0

DATE	UNSPECIFIED TOLERANCES ARE:	MATERIAL
CHG	WHOLE DIM (IN)	1/16
REV	ONE-PLACE (IN, IN)	1/32
REV	TWO-PLACE (IN, IN)	1/64
REV	ANGLE	1/16
REV	THIRD ANGLE PROJECTION	

LAND # G34R02 TITLE: WATER SYSTEM INSTL
 DIA # SCALE: NONE 30.000 SCALE DRAWING SIZE: 11.000
 ALL DIMENSIONS ARE IN MILLIMETERS SHEET 1 OF 3 104674

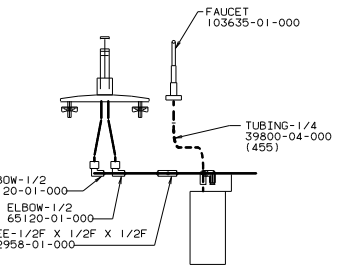
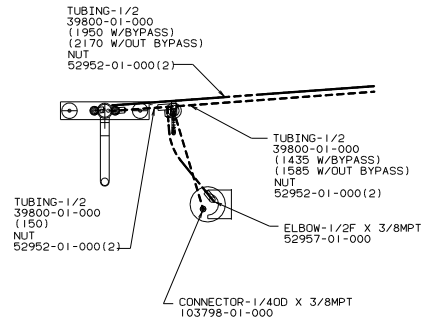

VIEW C-C
(WITH PURIFIER AND FAUCET)

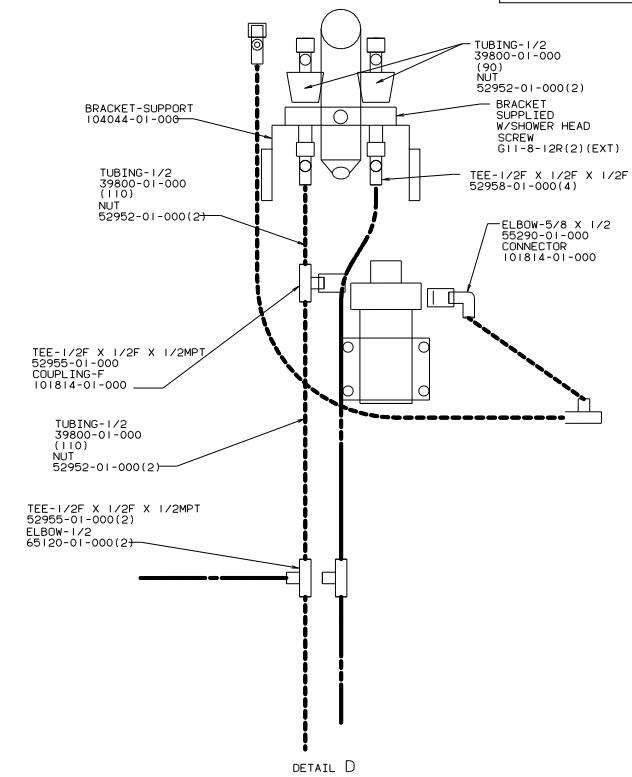
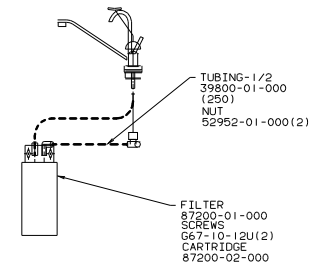

DETAIL D

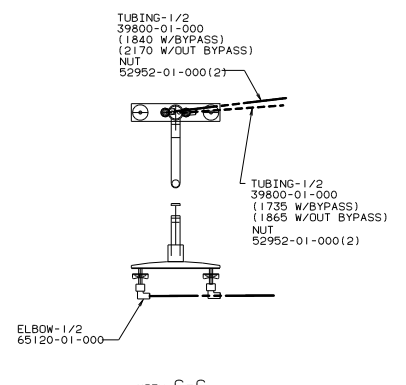

VIEW C-C
(W/OUT PURIFIER)

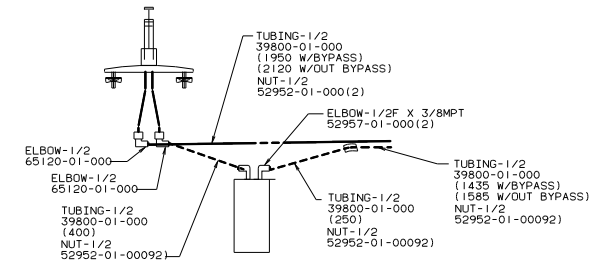

VIEW C-C
(WITH PURIFIER)

