

OUTLOOK

TABLE OF CONTENTS

1 – INTRODUCTION

About this Manual	1-1
Safety Messages Used in this Manual	1-1
Pre-Delivery Inspection	1-2
Front Axle Tire Alignment	1-2
Service and Assistance	1-2
Reporting Safety Defects	1-2
Occupant and Cargo Carrying Capacity Label	1-3
Vehicle Certification Label	1-4
specifications and Capacities	1-5
Owner and Vehicle Information	1-6
2010 New Vehicle Limited Warranty	1-7

2 – SAFETY AND PRECAUTIONS

General Warnings	2-1
Driving Safety	2-1
Fuel and Propane Gas	2-1
LP Gas Leaks	2-2
Propane Gas Leak Detector	2-2
Carbon Monoxide Warning	2-3
Carbon Monoxide Alarm	2-3
Smoke Alarm	2-4
Fire Extinguisher	2-4
Electrical	2-5
Loading	2-5
Maintenance	2-5
Emergency Exits	2-5
Slideout Rooms	2-6
Formaldehyde Information	2-7
Mold, Moisture, and Your Motor Home	2-7
Roof and Ladders	2-8
Roadside Emergency	2-9
Jump Starting	2-10
Engine Overheat	2-10

3 – DRIVING YOUR MOTOR HOME

Seats – Driver/Co-Pilot	3-1
Fold-Down Dinette Seat	3-1
Seat Belts	3-1
Child Restraints	3-2
Keys	3-3

KeyOne™ Lock System	3-3
Hazard Warning Flashers	3-3
Mirrors – Power sideview Exterior	3-4
Battery Boost Switch	3-4
Air Conditioner/Heater – Automotive (Dash)	3-5
Radio In-Dash/Rearview Monitor System	3-5
Radio – In-Dash	3-6
Sirius® Plug and Play Satellite Radio	3-8
Engine Access – Interior	3-9
Engine Cooling System	3-9
Tires	3-9
Suspension Alignment and Tire Balance	3-9
Air Springs – Rear Helper	3-10
Lights	3-10
Mountain Driving	3-10
 4 – APPLIANCES AND SYSTEMS	
Refrigerator	4-1
Refrigerator Service Access Compartment	4-2
Range Top	4-2
Microwave Oven/Range Hood	4-3
Systems Monitor Panel	4-4
Water Heater – Gas	4-5
Water Heater - Gas/ Electric	4-5
MotorAid Water Heater	4-6
Pressure-Temperature Relief Valve	4-7
Propane Gas Furnace	4-8
Furnace-A/C Thermostat Operation Chart	4-9
Heat Pump	4-9
Ducted Roof Air Conditioning System	4-10
Air Conditioner Filter	4-10
 5 – PROPANE GAS	
Propane Gas Supply	5-1
Safe Use of the Propane Gas System	5-2
Propane Gas Warnings and Precautions	5-3
Propane Gas Pressure Regulator	5-4
Propane Vaporization in Cold Weather	5-5
 6 – ELECTRICAL	
Electrical Cautions	6-1
Electrical System – House 120-Volt AC	6-1
External Power Cord	6-1
Power Center	6-2
Circuit Breakers – House 120-Volt AC	6-3
Electrical Outlets – House 120-Volt AC	6-3

Ground Fault Circuit Interrupter	6-3
Electrical Generator – 120-Volt	6-4
Electrical System – House 12-Volt DC	6-5
House Battery Disconnect Switch	6-6
Battery Access	6-6
Battery Care	6-6
Circuit Breakers and Fuses – House 12-Volt	6-8
7 – PLUMBING	
Fresh Water System	7-1
Water Pump	7-2
Cold Water Filter	7-3
Disinfecting Your Fresh Water System	7-4
Shower Hose Vacuum Breaker	7-5
Exterior Shower/Wash Station	7-5
Toilet	7-5
Waste Water System	7-6
Holding Tank Heater	7-7
WaterLine & Tank Drain Valves	7-7
Water Heater Bypass Valve	7-8
Winterizing Procedures	7-9
Winterizing Optional Appliances	7-14
Water System Drain Valve Locations	7-16
8 – ENTERTAINMENT	
Video Selection System	8-1
Front TV Ignition Switch Interlock	8-2
Swing-Out TV Mounts	8-2
TV/DVD Master Power Switch (12-Volt)	8-2
TV - Removable (Interior/Exterior)	8-2
Audio-Video System Basic Operation	8-5
DVD Home Theater System	8-5
DVD Player	8-6
Electrical Inverter	8-7
TV Antenna	8-7
TV Signal Amplifier	8-8
Cable TV Hook-Up	8-9
TV Digital Satellite System – Manual	8-9
Exterior Entertainment Center	8-9
9 – FURNITURE AND SOFTGOODS	
Sleeping Facilities	9-1
Front Overhead Bunk	9-1
Sofa/Bed Conversion	9-2
Dinette/Bed Conversion	9-2
Dinette/Bed Conversion	9-3

U-Shaped Dinette/Bed Conversion	9-4
Sofa Air Bed (Comfort Sofa Sleeper)	9-5
Pleated Blinds	9-8
Wood Furniture and Cabinetry	9-9
10 – SLIDEOUT ROOMS AND LEVELING	
Slideout Room Travel Lock	10-1
Slideout Room Operation – Electric	10-2
Slideout Room – Extreme Weather Precaution	10-4
Slideout Room Troubleshooting – Electric	10-4
Slideout Emergency Retraction – Electric	10-6
Slideout Emergency Retraction - Bedroom	10-8
General Slideout Care	10-9
Leveling System	10-9
Checking Hydraulic Oil Level	10-11
11 – MAINTENANCE AND STORAGE	
Sealants – Inspection and General Information	11-1
Roof	11-1
Undercarriage	11-1
Exterior Automotive Paint Finish	11-2
Care of Appliques and Decals	11-4
Plastic Parts – Cleaning	11-4
Exterior Lights	11-5
Interior Soft Goods	11-5
Ceiling Fabric Care	11-6
Cabinetry – Cleaning	11-7
Tables and Countertops	11-8
Galley Sink	11-8
Range and Refrigerator	11-8
Bathroom	11-8
Doors and Windows	11-9
Vehicle Storage – Preparation	11-9
Vehicle Storage – Removal	11-10
Coach Maintenance Chart	11-12
12 – MISCELLANEOUS	
Loading the Vehicle	12-1
Weighing Your Loaded Vehicle	12-1
Car or Trailer Towing	12-3
Trailer Wiring Connector	12-4
Towing Guidelines	12-4
Entry Step – Manual	12-5
Entry Step – Electric	12-6
Windows	12-7
Power Roof Ventilator	12-7

OUTLOOK

Manual Awning	12-8
Storage Compartment Doors	12-8
Tool and Ladder Storage	12-8
Roof Ladder	12-9
Effects of Prolonged Occupancy	12-9

OUTLOOK

SECTION 1 – INTRODUCTION

Congratulations! We welcome you to the exciting world of motor home travel and camping. You will find it convenient and enjoyable to have all the comforts of home and still enjoy the great outdoors wherever you choose to go. Your motor home has been carefully designed, engineered, and manufactured to provide years of enjoyment.

Before sliding into the driver's seat, please become familiar with operations and features. In addition, spend some time with the dealer when you take delivery to learn all you can about your new motor home.

ABOUT THIS MANUAL

This operator's manual was prepared to aid you in the proper care and operation of the vehicle and equipment.

Please read this manual completely to understand how everything in your coach works before taking it on its "maiden voyage".

NOTE: This manual describes many features of your motor home and includes instructions for its safe use.

This manual, including photographs and illustrations, is of a general nature only.

Some equipment and features described or shown in this manual may be optional or unavailable on your model.

Because of Winnebago Industries[®], continuous program of product improvement, it is possible that recent product changes and information may not be included.

The instructions included in this manual are intended as a guide, and in no way extend the responsibilities of Winnebago Industries beyond the standard written warranty as presented in this manual.

The descriptions, illustrations, and specifications in this manual were correct at the time of printing. We reserve the right to change specifications or

design without notice, and without incurring obligation to install the same on products previously manufactured.

The materials in your InfoCase contain warranty information and operating and maintenance instructions for the various appliances and components in your motor home.

NOTE: Many of the instruction sheets and manuals for the various appliances and components have been incorporated into the Operator's Manual Supplement for your convenience.

Please read the FAQ in Section 1 of the Operator's Manual Supplement for more details.

Throughout this manual, frequent reference is made to the vehicle chassis manual that is provided by the manufacturer of the chassis on which this motor home is built.

Consult the chassis manual for operating, safety, and maintenance instructions pertaining to the chassis section of the motor home.

SAFETY MESSAGES USED IN THIS MANUAL

Throughout this manual, certain items are labeled Danger, Warning, Caution, or Note. These terms alert you to precautions that may involve damage to your vehicle or a risk to your personal safety. Read and follow them carefully.



DANGER indicates a hazardous situation which, if not avoided, will result in death or serious personal injury.



WARNING

WARNING indicates a hazardous situation which, if not avoided, could result in death or serious personal injury.



CAUTION

CAUTION indicates a hazardous situation which, if not avoided, could result in minor or moderate personal injury.

NOTICE

NOTICE is used to address practices not related to personal injury.

NOTE: A “Note” is not necessarily safety-related, but indicates a recommendation or special point of information that could assist in understanding the use or care of a feature item.

PRE-DELIVERY INSPECTION

This motor home has been thoroughly inspected before shipment. Your dealer is responsible for performing a complete pre-delivery inspection of the chassis and all motor home components.

As a part of the pre-delivery inspection procedure, the dealer is responsible for road testing the motor home, noting, and correcting any problems before delivery.

**FRONT AXLE TIRE
ALIGNMENT**

We recommend that you have the front suspension and steering alignment checked and adjusted after you have fully loaded the vehicle

according to your needs. Thereafter, have alignment inspected periodically to maintain vehicle steering performance and prevent uneven tire wear.

SERVICE AND ASSISTANCE

Your dealer will be glad to provide any additional information you need, as well as answer any questions you might have about operating the equipment in your motor home. When it comes to service, remember that your dealer knows your vehicle best and is interested in your satisfaction. Your dealer will provide quality maintenance and any other assistance that you may require during your ownership of this vehicle.

If you need warranty repairs while traveling, you may take your motor home to any authorized Winnebago Industries® dealership and request their assistance.

See the Motor Home Service Dealer Directory in your InfoCase.

REPORTING SAFETY DEFECTS

If you believe that your vehicle has a defect which could cause a crash or could cause injury or death, you should immediately inform the National Highway Traffic Safety Administration (NHTSA) in addition to notifying Winnebago Industries, Inc.

If NHTSA receives similar complaints, it may open an investigation, and if it finds that a safety defect exists in a group of vehicles, it may order a recall and remedy campaign. However, NHTSA cannot become involved in individual problems between you, your dealer, or Winnebago Industries®.

To contact NHTSA, you may either call the Vehicle Safety Hotline toll-free at:

1-888-327-4236; (TTY: 1-800-424-9153)

or go to their website at <http://www.safercar.gov> or write to:

Administrator, NHTSA
1200 New Jersey Avenue S.E.
Washington, D.C. 20590

You can also obtain other information about motor vehicle safety from the NHTSA website at <http://www.safercar.gov>

OCCUPANT AND CARGO CARRYING CAPACITY LABEL

This label is affixed in the driver's area next to or near the Vehicle Certification Label. It contains vehicle occupant and cargo carrying capacity along with the number of seat belt positions in the vehicle. The label also provides the weight of a full load of water and advises that this weight, along with the tongue weight counts as cargo.

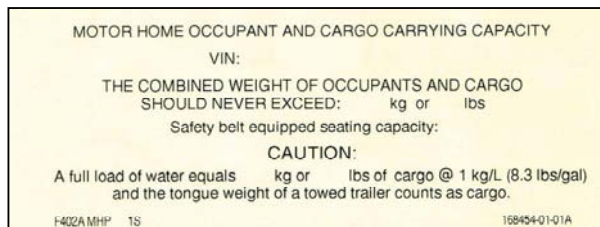

If any weight exceeding 45.4 kg (100 lbs.) is added to your coach between final vehicle certification and first retail sale, the occupant and cargo carrying capacity must be corrected and a label similar to the one shown below will be affixed inside your coach.



VEHICLE CERTIFICATION LABEL

This label is affixed to the lower driver side armrest panel, driver door, or the driver side door jamb, depending on model. It contains vehicle identification numbers and other important reference information.

MANUFACTURED BY WINNEBAGO IND. INC.	3	INCOMPLETE VEHICLE MANUFACTURED BY GVWR	1	4	LB	2	KG
GAWR: FRT	5	LB	KG	SUITABLE TIRE AND RIM CHOICE TIRE		COLD INFLATION PRESSURE	
RR	6	LB	KG	7	RIM	8	9
						PSI	KPA
						PSI	KPA

THIS VEHICLE HAS BEEN COMPLETED IN ACCORDANCE WITH THE PRIOR MANUFACTURER'S IVD, WHERE APPLICABLE. THIS VEHICLE CONFORMS TO ALL APPLICABLE FEDERAL MOTOR VEHICLE SAFETY STANDARDS IN EFFECT ON THE DATE OF MANUFACTURE SHOWN ABOVE.

SERIAL NO.	10	VIN	11	TYPE	12	COLOR	13
	XXXXX XXXX XX XX/XX/XX XXX-XXXXX		14		15		XXXXXX-XXX

EXPLANATION OF DATA

1. Chassis manufacturer.
2. Chassis manufacture date.
3. Month and year of manufacture at Winnebago Industries®.
4. Gross Vehicle Weight Rating: Total permissible weight of the vehicle, including driver, passengers, total cargo carried (including all liquids), and equipped with all options.
5. Gross Axle Weight Rating: Total permissible weight allowed for the front and rear axles (listed in pounds and kilograms).
6. Suitable Tire Choice: Tires recommended to meet handling and safety requirements. When replacing any of the tires on your vehicle, always replace with a tire that meets these specifications.
7. Suitable Rim Choice: Wheel rims recommended to meet handling and safety requirements. When replacing any of the rims on your vehicle, always replace with a rim that meets these specifications.
8. Cold Inflation Pressure: Inflation pressures at Gross Axle Weight Ratings recommended (while cold) for the tires originally equipped on your vehicle. These pressure levels must be maintained to assure proper handling, safety, and fuel economy.
9. Rear Axle Wheel Configuration: Single or Dual as it relates to the inflation.
10. Serial Number: This is the serial number assigned to the completed vehicle by Winnebago Industries.
11. Vehicle Identification Number (VIN): This number identifies the chassis on which the motor home is built. The 10th digit of the VIN designates the chassis model year. (7=2007, 8=2008, etc.). This information is useful when ordering chassis repair parts.
12. Type: States the NHTSA designated usage classification for your motor home. MPV signifies a Multi-purpose Passenger Vehicle.
13. Color: Signifies the color code number of the decor used throughout the vehicle. This number is necessary for ordering replacement cushions, curtains, carpet, etc.
14. Winnebago® model year and series/family name.
15. Model: Lists the Winnebago product model number of your vehicle.

SPECIFICATIONS AND CAPACITIES

Winnebago Outlook	29B	31C
	Ford® E450 Chassis	Ford® E450 Chassis
Length	29' 9"	31' 2"
Exterior Height ¹	11' 5"	11' 5"
Exterior Width ⁶	8' 5"	8' 5"
Exterior Storage ²	54.3 cu. ft.	32.9 cu. ft.
Awning Length	18'	15'
Interior Height	6' 8"	6' 8"
Interior Width	8'	8'
Freshwater Capacity ³	36 gal.	37 gal.
Water Heater Capacity	6 gal.	6 gal.
Optional Water Heater Capacity	6 gal.	6 gal.
Holding Tank Capacity - Black ³	30 gal.	35 gal.
Holding Tank Capacity - Gray ³	39 gal.	33 gal.
LP Capacity ⁴	18 gal.	18 gal.
Fuel Capacity	55 gal.	55 gal.
GCWR ⁵	20,000 lbs.	20,000 lbs.
GVWR	14,500 lbs.	14,500 lbs.
GAWR - Front	5,000 lbs.	5,000 lbs.
GAWR - Rear	9,500 lbs.	9,500 lbs.
Wheelbase	190"	220"

Notes:

All measurements are based upon the most recent data available. See your dealer for specifications.

¹ The height of each model is measured to the top of the tallest standard feature and is based on the curb weight of a typically equipped unit. The actual height of your vehicle may vary by several inches depending on chassis or equipment variations. Contact your dealer for further information.

² The load capacity of your motor home is designated by weight, not by volume, so you cannot necessarily use all available space when loading your motor home.

³ Capacities are based on measurements prior to tank installation. Slight capacity variations can result upon installation.

⁴ Capacities shown are the tank manufacturer's listed water capacity (W.C.). Actual filled propane capacity is 80% of listing due to overfilling prevention device on tank.

⁵ Actual towing capacity is dependent on your particular loading and towing circumstances which includes the GVWR, GAWR, and GCWR as well as adequate trailer brakes. Refer to the chassis operator's manual of your motor home for further towing information.

⁶ Floorplans feature a wide-body design - over 96". You should be aware that some states restrict access on some or all state roads to 96" in body width. You should confirm the road usage laws in the states of interest to you.

OWNER AND VEHICLE INFORMATION

OWNER INFO

Owner's Name(s) _____

Address _____

VEHICLE INFORMATION

Motor Home Model Number _____

Motor Home Serial Number _____

Chassis Vehicle Identification No. (VIN) _____

Vehicle Mileage at Delivery _____

Selling Dealer Name _____

Address _____

YOUR WINNEBAGO INDUSTRIES® DEALER /SERVICE CENTER

Name _____

Address _____

Contact _____ Phone _____

CHASSIS SERVICE CENTER

Name _____

Address _____

Contact _____ Phone _____

RV INSURANCE POLICY

Company _____

Policy Number _____

Agent _____ Phone _____

2010 NEW VEHICLE LIMITED WARRANTY WINNEBAGO INDUSTRIES, INC.



WARRANTY COVERAGE TO OWNER

Winnebago Industries, Inc. of Forest City, Iowa, warrants each new Winnebago and Itasca motor home to the owner for recreational use in the U.S.A. and Canada as follows:

BASIC LIMITED WARRANTY

WINNEBAGO INDUSTRIES' RESPONSIBILITY

Any part of the vehicle subject to this warranty that is found to be defective in material or workmanship under normal use and maintenance will be repaired or replaced at Winnebago Industries' option without charge to the customer for parts or labor upon notice of the defect.

WARRANTY PERIOD

The basic Warranty Period is 12 months or 15,000 miles (24,135 kilometers), on the odometer, whichever occurs first. The Warranty Period for all coverages begins on the date the vehicle is delivered to the first retail purchaser or first placed in service as a demonstrator or company vehicle.

ONLY WARRANTY

This limited warranty is the only warranty made or authorized by Winnebago Industries. Winnebago Industries makes no other promises, representations or warranties concerning the vehicle or other matters set forth herein. Winnebago Industries does not authorize any person to create for it any other obligations or liability in connection with this vehicle.

DEALER'S REPRESENTATIONS EXCLUDED

Winnebago Industries shall not be bound by any undertaking, representation, or warranty made by any dealers selling its product to any purchaser of its products.

EXCLUSIVE REMEDY

THE PERFORMANCE OF REPAIRS IS THE EXCLUSIVE REMEDY UNDER THIS LIMITED WARRANTY OR ANY IMPLIED WARRANTY. ANY IMPLIED WARRANTY OF MERCHANTABILITY OR FITNESS FOR A PARTICULAR PURPOSE APPLICABLE TO THIS VEHICLE ARISING BY WAY OF STATE LAW IS LIMITED IN DURATION TO THE DURATION OF THIS WRITTEN WARRANTY AS HEREINBEFORE OR HEREINAFTER PROVIDED.

LIMITATION ON LIABILITY

WINNEBAGO INDUSTRIES SHALL NOT BE LIABLE FOR INCIDENTAL OR CONSEQUENTIAL DAMAGES RESULTING FROM BREACH OF THIS WRITTEN WARRANTY OR ANY IMPLIED WARRANTY. SUCH DAMAGES INCLUDE, BUT ARE NOT LIMITED TO, LOSS OF TIME, INCONVENIENCE, OR OTHER CONSEQUENTIAL DAMAGE INCLUDING EXPENSE FOR GASOLINE, TELEPHONE, TRAVEL, LODGING, LOSS OR DAMAGE TO PERSONAL PROPERTY, OR LOSS OF REVENUE. Some states do not allow limitations on how long an implied warranty will last or the exclusion or limitation of incidental or consequential damages, so the above limitations or exclusions may not apply to you.

ITEMS NOT SUBJECT TO WARRANTY COVERAGE

Chassis, drivetrain and related components*
Wheels*
Tires*
Any other part or component covered by a written warranty issued by its manufacturer*
Service Items, such as Windshield Wiper Blades, Lubricants, Fluids & Filters
Adjustments
Rust and Corrosion

*These items are covered under the manufacturer's individual warranty.

ADDITIONAL EQUIPMENT NOT COVERED

Winnebago Industries cannot and does not accept any responsibility in connection with any of its motor homes for additional equipment or accessories installed at any dealership or other place of business, or by any other party other than Winnebago Industries. Such installation of equipment or accessories by any other party will not be covered by the terms of this warranty.

36 MONTH/36,000 MILE STRUCTURAL WARRANTY

At the expiration of the Basic Coverage and for the remainder of the period of 36 months or 36,000 miles (57,924 kilometers), on the odometer, whichever occurs first, Winnebago Industries warrants the following:

1. Structural defects of the subfloor, floor, and slide-out room. Floor lamination failure and lamination failure of the subfloor panels and risers are covered by the structural warranty.
2. Body Thermo-Panel® Lamination of the sidewalls and backwall against delamination. Body Thermo-Panel® Lamination is the bonding of the exterior skin and the interior paneling to an insulating core material. Delamination (separation of layers) caused by other factors such as physical damage or failed sealants is not covered by this warranty.

This warranty gives you specific legal rights and you may also have other rights which vary from state to state.

Also, this warranty shall not apply to failures, damage or malfunctions resulting from normal wear, misuse, abuse, negligence, alteration, accident, fire, improper repair of the vehicle or failure to follow recommended maintenance requirements.

OWNER'S RESPONSIBILITY-CARE AND MAINTENANCE

It is the owner's responsibility to perform the care, maintenance and proper load distribution described in the operator's manual which accompanies your motor home. Any damage which results to your vehicle as a result of your failure to perform such duties, is not covered.

Damage to appearance items such as fiberglass, metal, paint, fabrics and trim, may occur during manufacturing or transporting. Normally, any factory defect or damage is corrected at the factory. In addition, dealers are obligated to inspect each vehicle upon delivery to them and prior to delivery to you. You should also immediately inspect appearance items and advise your selling dealer of any discrepancies. Damage and deterioration due to use and exposure, such as rust or corrosion is not covered by this warranty.

OBTAINING WARRANTY REPAIRS

While any Winnebago Industries motor home dealer can perform warranty service, we recommend you return to the dealership that sold you your vehicle. If you are touring or have moved, contact any Winnebago Industries motor home dealer in the United States or Canada for warranty service.

If a part of the system covered by this limited warranty fails to function or requires service during the warranty period:

1. Promptly take the vehicle to the selling dealer for repair or inspection.
2. Written notice of defects must be given to the selling dealer and manufacturer.
3. If the dealer is incapable of making the repairs, request that he contact Winnebago Industries, Inc.
4. If, after the above steps are completed and the repair is not made, the customer should contact Winnebago Industries, Inc., 605 West Crystal Lake Road, P.O. Box 152, Forest City, Iowa 50436, Attention: Owner Relations Department (800-537-1885) and furnish the following information:
 - The complete serial number of the vehicle
 - Date of retail purchase
 - Selling dealer's name
 - Nature of the service problem, and a brief explanation of the steps or service the dealer has performed, and the results obtained. The customer may be directed to another dealer or service center for repairs to be completed, if such a dealer or service center is better able to complete the repair.

Winnebago Industries may, at its option, request the vehicle be returned to Forest City, Iowa for repair. If the customer refuses to allow repairs to be performed at the Forest City, Iowa facility, the warranty on that repair will be voided.

5. If after the above steps are completed and the repairs are not satisfactory, the customer may contact the Service Administration Manager of Winnebago Industries, and request a customer relations board meeting to resolve the problem. This action, however, is not mandatory.
6. Certain components are covered by warranties provided by individual component manufacturers. Please refer to the component's information supplied in the vehicle's InfoCase.

COMMENCEMENT OF ACTIONS

Any action for breach of The Basic Limited or Structural Warranty or any implied warranty shall be commenced within one-year after expiration of the warranty.

CHANGES IN DESIGN

Winnebago Industries, Inc. reserves the right to make changes in design and changes or improvements upon its products without imposing any obligation upon itself to install the same upon its products theretofore manufactured.

NEW YORK:

If your motor home has been repaired three or more times for the same nonconformity, defect, or condition, or if your motor home has been out of service by reason of repair for twenty-one days, Section 198-a of the General Business Law of the State of New York requires you to provide written notice by certified mail, return receipt requested, to Winnebago Industries or its authorized dealer before making any claim under that section of the law. If you do have problems with your motor home, you should provide written notice to Winnebago Industries at the following address:

Winnebago Industries, Inc.
605 West Crystal Lake Road
P.O. Box 152
Forest City, Iowa 50436

Attn: Owner Relations

CALIFORNIA:

Winnebago Industries participates in the Consumer Arbitration Program for Recreation Vehicles (CAP-RV). This third-party dispute resolution program is available, at no charge to you, to settle unresolved warranty disputes for recreational vehicles. This dispute resolution program reviews eligible product and service related complaints involving warranty covered components.

To find out more about the program, or to request an application/brochure, please call the Arbitration Administration office toll-free 800-279-5343.

The CAP-RV program operates as a certified mechanism under the review of the California Arbitration Certification Program. You must utilize the arbitration program before claiming rights conferred by 15 USC section 2310 (Uniform Commercial Code) or Civil Code section 1793.22(b) (Tanner Consumer Protection Act). You are not required to use the program if you choose to seek redress by pursuing rights and remedies not created by those laws.

Members of the Armed Forces who purchased the vehicle in California, or who were stationed in or a resident of California at the time of purchase (regardless of state of purchase) or who are stationed in California at the time of application to this program, may utilize the CAP-RV program.

OUTLOOK

SECTION 2 – SAFETY AND PRECAUTIONS

GENERAL WARNINGS

- Only seats equipped with seat belts are to be occupied while the vehicle is moving.
- Make sure all passengers have seat belts fastened. Lap belts should fit low on the hips and upper thighs. The shoulder belt should be positioned snug over the shoulder.
- For pregnant women, the lap belt should be placed under the abdomen and across the upper thighs. The shoulder belt should be positioned across the center of the chest. Consult your doctor if you have any questions.
- Child restraints should be installed properly according to manufacturer's instructions. See "Child Restraints".
- All moveable or swiveling seats should be placed and locked in position while the vehicle is moving.
- Never let passengers stand or kneel on seats while the vehicle is moving.
- Sleeping facilities are not to be utilized while vehicle is moving.
- Examine the escape window and be familiar with its operation.
- Inspect the fire extinguisher monthly for proper charge and operating condition. This should also be done before beginning a vacation or any extended trip.

DRIVING SAFETY

- Do not attempt to adjust the driver's seat while the vehicle is moving.
- Do not adjust tilt steering in a moving vehicle.
- Do not operate the cruise control on icy or extremely wet roads, winding roads, in heavy traffic, or in any other traffic situation where a constant speed cannot be maintained.

- Use care when accelerating or decelerating on a slippery surface. Abrupt speed changes can cause skidding and loss of control.
- Never drive the vehicle with a slideout room extended.
- Driving through water deep enough to wet the brakes may affect stopping distance or cause the vehicle to pull to one side. Check brake operation in a safe area to be sure they have not been affected. Never operate any vehicle if a difference in braking efficiency is noticeable.
- Adverse weather conditions and extremes in terrain may affect handling and/or performance of your vehicle. Refer to your chassis manual for related information.

FUEL AND PROPANE GAS

 **DANGER**

All pilot lights, appliances, and their ignitors (see operating instructions) shall be turned off before refueling of motor fuel tanks and/or propane containers. Failure to comply could result in death or serious injury.

 **WARNING**

Propane gas containers, gasoline, or other flammable liquids shall not be placed or stored onboard the vehicle because a fire or explosion may result. Propane gas containers are equipped with safety valves, which relieve excessive pressure by discharging gas to the atmosphere. Failure to comply could result in death or serious injury.

SECTION 2 – SAFETY AND PRECAUTIONS

OUTLOOK

- All pilot lights must be extinguished and appliances turned off while refilling the fuel tank or LP gas tank.
- Never smoke while refilling vehicle fuel tank or LP gas tank.
- Never use an open flame to test for LP gas leaks. Replace all protective covers and caps on LP system after filling. Make sure valve is closed and the door is latched securely.
- Never connect natural gas to the LP gas system.
- When lighting range burners, **do not** turn burner controls to “On” and allow gas to escape before lighting match.
- Portable fuel-burning equipment, including wood and charcoal grills and stoves shall not be used inside the recreational vehicle. The use of this equipment inside the recreational vehicle may cause fires or asphyxiation.
- LP gas regulators must always be installed with the diaphragm vent facing downward. Regulators are equipped with a protective cover. Make sure that the regulator vent faces downward and that the cover is kept in place to minimize vent blockage, which could result in excessive gas pressure causing fire or explosion.
- The following warning label is located in the cooking area to remind you to provide an adequate supply of fresh air for combustion.



Unlike homes, the amount of oxygen supply is limited due to the size of the recreational vehicle, and proper ventilation when using the cooking appliance(s) avoids dangers of asphyxiation. It is especially important that cooking appliances not be used for comfort heating, as the danger of

asphyxiation is greater when the appliance is used for long periods of time. Failure to comply could result in death or serious injury.

LP GAS LEAKS

The following procedures are located in the vehicle near the range area. If you smell gas within the vehicle, quickly and carefully perform the procedures listed.

IF YOU SMELL PROPANE

- Extinguish any open flames, pilot lights, and all smoking materials.
- Do not touch electrical switches.
- Shut off the gas supply at the tank valve(s) or gas supply connection.
- Open doors and other ventilating openings.
- Leave the area until odor clears.
- Have the propane system checked and leakage source corrected before using again.

Failure to comply could result in death or serious injury.

PROPANE GAS LEAK DETECTOR

Your coach is equipped a propane gas leak detector, similar to the one shown below. The leak detector sounds an alarm if an unsafe amount of propane gas is present inside the coach.

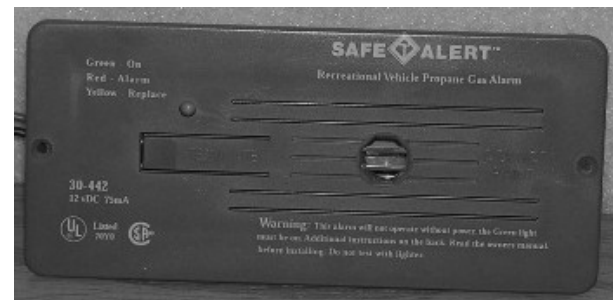

Propane Gas Leak Detector

Because propane gas is heavier than air, the leak detector is located on a cabinet face near the floor of the coach.

WARNING

EXPLOSION HAZARD: DO NOT use an open flame to test for gas leaks. When testing for gas line leaks with a soapy water solution, DO NOT use a detergent containing ammonia or chlorine. These substances may generate a chemical reaction causing corrosion to gas lines, resulting in dangerous leak conditions. Death or serious injury can result.

Power Connection

The propane gas leak detector is powered by the house batteries. If the house/coach battery switch is shut off or the battery cable is disconnected from the batteries, the alarm will not work. The propane gas leak detector fuse or circuit breaker is located in the 12-volt house electrical load center.

Because the propane gas leak detector is connected to the house battery, it is always drawing a small amount of current. Even though this current draw is slight, it could drain the house battery during storage periods when the house battery will not be charged regularly by the engine or shoreline.

Further Information

See the manufacturer’s information in your InfoCase for further instructions on nuisance alarms and care and testing of the propane gas leak detector.

The best protection against carbon monoxide entry into the vehicle body is a properly maintained engine exhaust and ventilation system. It is recommended that the exhaust system and body be inspected by a qualified motor home service center:

- Each time the vehicle is serviced for an oil change.
- Whenever a change in the sound of the exhaust system is noticed.
- Whenever the exhaust system, underbody, or rear of the vehicle is damaged.

To allow proper operation of the vehicle’s ventilation system, keep front ventilation inlet grill clear of snow, leaves, or other obstructions at all times. **DO NOT OCCUPY A PARKED VEHICLE WITH ENGINE RUNNING FOR AN EXTENDED PERIOD.**

Do not run engine in confined areas, such as a garage, except to move vehicle into or out of the area.

CARBON MONOXIDE ALARM

Your coach is equipped with a carbon monoxide (CO) alarm located on the ceiling in the bedroom area. The CO alarm is powered by a 9-volt battery and has a sensor that is designed to detect toxic carbon monoxide gas fumes resulting from incomplete combustion of fuel. It will detect CO gas from any combustion source such as the furnace, gas range/oven, water heater, refrigerator, chassis engine, and electric generator engine.

CARBON MONOXIDE WARNING

WARNING

Avoid inhaling exhaust gases, as they contain carbon monoxide, which is a colorless, odorless, and poisonous gas. Death or serious injury can result.



Carbon Monoxide Alarm

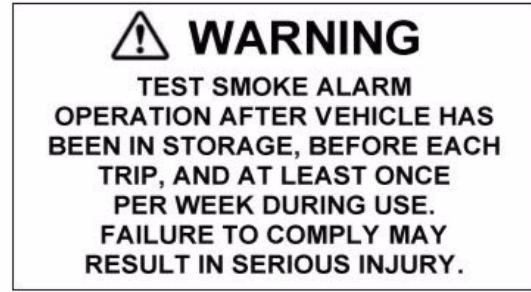
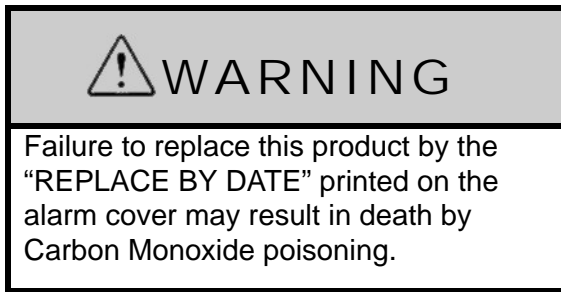

Replacement

When replacing this alarm, we recommend replacing only with the same model, or with one that is also listed for RV application. We recommend obtaining a replacement from your Winnebago Industries® dealer.

Further Information

Please read the information provided by the manufacturer, which is included in your InfoCase for further information.

Further Information

See the manufacturer’s information in your InfoCase for further instructions.

Replacement

When replacing this alarm, we recommend replacing only with the same model, or with one that is also listed for RV application. We recommend obtaining a replacement from your Winnebago Industries® dealer.

SMOKE ALARM

Your motor home is equipped with a smoke alarm located on the ceiling in the lounge area. The smoke alarm is powered by a 9-volt battery and has a sensor that is designed to detect smoke.



Smoke Alarm

The following label is affixed to the smoke alarm.

FIRE EXTINGUISHER

A dry chemical fire extinguisher is located near the main entrance door.



Fire Extinguisher
(Typical installation - your coach may vary according to model and floorplan)

We recommend that you become thoroughly familiar with the operating instructions displayed on the side of the fire extinguisher and in the information supplied in your InfoCase.

We also recommend that you inspect the fire extinguisher for proper charge at least once a month in accordance with National Fire Protection Association (NFPA) recommendations as stated on the label.

If the charge is insufficient, the fire extinguisher must be replaced.

NOTICE

Do not test the fire extinguisher by discharging it. Partial discharge can cause leakage of pressure or contents, which would render the unit inoperative when needed. When using the fire extinguisher, aim the spray at the base of the fire.

Replacement

If for any reason you must replace the fire extinguisher, the replacement must be the same type and size as the one originally supplied in your coach. We recommend obtaining a replacement only from your Winnebago Industries® dealer or a reliable RV parts supplier.

ELECTRICAL

- Careless handling of electrical components can be fatal. Never touch or use electrical components or appliances while feet are bare, while hands are wet, or while standing in water or on wet ground.
- Improper grounding of the vehicle can cause personal injury. Do not plug the utility power cord into an outlet which is not grounded and do not adapt the plug to connect to a receptacle for which it is not designed.
- Do not attach an extension cord to the utility power cord.
- Do not use any electrical device that has had the ground pin removed.
- Avoid overloading electrical circuits. Replace fuses or circuit breakers with those of the same size and amperage rating only. Never use a higher rated fuse or breaker.
- Use caution when handling or working near electrical storage batteries. Always remove jewelry and wear protective clothing and eye covering. Avoid creating sparks.

LOADING

- Store or secure all loose items inside the motor home before traveling. Possible overlooked items such as canned goods or small appliances on the countertop, cooking pans on the range, or free-standing furniture items can become dangerous projectiles during a sudden stop.
- Be aware of GVWR, GAWR, and individual load limit on each tire or set of duals (See “Loading the Vehicle” in Section 12).
- Never load the motor home in excess of the gross vehicle weight rating of the gross axle weight rating for either axle.

MAINTENANCE

- Do not remove the radiator cap while engine and radiator are still hot. Always check coolant level visually at the see-through coolant reservoir.
- Never get beneath a vehicle that is held up by a jack only.
- Do not mix different construction types of tires on the vehicle, such as radial, bias, or belted tires, as vehicle handling may be affected. Replace tires with exact size, type, and load range.

EMERGENCY EXITS

Escape Window

The escape window is secured by two red safety latches at the bottom of the window.

To open, lift both latches up and toward the center of the window, then push outward near the bottom of the window.



Escape Window - Lift latch handles upward to open.

Using Slider Windows As Emergency Exits

Some coaches are required to have a slider window as an alternate exit. This window will be marked EXIT and have a red-handled latch.

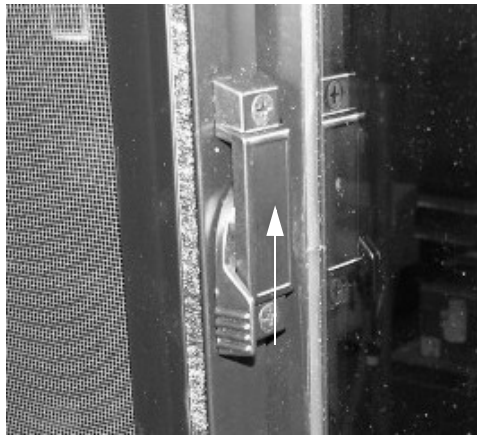

Pull latch UP to slide window open

Most slider windows along the side of any motor home can also be used as alternate emergency exits, should the need arise.

To use a slider windows as an exit, first slide the window open, then either slide the screen open or push the screen material out, depending on window construction.

Rear Escape Window

Some models may have a push-out rear escape window on the backwall of the coach.

To open, pull on the red plastic strap at the bottom of the window to remove the rubber cord that holds the window in place. Pull on the rubber cord until it is completely removed. This allows the window to be pushed out.



- Pull red strap to remove black rubber window retainer cord.
- Pull cord out completely and push window out of rubber frame.

Use rear escape window for emergency exit only. Do not test for proper operation. If the cord is released by accident, but the glass remains in place, the cord can be replaced using a blunt instrument, preferably one made of plastic. We recommend you contact your dealer for assistance.

SLIDEOUT ROOMS

! WARNING

Your motor home may have more than one slideout room. Understand which switch operates which slideout room prior to operation. Make sure all slideout rooms are clear of people who could be harmed or obstacles that could cause damage prior to operating any slideout rooms. Failure to observe can result in death or serious injury.

Check inside and outside the vehicle to make sure that there are no people who could be harmed or obstacles that could cause damage due to room activation.

WARNING

Keep all persons clear of the slideout room and moving parts while extending or retracting. Do not occupy the slideout room while it is being extended or retracted. Failure to observe can result in death or serious injury.

FORMALDEHYDE INFORMATION

Some of the materials used in this recreational vehicle emit formaldehyde. Eye, nose, and throat irritation, headache, nausea, and a variety of asthma-like symptoms, including shortness of breath have been reported as a result of formaldehyde exposure. Reaction to formaldehyde exposure may vary among individuals. Elderly persons and young children, as well as anyone with a history of asthma, allergies, or lung problems may be at greater risk. Research is continuing on the possible long-term effects of exposure to formaldehyde. Inadequate ventilation may allow formaldehyde and other contaminants to accumulate in indoor air. Ventilation to dilute the indoor air may be obtained from a passive or mechanical ventilation system. Always be sure to thoroughly ventilate your recreational vehicle before and during each use. High indoor temperatures and humidity may raise formaldehyde levels. When a recreational vehicle is in areas subject to high temperatures, an air conditioning system can be used to control indoor temperature levels. If you have any questions regarding the health effects of formaldehyde, consult your doctor or local health department.

MOLD, MOISTURE, AND YOUR MOTOR HOME

What is Mold?

Molds are part of the natural environment. They are as old as the Earth itself and mold spores are almost everywhere at some level waiting to grow. Mold plays a part of nature by breaking down dead organic matter, such as fallen leaves and dead trees. Indoors however, mold growth should be avoided. Molds reproduce by means of tiny spores. Those spores are invisible to the naked eye and float throughout the outdoor and indoor air. Because of the nature of the use of a motor home, it is natural for a motor home to be introduced into an environment with mold spores.

Mold is a plant and requires its own special environment to grow. That environment includes organic materials, nutrients, moisture, and proper temperature.

How Can I Avoid Mold?

To reduce the ability for mold to grow, you must reduce what constitutes its growth environment. Mold can grow with the smallest of a nutrient base. Just small amounts of dirt or dust on the carpet can be enough to allow the mold process to begin. Keep the environment as clean as possible. Vacuum the carpet. Clean food spills thoroughly and quickly. Avoid grease buildup near the stove or sink. Clean the exhaust fan above the stove often.

Minimize moisture in your motor home and keep humidity low. Clean spills quickly. Do not allow condensation to build up. You can open windows and vents to minimize condensation. Use of the air conditioner can assist in removing moisture from the air. Avoid leaks, but if leaks do occur, make repairs promptly.

Avoid bringing mold into your motor home. Plants, cloths, books, and other household items may already have mold present. It is easy to transfer mold into your motor home environment.

Monitor your motor home. Periodically check those hidden areas in corners, closets, and cabinets to assure mold is not present.

What if I Find Mold?

If mold develops, clean the area with a concentrate of soap and bleach. Items that contain mold that cannot be cleaned should be removed from the vehicle.

Can Mold Harm Me?

The effects of mold and airborne mold spores may cause irritation to some people. Experts disagree on the level of exposure that may cause health concerns.

If Mold Is Present, What Will Winnebago Industries® Do?

If Winnebago Industries determines that mold is present in the Winnebago®/Itasca® motor home as a result of a manufacturing defect reported to Winnebago Industries within the limited warranty period, Winnebago will clean the affected area(s) and/or replace affected items as it deems necessary. This is the extent of coverage provided by Winnebago Industries. Winnebago Industries, however, will not assume responsibility for mold deemed to be a result of a motor home users lack of timely and appropriate action to mitigate circumstances should a problem occur.

If Winnebago Industries determines that mold is present due to conditions it determines is not a result of a manufacturing defect found within the warranty period, Winnebago Industries will not provide any financial assistance to the repair of the condition.

The ladder on your motor home is provided for limited access to the roof.

Walking or working on the roof should be left to qualified service personnel using proper safety equipment in a safe environment. You should only walk or work on the roof if you are qualified and have created a safe environment.

For your safety, it is not recommended that you store or carry items on the roof.

Before Using the Ladder

- **Inspect the ladder** to make sure it is not damaged. Never use a damaged ladder.
- **Keep the rungs of the ladder clean and dry** while in use. Never use the ladder when it is raining, snowing, or icy. The rungs can become slippery. Do not step onto the rungs if the rungs are wet, or if your shoes are wet or carry mud or debris that could result in a loss of footing.
- **Never ignore warning labels** or weight limits defined on your ladder. The following warning label is located on or near the ladder:

 WARNING
Do not exceed 225-lb. maximum weight capacity. Misuse of ladder could result in death or serious injury. See Operators Manual before using ladder.

- **Maximum Capacity: 225 lbs.**
- **Do not overload.** Ladder is intended for one person.
- **Make sure you are physically capable** to safely use the ladder. Strength, flexibility, and stability are required.
- **Be aware that the vehicle may sway** as you climb the ladder. Do not use the ladder in high winds.
- **As you climb the ladder,** grasp the side rails firmly and always use both hands. Keep your body centered between the side rails. Do not over-reach.
- **Never allow children** on the ladder.
- **Do not transport items** anchored to the ladder. You could damage the ladder.

ROOF AND LADDERS

 WARNING
Stay off roof. Roof surface may be slippery. Falling could result in death or serious injury.

ROADSIDE EMERGENCY

Because of the size and weight of this vehicle and its tires, and the possible complications involved in tire changing, we strongly advise obtaining professional road service to change a flat tire whenever possible. However, if an emergency requires you to change the tire yourself, please exercise extreme caution and read all tire changing information in the chassis manual.

Never get beneath a vehicle that is held up by a jack only.

If You Get A Flat Tire

- DO NOT panic.
- Grip the steering wheel firmly and steer the vehicle as straight as possible. Avoid quick maneuvers. You may need to counter-steer to compensate for “pull” created by the failed tire.
- DO NOT stomp on the brake. This abruptly shifts the vehicle’s weight forward, making it nose-dive and pull toward the blown-out side.
- DO NOT jerk your foot off the accelerator. Just ease back on the accelerator slowly and gently to continue momentum. The deflated tire will slow the vehicle.
- If you must change lanes to get to a safe stopping place, use your signals to warn other motorists and change lanes smoothly and carefully after you are certain the lane is clear.
- Let the vehicle coast to a stop, gently steering to a safe stopping place off the traffic lanes of the road. Do not worry about damaging the tire or wheel rim by driving on it. A tire or wheel replacement is cheaper than damaging the vehicle or injuring yourself.
- When you have come to a stop, activate your hazard flashers to warn other motorists, then exit the vehicle carefully.
- Set out flares or other warning devices.

Check your tires for proper inflation before each trip and at least once a month with an accurate tire gauge.

Spare Tire Storage

If your coach is supplied with a spare tire, it may be located inside a rear storage compartment.

Some models, however, may have a swing-down spare tire carrier beneath the rear of the coach. Please follow all safety warnings and instructions for removing spare tire from the carrier.

Swing-Down Carrier (if equipped)

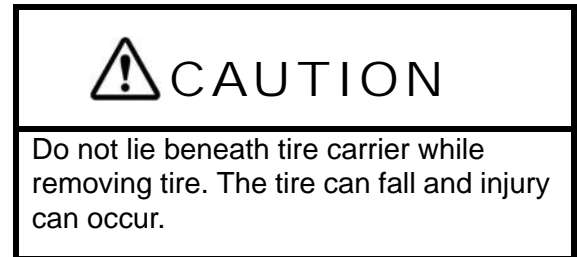

- Support tire carrier with a jack or block while removing wire pin and wing nut from bolt at front of carrier.
- Carefully lower tire carrier to ground.
- Remove 2 bolts and retainer plate that hold wheel to carrier bracket.
- Lift or slide tire from carrier.
- Do not over-tighten wing nut when returning carrier to storage position.

Recovery Towing

When calling a professional towing service, we recommend that you advise them of your coach length and approximate front axle weight listed on your Vehicle Certification Label. This will allow the towing operator to determine the proper towing equipment to use.

We recommend that you ask for an underlift (wheel lift or frame lift) type towing assembly for safe towing.

Winnebago Industries® does not assume responsibility for damage incurred while towing this vehicle.

NOTE: Consult the chassis manual for any additional towing instructions or precautions provided by the chassis manufacturer.

NOTICE

Do not lift on bumper. Damage will result to front end body parts.



WARNING

Stay out from beneath the motor home while it is suspended by the towing assembly. Do not allow passengers to occupy a towed vehicle. Death or serious injury can result.

NOTICE

Operating a vehicle under a severe overheating condition can result in damage to the vehicle.

For information on what to do in case of overheating, consult your chassis manual.

JUMP STARTING

If your coach will not start from the chassis battery, try using the battery boost switch to divert power from the house batteries to the starter. (See either “Battery Boost Switch” or “Aux Start Switch”).

If you wish to try jump starting the engine using another vehicle or booster system, see your chassis manual for connecting jumper cables to the automotive electrical system.

NOTICE

Do not attempt to push start this vehicle. Damage to the transmission or other parts of the vehicle will occur.

ENGINE OVERHEAT

If you see or hear steam escaping from the engine compartment or have any other reason to suspect an extreme engine overheating condition, pull the vehicle over to the roadside as soon as it is safe to do so, stop the engine, and get all passengers out of the vehicle.

OUTLOOK

SECTION 3 – DRIVING YOUR MOTOR HOME

The information in this section refers only to features installed or adapted to the dash and driver compartment area by Winnebago Industries®. It also includes passenger seating in the living area of the coach.

Further Information

See the chassis manual in your InfoCase for all original chassis related controls, instrumentation, switches, and other features. This includes items such as cruise control, climate controls, gauges, wipers, lights, front seats, and three-point safety belts, etc.



Folding Dinette Seat Back

- Remove dinette seat backrest cushion
- Unfasten bolt latch at aisle side of seat

SEATS – DRIVER/CO-PILOT

The driver and co-pilot seats may be independently adjusted to suit individual preference.

Further Information

See the chassis manual in your InfoCase for instructions on seat adjustments.



- Fold dinette seat backrest down to recline front seat

FOLD-DOWN DINETTE SEAT

(Models without front slideout and with dinette seat directly behind driver or passenger front seat)

On some models, the dinette seat located directly behind the driver or passenger front seat must be folded down to allow front seat reclining.

Typical view - your coach may vary according to model and floorplan.

SEAT BELTS

Seats intended for occupancy while the vehicle is in motion are equipped with seat belts for the protection of the driver and passengers.

Lap Belts

The lap belts must be worn as low as possible and fit snugly across the hip area. Always sit erect and well back into the seat. To gain full protection of the safety belt, never let more than

one person use the same safety belt at any one time, and do not let the safety belts become damaged by pinching them in the doors or in the seat mechanism. After any serious accident, any seat belts which were in use at the time must be inspected and replaced if necessary.

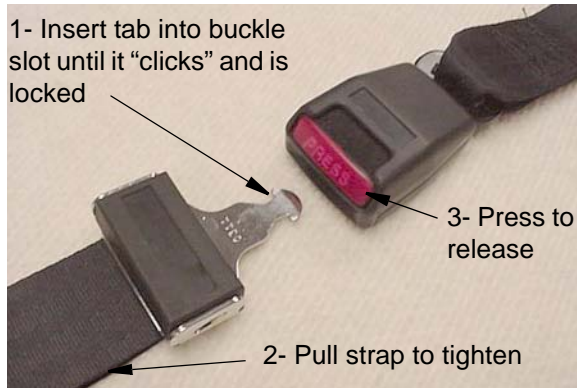

Adjustment:

To lengthen belt, swivel the tab end at a right angle to belt and pull strap to desired length. To shorten, pull loose end of belt.

To Fasten:

Be sure belt is not twisted. Grasp each part of the belt assembly and push tongue into buckle. Adjust to a snug fit by pulling the loose end away from the tongue.

To Release:

Press button in center of buckle and slide tongue out of buckle.

 WARNING
Snug and low belt positions are essential. This will ensure that the force exerted by the lap belt in a collision is spread over the strong hip area and not across the abdomen, which could result in serious injury. Only seats equipped with seat belts are to be occupied while vehicle is in motion.

Lap/Shoulder Belts

See your chassis manual for instructions on proper fastening, adjustment, and releasing of lap/shoulder belts.

Seat Belt Care and Cleaning

- Be careful not to damage the belt webbing and hardware. Take care not to pinch them in the seat or doors.
- Inspect the belts and hardware periodically. Check for cuts, frays, and loose parts. Damaged parts should be replaced. Do not remove or modify the belt system.
- Keep belts clean and dry. If the belts need cleaning, use only a mild soap and water solution. Do not use hot water. Do not use abrasive cleaners, bleach, or dyes. These products may weaken the belts.
- Replace any belt assembly that was used during a severe impact. Replace the complete assembly even if damage is not apparent.

CHILD RESTRAINTS

-If Equipped

A properly installed and secured child restraint system can help reduce the chance or severity of personal injury to a child in an accident or during a sudden maneuver. Children may have a greater chance of being injured in an accident if they are seated in a child restraint system which is not properly secured.

A child restraint system is designed to be secured in a vehicle seat by a lap belt or the lap belt portion of a lap-shoulder belt.

When purchasing a child restraint system, follow these guidelines:

1. Look for the label certifying that it meets all applicable safety standards.
2. Make sure that it will attach to your vehicle and restrain your child securely and conveniently so that you are able to install it correctly each time it is used.

3. Be certain that it is appropriate for the child's height, weight, and development. The instructions and/or the regulation label attached to the restraint typically provides this information.
4. Review the instructions for installation and use of the restraint. Be sure that you understand them fully and can install the restraint properly and safely in your vehicle.

Tether Anchor Loop

-If Equipped

If your coach has a dinette, it may be equipped with a child seat tether anchor loop located on the floor directly behind the forward facing dinette seat.



The dinette table must be in the lowered position when a child seat is in use.



1. Lower the dinette table.
2. Route the tether over the top of the dinette seat back and hook it to the anchor loop on the floor.
3. Fasten the lap belt.

See the child seat manufacturer's specific instructions for proper attachment and adjustment of the tether and seat belts.

KEYS

Your motor home is supplied with several keys. In addition to the chassis manufacturer's ignition key, you receive keys for the entrance door and exterior compartment doors.

Keys have an identification number, either a small metal tag or stamped into the key head. These numbers are recorded on the vehicle's component model/serial sheet, which is included in your InfoCase. In case keys are lost or stolen, your dealer or a locksmith can provide you with duplicate keys or modify the locks.

KEYONE™ LOCK SYSTEM

-If Equipped

Your coach is equipped with the KeyOne lock system. A single key will open every door lock in the entire motor home (except the security deadbolt lock on the entrance door).

The key number for your coach is registered in our factory database, so if you ever lose your keys, any Winnebago Industries® dealership can order a new key for you.

HAZARD WARNING FLASHERS

The hazard warning flashers provide additional safety when the vehicle must be stopped on the side of the roadway and presents a possible hazard to other motorists. When the flashers are on, it serves as a warning to other drivers.

Further Information

See your chassis manual for instructions on activating, operating, and canceling hazard warning flashers.

**MIRRORS – POWER SIDEVIEW
EXTERIOR**

–If Equipped

Always adjust mirrors for maximum rear visibility before driving off. Make sure the seat is adjusted for proper vehicle control and that you are sitting back squarely into the seat.

The mirrors may also contain heating elements to de-fog or de-ice the mirror glass during cold weather operation. An ON-OFF switch for the mirror heaters is located near the remote mirror controls.

The ignition switch must be on to operate mirror controls and heaters.



Mirror Adjustment Control

Mirror Heat Switch

- Mirror surface tilts in direction of arrow button pressed.
- Middle switch selects L or R mirror to adjust.
- Center position is “neutral” to disable arrow buttons and prevent misadjustment of mirrors.



The mirrors can be folded back against the cab doors if needed.

Mirror Head Adjustment

If you cannot adjust a mirror properly using the control switch, the mirror may need a coarse adjustment by rotating the mirror head.

BATTERY BOOST SWITCH

This switch can be used to draw emergency starting power from the house batteries to start the engine if the chassis battery is discharged.

Press and hold in the ON position while turning ignition key for emergency starting power.

NOTE: The House/Coach Battery Disconnect switch near the entrance door must be ON and house batteries must be sufficiently charged for this feature to work.



Battery Boost Switch

(Typical View - depending on model)

If chassis battery is discharged, press and hold while turning ignition key for emergency starting power.

AIR CONDITIONER/HEATER – AUTOMOTIVE (DASH)

See your chassis manual for operating information on driver and passenger comfort controls – air conditioner, heater, defroster, and ventilation.

NOTE: The dash air conditioner is not designed to cool the entire interior of the coach, but is intended only to provide cooling for the cab area.

RADIO IN-DASH/REARVIEW MONITOR SYSTEM

–If Equipped

The rearview camera monitor system lets you see what is directly behind your coach for safety and maneuvering assistance. The viewing screen is integrated into the dash.

The monitor screen “wakes up” automatically when transmission is shifted into reverse. A microphone built into the rear camera lets you hear warning sounds or verbal directions from an assistant.



Basic Operating Instructions

- **POWER ON/OFF** - Push to turn ON or OFF. Push and hold to turn screen OFF. Touch screen to turn back ON.
- **MENU** - Press to access USER SETTING MENU. Press and hold access SYSTEM SETUP MENU.



- **AUDIO** - Press and hold access AUDIO MENU. Press to return to current playback mode.
- **CAM** - Press to access CAMERA mode. Press and hold access CAMERA SETTINGS MENU.
- **MUTE** - Press to MUTE audio.
- **EJECT** - Press to EJECT CD.
- **DAY/NIGHT** - Press to switch between stored DAY/NIGHT user settings. Press and hold to access AUTO DAY/NIGHT adjust.
- **AUX IN** - Connect portable audio player.
- **USB** - Connect a USB Jump Drive. NOT FOR IPOD CONTROLS.



Satellite Radio

–If Equipped

Your coach may be equipped with a Sirius® satellite radio receiver that plays through your radio.

See the receiver manufacturer’s information in your InfoCase for programming and operating instructions.

NOTE: If your Sirius tuner is not activated, follow the instructions in the radio owners manual in your InfoCase for the phone number to call and procedure to access the Sirius Tuner ID Number (ESN).

iPod Cable

-If Equipped

Your coach is equipped with a cable to connect your iPod to play through your radio. This cable is in the motorcover beverage tray. See following photo.



-Typical View

See the manufacturer's information in your InfoCase for operating instructions.

Radio Remote Controls

-If Equipped

A hand-held remote allows the passenger to change radio stations or CD selections from the convenience of their seat. The hand-held radio remote is in your InfoCase. See the manufacturer's user guide included your InfoCase for remote control instructions.

Radio Power Switch

The radio power switch on the dash lets you connect the dash radio to the coach batteries when the ignition switch turned off for listening while parked. This prevents accidental draining of the chassis battery by prolonged use of the radio.

NOTE: The Coach/House Battery Disconnect Switch must be on while listening to the dash radio because the audio relay is powered by house batteries. If the Coach/House Battery Disconnect Switch is off, the speakers will not emit sound.



Radio Power Switch
(Located in dash area)
-Typical View

Radio Sound through Deluxe Sound Speakers

-If Equipped

To Listen to the Dash Radio through the Deluxe Sound Speakers:

- Press the Speaker Selector Switch to RADIO position to connect the dash radio to the deluxe sound speakers. Speaker switch is located near the DVD player.
- Adjust volume with radio buttons or radio remote.



Further Information

See the rearview monitor reference guide provided in your InfoCase for specific instructions provided by manufacturer.

RADIO – IN-DASH

-If Equipped

The radio in your coach can receive AM/FM stereo and weather band stations. It also has a compact disc (CD) player for your listening enjoyment through quality high-output speakers located in several areas of the coach.



Please refer to the manufacturer's operating guide in your InfoCase for detailed instructions on programming preset station buttons and using this full-featured radio/audio system.

Satellite Radio

-If Equipped

Your coach may be equipped with a Sirius® satellite radio receiver that plays through your radio.

See the receiver manufacturer's information in your InfoCase for programming and operating instructions.

NOTE: If your Sirius tuner is not activated, follow the instructions in the radio owners manual in your InfoCase for the phone number to call and procedure to access the Sirius Tuner ID Number (ESN).

iPod Cable

-If Equipped

Your coach is equipped with a cable to connect your iPod to play through your radio. This cable is in the motorcover beverage tray. See following photo.



-Typical View

See the manufacturer's information in your InfoCase for operating instructions.

Radio Remote Controls

A steering wheel mounted remote control for the radio lets you change radio stations or CD selections without taking your eyes off the road or hands off the wheel.



Radio Remote Control
-Typical View

An additional hand-held remote allows these same conveniences for the passenger. The hand-held radio remote is in your InfoCase.

Radio Power Switch

The radio power switch lets you connect the dash radio to the coach batteries with the ignition switch turned off for listening while parked. This prevents accidental draining of the chassis battery with prolonged use of the radio.

SECTION 3 – DRIVING YOUR MOTOR HOME

OUTLOOK

NOTE: The Coach/House Battery Disconnect Switch must be on while listening to the dash radio because the audio relay is powered by house batteries. If the Coach/House Battery Disconnect Switch is off, the speakers will not emit sound.

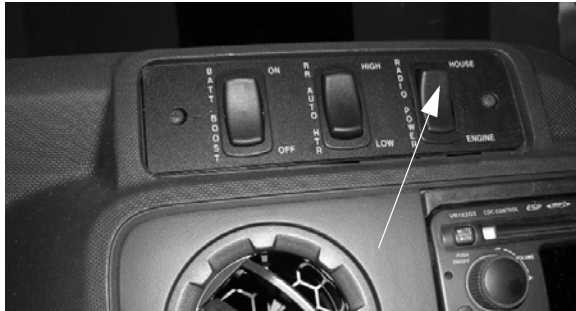

Radio Power Switch
(Located in dash area)
-Typical View

Radio Sound through Deluxe Sound Speakers -If Equipped

To Listen to the Dash Radio through the Deluxe Sound Speakers:

- Press the Speaker Selector Switch to RADIO position to connect the dash radio to the deluxe sound speakers. Speaker switch is located near the DVD player.
- Adjust volume with radio buttons or radio remote.



Further Information

See the rearview monitor reference guide provided in your InfoCase for specific instructions provided by manufacturer.

SIRIUS® PLUG AND PLAY SATELLITE RADIO

-If Equipped

(Located in the bunk area or inside the entertainment center)

Take Sirius Plug and Play on the go - in your RV, at home, the office, other vehicles, or anywhere else! It is featured with universal

docking capability so you can easily move Sirius to different locations and enjoy your favorite programming (separate docking station included).



To install the satellite unit, place your Sirius radio into the docking station, aligning the tabs at the edges of the the radio adapter with the grooves in your radio. Gently push the radio down until it is fully seated in the docking station.



For complete operating instructions, see the owners manual of your headunit.

When your Sirius radio is connected via the SiriusConnect Docking Kit to your headunit, the buttons and controls of the Sirius radio will be disabled, and a SiriusConnect message or logo will be displayed.

To remove the satellite unit from the docking station, press the release button while pulling the radio out of the docking station. You can now take your Sirius Plug and Play and install it in your car with the supplied car kit.



Further Information

See the Sirius user guide provided in your InfoCase for complete operating and installation instructions.

ENGINE ACCESS – INTERIOR

Front Engine Cover

- **To remove the engine cover,** unlatch the two clips (located on the left and right sides of the engine cover) and unlatch the two clips (located on each side of the bottom of the engine cover).

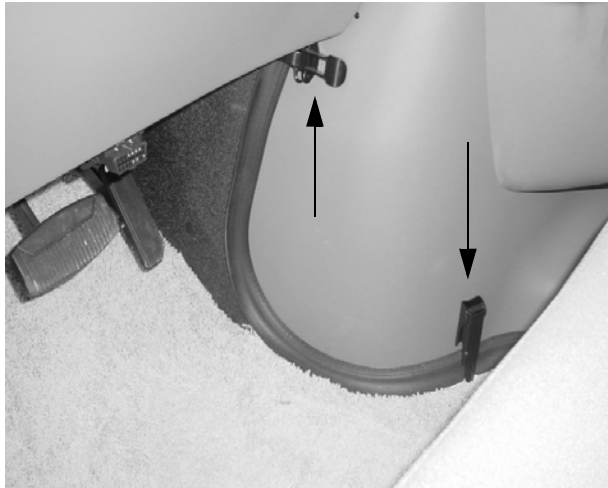

Front Engine Cover
(Typical View)

ENGINE COOLING SYSTEM

Do not remove the radiator cap while engine and radiator are still hot. Always check coolant level visually at the see-through coolant reservoir.

NOTE: Your chassis engine cooling system is filled with special extended-life coolant that is not the same as common anti-freeze available at retail outlets. The coolant system MUST be refilled or topped up with the same type of coolant as equipped to maintain the special long-life properties.

Further Information

Refer to the chassis manual in your InfoCase for information and precautions on filling, servicing, and checking the fluid level.

TIRES

Improper tire pressure can result in tire overloading and abnormal wear and also affects handling, ride characteristics, and fuel economy.

WARNING

Make sure all replacement tires are of the same size and rating as those shown on your Vehicle Certification Label.

SUSPENSION ALIGNMENT AND TIRE BALANCE

The front suspension and steering system of this vehicle was factory aligned using highly accurate equipment prior to delivery to the dealership. However, alignment should be checked and adjusted after you have fully loaded the motor home according to your personal needs. Thereafter, the alignment should be periodically inspected to help prevent uneven tire wear.

Any excessive or abnormal tire wear may indicate worn or misaligned suspension or steering, unbalanced tire, or other tire/suspension problem.

Alignment can be affected by worn steering/suspension parts or by incidents which happen during driving, such as hitting a curb, pothole, or railroad track, etc. Improper alignment can cause tires to roll at an angle and wear unevenly. It may also cause the vehicle to “pull” to the right or left. Have your dealer inspect your vehicle’s suspension and steering components periodically for misalignment or wear.

Out-of-balance tires will not roll smoothly and can lead to vibrations and uneven tread wear, such as cupping and flat spots. Tires may need to be balanced if uneven wear is detected or if ride comfort decreases noticeably.

Further Information

See the chassis manual in your InfoCase for further information.

**AIR SPRINGS – REAR HELPER
(AIR BAGS)**

–If Equipped

The rear air helper springs (air bags) are an enhancement to the standard suspension system to provide adjustable load and ride conditions. This feature is not intended to increase the load capacity of the rear axle or vehicle.

Adjustment

Check and adjust the air bag pressure periodically to maintain optimal ride and handling characteristics according to cargo weight.

Too much air pressure in the air helper springs will result in a firmer ride, while too little air pressure will allow the air helper spring to bottom out over rough road conditions. Too little air pressure will also not provide the improvement in handling that is possible.

The air bags can be adjusted independently if necessary to equalize a load, however, we recommend maintaining the same pressure in both air bags whenever possible to ensure that the vehicle remains level.

- Min. Air Pressure 20 psi
- Max. Air Pressure 80 psi



Rear Air Spring Valves
(Located inside left rear wheel well)

LIGHTS

All exterior lights should be checked for proper operation each time the vehicle is prepared for a trip. Any bulbs which fail to light should be checked and replaced, when necessary, with a new bulb of the same size. A failure of more than one light, such as both taillights not operating, may indicate a burned out fuse. Check fuse and replace with one of the same rating when necessary. If a fuse is not the cause of the problem, the wiring system should be checked immediately by an authorized service center.

Further Information

Refer to the chassis manual in your InfoCase for further information.

MOUNTAIN DRIVING

Special techniques must be used when driving in mountainous or hilly country.

Climbing A Hill

The transmission will automatically downshift as needed to climb most hills. If the hill is long or very steep, however, you may need to manually shift to a lower gear to keep the transmission from repeatedly upshifting and

downshifting. Select the lowest adequate gear range for the duration of the incline. See your chassis manual for specific information.

Descending A Hill

When going down a long grade, you may need to manually shift to a lower gear rather than keeping your foot on the brake pedal. A lower gear will allow the engine to provide a degree of braking action. Holding your foot on the brake pedal for an extended period may cause brakes to overheat, which could cause brake failure. See your chassis manual for specific information.

SECTION 4 – APPLIANCES AND SYSTEMS

The appliances installed in your motor home are manufactured by reputable RV appliance makers and have been tested by independent laboratories to meet all applicable standards and codes set for RV appliances.

See Section 2 of this manual for any safety and precautions you need to take regarding the operation of your appliances.

REFRIGERATOR

The refrigerator in your coach can operate from either of two energy sources available to the motor home:

- 120-Volt AC electric
- Propane gas

To be able to use both types of energy, the refrigerator does not have a compressor like household refrigerators. Instead, it uses an ammonia-water solution for cooling. Basically, ammonia vapor is distilled from the solution by heat produced from either propane gas flame or electrical heat element. The ammonia vapor is then carried to the finned condenser where it liquefies. The liquid then flows to an evaporator where it creates cooling by evaporation. The ammonia circulates back into the water solution and the cooling cycle continues.

Leveling

Before operating the refrigerator when the motor home is stationary, place a small level on the bottom of the refrigerator and make certain the unit is level. If over 1/2 of the bubble is inside the circle in any direction, the coach is level enough for continuous operation of the refrigerator while parked.



Place bubble level in bottom of refrigerator

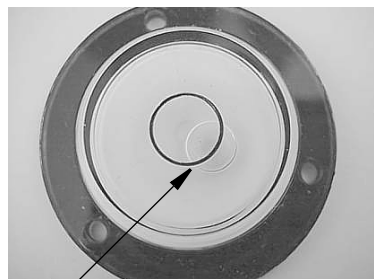

Bubble must be at least 1/2 inside circle

Normal vehicle leveling to provide comfort for the occupants is satisfactory for refrigerator operation.

NOTICE

To prevent permanent damage to the refrigerator cooling unit, turn the refrigerator off if the vehicle will be parked on an incline of over 3° side-to-side or 6° front-to-rear (such as steep driveways or parking lots, etc.) for more than one hour.

Basic Operation

Slide the control switches to the operating positions described and observe the indicator lights.



- **Gas-** Refrigerator will operate on gas from the propane tank if the main valve is open and the tank contains gas.
- **Auto-** Refrigerator will operate on 120-VAC household current if the shoreline is connected or the auxiliary generator is running. If electricity is lost, it will automatically switch over to Gas operation if gas is available.
- **Temperature Setting-** Start at the 'coldest' setting to ensure coldest temperature in the freezer compartment, then adjust warmer as necessary after cold* food has been added.
- **'On' Indicator Light-** Glows steady when refrigerator is operating properly.
- **'Gas' Indicator Light-** Will flash if gas is not available. To operate the refrigerator you must provide 120VAC then switch to Auto operation.

** The refrigerator will retain temperature more efficiently if food is cold before placing inside.*

Further Information

For further information and operating cautions, see the refrigerator operating instructions included in your InfoCase.

REFRIGERATOR SERVICE ACCESS COMPARTMENT (Exterior)

The exterior refrigerator service compartment allows access to the rear of the refrigerator for inspection, maintenance and service.

To Open:

1. Use a screwdriver or coin to turn the latch knobs to the vertical position as shown.



Refrigerator Access Door Latches

2. Remove the door from the opening.

To Close:

1. Replace the door into the opening.
2. Push the latch knobs in while turning to the horizontal position as shown.

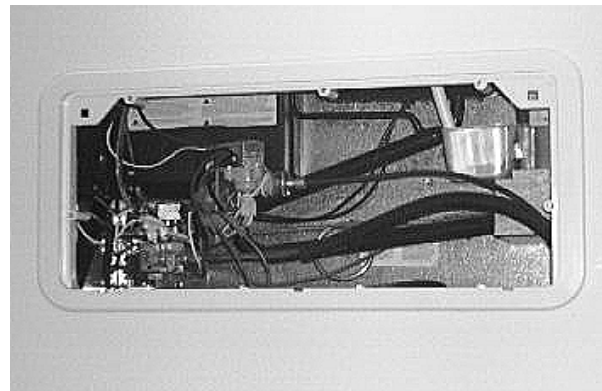

Refrigerator Access Compartment

RANGE TOP

The range in your motor home operates on propane gas and will provide most of the functions of the range in your home.



To Light Range Top Burners

- Turn the desired burner knob to HI LITE position
- Immediately spin the IGNITOR knob clockwise at least one full turn to light the burner

Avoiding Asphyxiation

The following warning label has been located in the cooking area to remind you to provide an adequate supply of fresh air for combustion.

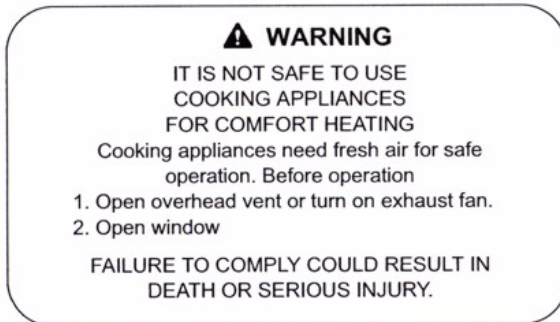

Unlike homes, the amount of oxygen supply is limited due to the size of the recreational vehicle, and proper ventilation when using the cooking appliances avoids dangers of asphyxiation.

It is especially important that cooking appliances not be used for comfort heating, as the danger of asphyxiation is greater when the appliance is used for long periods of time.

FAILURE TO COMPLY COULD RESULT IN DEATH OR SERIOUS INJURY.

WARNING

Portable fuel-burning equipment including wood and charcoal grills and stoves, shall not be used inside the recreational vehicle. The use of this equipment inside the recreational vehicle can cause fires or asphyxiation. Failure to comply could result in death or serious injury.

Further Information

See the appliance manufacturer's operation manual in your InfoCase for complete features and operating instructions.

MICROWAVE OVEN/RANGE HOOD

The range hood vent is built into the microwave oven. The range hood fan carries cooking odors and gas fumes to the outside of the coach. A light on the underside of the hood provides illumination for food preparation. The hood fan and light switches are located on the microwave control panel.



Microwave/Range Hood - Typical (brand, model, and appearance shown may vary from your model)

Further Information

See the manufacturer’s information in your InfoCase for microwave operating instructions and replacement of vent hood light bulbs and replacement or cleaning of grease filter elements.

SYSTEMS MONITOR PANEL

The Systems Monitor Panel provides a convenient central location for checking the condition of all utility systems in your coach.



At the touch of a button this panel will display the fresh water and holding tank levels, propane gas tank level, plus the house battery condition. You can start the generator or turn on the water pump and water heater. Indicator lights tell you if the water pump is on or if the water heater pilot light is out.

Water And Holding Tank Levels

Press and Hold the “Levels Test” switch to show approximate level on the monitor lights.



The approximate fluid levels are measured by electronic sensors on the sides of the tanks. There is generally more fluid in a tank than indicated on the monitor panel.

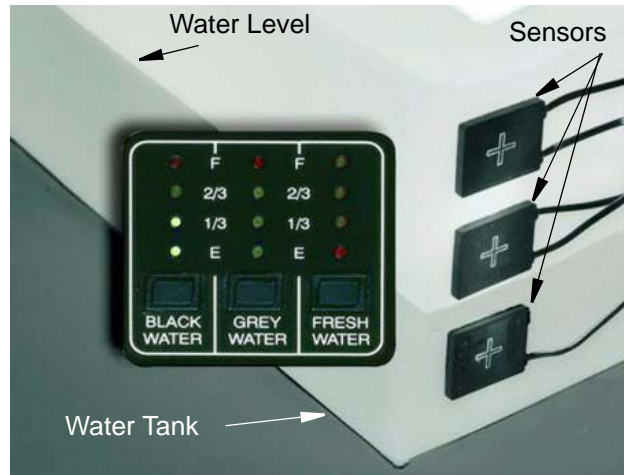

For example, if the fluid level is 1-2” below the FULL sensor, the monitor will show the level to be only 2/3 even though the tank is nearly full.

If a tank is about 1/4 full, the monitor will register an empty tank because the fluid level is below the 1/3 sensor even though there is still fluid in the tank.

However, when the indicator reads FULL, the tank is actually full.

Tank Capacities

See “Tank Capacities” in Introduction section.

Propane Gas Level

Press and Hold the “Levels Test” switch to show approximate propane tank level.

The propane level is registered by a sending unit on the tank. The gauge mounted on the side of the tank will give a more accurate indication of actual tank level if needed.

Battery Charge Meter

Press and Hold the “Levels Test” switch to check the level of charge (voltage) in the 12-volt house battery.

The colored segments (red, yellow, and green) will light from the bottom up to the amount of charge the battery contains.

- Green - good or adequate charge.

- Yellow - marginal charge.
 - Red - battery needs charging before use.
- To get an accurate reading:
1. Both the chassis engine and the generator engine must be shut off and 120-volt AC shoreline unplugged.
 2. An interior light should be turned on to provide a small load which draws off the battery surface charge.

Water Pump Switch

When use of the self-contained water system is desired, turn the “Water Pump” switch on. The “Pump On” light will illuminate when the pump switch is on and the system is operable. Water will be available as soon as a faucet is opened. Refer to “Water Pump” for additional information on the water pump and initial start-up.



(Some models may also have a pump switch in the water system compartment on the outside of the coach.)

WATER HEATER – GAS

NOTE: Read the Water Heater Operating Guide in your InfoCase for complete safety warnings, operating instructions, and maintenance information before operating the water heater.

Be sure the water heater is filled with water before starting either electric or propane operation.

To fill the water heater, turn the Water Pump switch on and open a hot water faucet anywhere in the coach. When water begins to flow steadily from the faucet, the water heater is full.

Propane Gas Operation

- Press the Water Heater switch on the Systems Monitor Panel.



- The “Pilot Out” light will glow for about 10-15 seconds, then it will go out. The “Heater On” indicator will remain lit.
- If the “Pilot Out” light comes on during propane operation, it means that the burner has gone into “lockout” mode and must be restarted. If this happens, turn the Water Heater switch off for about 5 minutes, then turn it back on.

WATER HEATER - GAS/ ELECTRIC

–If Equipped (with Motoraid water heating system)

The gas/electric water heater has a dual power feature. It can operate from propane gas or 120-volt house current; or it can use both at the same time for quicker recovery at times when you are using a lot of hot water.

Read the Water Heater Operation Manual for complete Safety Warnings, Operating Instructions and Maintenance Information before operating the water heater.

Be sure the water heater is filled with water before starting either electric or propane gas operation. To fill the water heater, turn the

Water Pump switch on and open a hot water faucet anywhere in the coach. When water begins to flow steadily from the faucet, the water heater is full.

For Propane Gas Operation

Press the Water Heater switch on the Monitor Panel. The “Pilot Out” light will glow for about 10-15 seconds, then it will go out. The “Heater On” indicator will remain lit. If the “Pilot Out” light comes on during gas operation, it means that the burner has gone into “lockout” mode and must be restarted. If this happens, turn the Water Heater switch off for about 5 minutes, then turn it back on.

See the water heater user’s guide in your InfoCase for further information.



Gas Water Heater Switch
(Located on Systems Monitor Panel)

For Electric Operation

Turn on the Water Heater electric element switch. The shoreline must be connected or generator running for electric operation.



Electric Water Heater Switch
(Located near Systems Monitor Panel)

**For Quick Recovery Operation
(Dual Heating)**

Turn On both Water Heater switches; the gas one on the monitor panel and the electric one. This will help reheat the water heater tank more quickly than a single source would alone. Use this mode when you are using a larger than normal volume of hot water.

Further Information

Read the operating and safety information provided in the Water Heater Operation Manual in your InfoCase.

MOTORAID WATER HEATER

–If Equipped

The motoraid uses heat from the chassis engine cooling system to heat water in the water heater while driving. Hoses are routed from the engine to a heat exchanger surrounding the water heater tank.

Under normal conditions, the entire contents of the water heater can be heated in about two hours or 100 miles of driving. This means you can have hot water at the faucets immediately upon arriving at a site.

The motoraid also increases the capacity of the engine cooling system.

NOTICE

Any leak in the heat exchanger or its supply or return lines could cause loss of coolant and subsequent engine failure. We recommend that you periodically inspect these connecting lines and the heater to insure that no leaks have developed.



CAUTION

Hot water can escape from tank causing injury. Operate this valve only when the water heater and engine cooling system are cold.

PRESSURE-TEMPERATURE RELIEF VALVE

On occasion, water may be seen seeping from the water heater pressure temperature relief valve. This is no cause for repair or replacement of the valve.

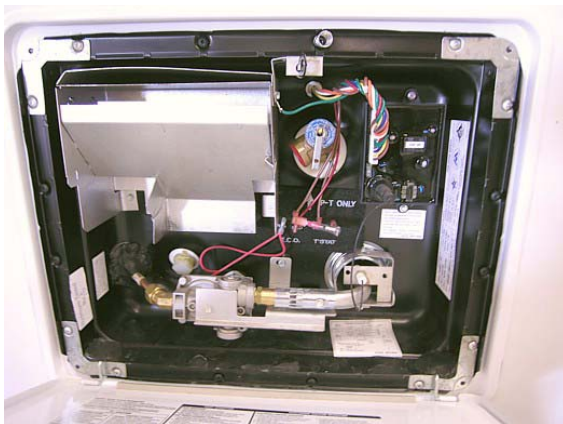

Water Heater Exterior Service Access

Normally there is an air gap at the top of the water heater tank, which acts as a pressure buffer. In time, however, heated water may expand and fill this air gap, causing a slight increase in water pressure. This may cause the P-T valve to “weep” until the air gap is manually replaced.

To Replace the Air Gap:

1. Turn off the Water Heater switch and incoming water supply (city water and/or demand pump).
2. Open a faucet in the motor home to relieve water pressure.
3. Pull the handle of the P-T valve straight out and allow water to flow until it stops.

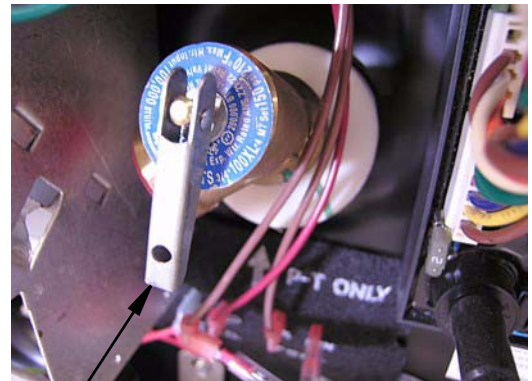

Lift handle straight out to open P-T valve when water heater is cold*

4. Let the handle of the P-T valve snap shut.
5. Close the faucet and turn on the water supply before switching the water heater on.

Manually operate the pressure temperature relief valve at least once a year.

NOTE: If your water heater is equipped with the motoraid system, it uses an extension from the engine cooling system to heat water in the water heater while driving. The engine cooling system must also be cold before opening the pressure-temperature relief valve. See “Motoraid Water Heater” for more information.

PROPANE GAS FURNACE

To Start Up:

1. Open the LP gas tank valve by turning fully counter-clockwise.



Thermostat Switch

- Move to Heat or Gas position for furnace operation

Temp Selector

- Press up or down to select temperature

2. Move THERMOSTAT switch from Off to Heat and press the Temp Selector button (Up/Down arrows) until the desired temperature is shown in the display.
3. Furnace fan should start to blow immediately after setting the thermostat.
4. After about 30 seconds, the furnace burner should light.
5. The furnace should now cycle off and on automatically as the thermostat demands just like a household furnace.

*NOTE: If heat does not come out of the heat ducts after a minute or so the burner is not lit.
Turn thermostat off for 3-5 minutes, check to be sure propane gas tank valve is open and tank is not empty, then try steps 2-4 again.
If the furnace will not light after three attempts, go to Shut Down steps and contact your dealer or a local RV service center for repair.*

To Shut Down:

1. Slide thermostat switch to Off position.

2. Close propane tank valve if coach will be stored for a period of time.

Further Information

Please see the furnace operating instructions provided in your InfoCase for further information, including operating precautions, and periodic maintenance. See the Coach Maintenance Schedule for recommended intervals.

NOTE: If the furnace burner has any residuals of metal protectant or lubricants used during manufacture of the furnace, it may smoke slightly when the furnace is used for the first time and may set off your smoke alarm.

We recommend that you provide adequate ventilation when using the furnace for the first time to avoid a nuisance smoke alarm.

We do not recommend removing the smoke alarm battery.

FURNACE-A/C THERMOSTAT OPERATION CHART

The following chart shows the system functions with the “Heat/Cool” thermostat. Disregard references to heat functions when using the “Cool Only” thermostat in the rear bedroom.

X = Switch Position O = Switch position does not matter or is inactive for this feature

FAN MODE SWITCH		THERMOSTAT SWITCH				FAN SPEED SWITCH		WHAT HAPPENS
Auto	On	Cool	Off	Gas *	Elect *	Lo	Hi	
X			X			O	O	If the Thermostat Switch is Off and the Fan Switch is on Auto, the whole heating and cooling system is off - nothing is happening.
	X		X			X		A/C Fan runs continuously at Low Speed.
	X		X				X	A/C Fan runs continuously at High Speed.
Gas Furnace Heating:								
O	O			X		O	O	Furnace Blower runs along with the LP Gas Furnace, which turns on and off as needed according to thermostat setting.
Heat Pump Heating: *								
X					X	O	O	A/C Fan runs at Low Speed along with the Heat Pump, which turns on and off as needed according to thermostat setting.
	X				X	O	O	A/C Fan runs continuously at Low Speed while the Heat Pump turns on and off as needed according to thermostat setting.
A/C Cooling:								
X		X				X		A/C Fan runs at Low Speed along with the Air Conditioner, which turns on and off as needed according to thermostat setting.
X		X					X	A/C Fan runs at High Speed along with the Air Conditioner, which turns on and off as needed according to thermostat setting.
	X	X				X		A/C Fan runs continuously at Low Speed while the Air Conditioner turns on and off according to thermostat setting.
	X	X					X	A/C Fan runs continuously at High Speed while the Air Conditioner turns on and off according to thermostat setting.

* NOTE: These instructions include the optional heat pump, which may not be equipped on your model. If you do not have a heat pump, the Thermostat Switch Gas position is the same as the Heat position on your thermostat. In this case, ignore the Electric Heat Switch settings, which apply to the heat pump only.

HEAT PUMP

–If Equipped

Your coach may be equipped with an air source heat pump built into the air conditioning system. Because the heat pump operates on electricity, it provides economical heat inside your coach and helps reduce the use of propane gas for heating in cooler weather.

A heat pump can be thought of as an air conditioner running in reverse. An air conditioner absorbs heat from the air on the inside of the coach and moves it to the outside.

The heat pump does exactly the opposite. Even cold air contains some heat, so a heat pump will extract heat from the outside air on a cold day and carry it to the inside of the coach to maintain a comfortable temperature.

The efficiency of a heat pump decreases as the outdoor air temperature drops, so supplementary heat is often needed when the outside temperature nears freezing. This system is set to automatically start the gas furnace to assist the heat pump if room temperature cools to 5 degrees or more below the thermostat set temperature. You may wish to manually switch to furnace heat to maintain a higher temperature when outside

SECTION 4 – APPLIANCES AND SYSTEMS

temperatures begin to reduce the efficiency of the heat pump. The heat pump will not operate when the outside temperature falls below 36 degrees F.

To operate the heat pump:

See the air conditioning/heat pump manufacturer's information in your InfoCase for complete operating instructions.



- Gas Heat = Gas Furnace
- **Elec Heat = Heat Pump**
- Cool = Roof Air Conditioner

Check your Air Filter

Closed or blocked vents and a dirty air filter can hinder the efficiency of a heat pump.

- Be sure ceiling vents are open to distribute heat pump output air.
- The A/C return air filter should be checked monthly for dirt build-up and cleaned or replaced as needed. See “Air Conditioner Filter” elsewhere in this section.

DUCTED ROOF AIR CONDITIONING SYSTEM

The furnace thermostat also controls ducted roof air conditioner operation when the thermostat switch is placed in “cool” position.

All cooling functions controlling to setpoint have a short cycle protection time delay of 3 minutes. There will be no delay if the cycle OFF time exceeds 3 minutes.

NOTE: The ducted roof air conditioning system has ceiling registers that can be closed if necessary to force more cool air toward

a specific area of the coach or to route cool air away from a specific area. If too many vents are closed, however, it can cause the air conditioner unit to shut down, particularly in high humidity conditions.

Further Information

Refer to the air conditioner manufacturer's information in your InfoCase for complete operating instructions.

AIR CONDITIONER FILTER

The washable foam filter should be checked monthly for dirt build-up and cleaned or replaced as needed.

It is located in the ceiling mounted return A/C grille in the lounge area.

OUTLOOK

SECTION 5 – PROPANE GAS

PROPANE GAS SUPPLY

The propane gas system supplies fuel for the gas range/oven, water heater, furnace, and refrigerator (while in gas mode). When used and handled properly, this system is safe and economical and provides modern living conveniences wherever you travel.

See *Section 2 - Safety and Precautions* in this manual for other safety and precautions you need to be aware of related to propane.

How Propane Gas Works

Propane is a type of LP (Liquefied Petroleum) gas compressed into liquid form for easy transportation and storage. Propane gas may also be called tank gas, bottle gas, or simply LP.

Propane is used by appliances in vapor form only, but is stored in the tank as a liquid under very high pressure. As the liquid gas is released, it reverts back to a vapor and expands to many times its compressed volume.

Propane Tank System

The storage reservoir for the propane gas system is a horizontally mounted tank which is permanently attached to the vehicle frame. The tank is accessible only from the outside of the vehicle.

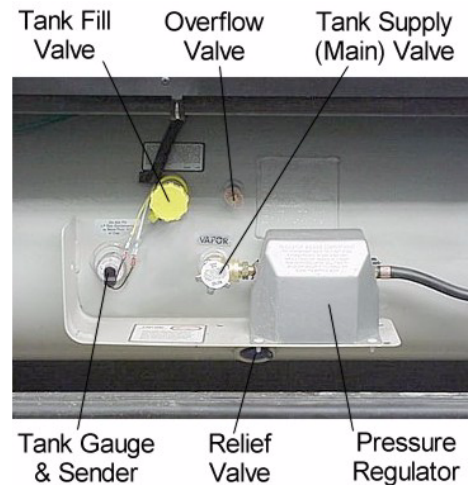

Propane Tank Features
-Typical View



WARNING

Do not alter or remove propane tank valves or gauge. Propane can escape, which can cause an explosion resulting in death or serious injury. Have the propane system serviced by a qualified service center.

Refilling Propane Tank

Since the propane tank is permanently mounted to the frame, the motor home must be taken to a propane dealership for filling. Do not attempt to remove the propane tank from the vehicle. The tank is equipped with a fill adapter with both internal and external threads, which allows easy filling with any propane filling equipment. The tank is full when liquid propane gas appears at the overflow valve.

NOTE: The propane tank is equipped with an automatic 80% stop-fill device.

 DANGER

DO NOT FILL CONTAINER TO MORE THAN 80 PERCENT OF CAPACITY. FAILURE TO COMPLY COULD RESULT IN A FIRE OR PERSONAL INJURY.

Make sure the motor home is level when filling. It is possible to accidentally overfill the tank if the vehicle is not level, with the fill valve on the uphill side. Overfilling the propane gas tank can result in uncontrolled gas flow, which can cause fire or explosion. A properly filled container will contain approximately 80 percent of its volume as liquid propane gas.

All pilot lights must be extinguished and appliances and their ignitors turned off, and supply valve closed before refilling propane gas tanks or vehicle fuel tanks.

Do not smoke or expose an open flame while near a propane refueling area. Propane gas is heavier-than-air and extremely flammable.

Never fill the propane tank with engine or generator running.

Before opening the supply valve, check to be sure all controls for gas appliances are in the “Off” or “Pilot Off” position. If this step is not performed, propane gas could accumulate inside the motor home creating a fire or explosion hazard.

Never use an open flame to test for propane gas leaks.

Replace all protective covers and caps on propane system before filling.

Selecting Propane Fuel Types

We recommend using straight propane in your propane tank. Propane gas is commonly available at all propane gas outlets in the U.S. (According to the National Propane Gas Association, propane gas outlets in the United States do not offer any other type of liquefied petroleum gas than propane to the general public.) Check local

phone directory yellow pages for locations of local propane gas refilling stations or bulk dealerships.

NOTE: If you travel outside the U.S. with your motor home, you may find butane or propane/butane mixtures available in addition to propane. Because gas-burning RV appliances are designed to run on propane only, we recommend that you request straight propane only. Butane burns about 30 percent hotter than propane and can overheat some appliances, particularly refrigerators, and cause permanent damage. Other appliances designed to operate on propane can become sooted and lose efficiency by using butane fuel.

Air in the Propane Gas Tank

If your gas appliances do not stay lit or require frequent adjustment, even though you know the propane tank contains sufficient fuel, the problem may be air in the propane gas tank. Air in the tank mixes with the propane gas vapors causing them to burn poorly. This condition could linger for weeks if the air is not purged from the tank. Most propane gas dealers have equipment for purging air from propane gas tanks and will purge before refilling the tank.

SAFE USE OF THE PROPANE GAS SYSTEM

The propane system is designed and built with strict adherence to national, state, and recreational vehicle industry requirements for mobile propane gas equipment.

For your safety, there are many safety devices and backup systems installed, such as tank fill overflow valves, an interior propane gas detector/ alarm, and an interior carbon monoxide (CO) detector/alarm.

Propane gas also contains an odor additive that you can smell if propane is present in the air.

Here are a few precautions to observe that will help you to use the propane gas system safely:

- Exercise caution at all times. Be familiar with the distinctive odor of propane gas. If a leak is suspected, turn off the supply valve immediately. Have the propane gas system checked by your dealer or other qualified propane gas service center.
- Do not tamper with the propane gas piping system, pressure regulator, or gas appliances. Service and maintenance of propane gas system components should be performed only by your dealer or a qualified propane gas service center.
- Never attempt to connect natural gas to the propane gas system.
- Have the entire propane gas system inspected for possible leaks and missing or damaged parts at each tank filling. Also inspect before and after each trip, and any time trouble is suspected.
- Turn the propane supply valve off when not using the propane gas system.
- Never use a wrench to tighten the tank supply valve. It is designed to close leak-tight by hand. If a wrench is required to completely close the valve, it is defective and must be replaced.
- Be sure appliance and outside vents are open and free from obstruction when using the propane gas system.
- Never attach a lock or any device requiring a key to the propane tank compartment door. According to standards set for recreation vehicles, the propane supply valve must be readily accessible in an emergency.
- Exercise caution when drilling holes or attaching objects to the walls. Gas lines and electrical wiring could be seriously damaged and present an extreme safety hazard.

PROPANE GAS WARNINGS AND PRECAUTIONS

It is illegal for vehicles equipped with propane tanks to travel on certain roadways or through certain tunnels in the U.S. To avoid inconvenience, check state regulations concerning flammable gas transportation.

Propane Gas Leaks

The following label is located in the vehicle near the range area. If you smell gas within the vehicle, quickly and carefully perform the procedures listed.

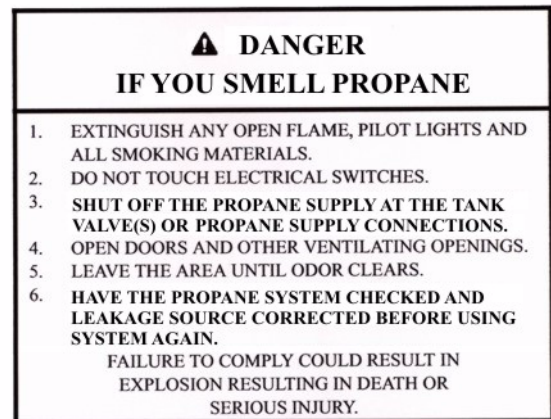

- All pilot lights must be extinguished and appliances and their ignitors turned off while refilling the fuel tank or propane tank.
- Never smoke while refilling vehicle fuel tank or propane gas tank.
- Avoid inhaling exhaust gases produced by burned gasoline, diesel fuel, or propane gas in items such as the range, chassis engine, generator engine, refrigerator, furnace, and water heater. They contain carbon monoxide, which is an odorless, colorless, and poisonous gas.

 WARNING

Propane cylinders shall not be placed or stored inside the vehicle. Propane cylinders are equipped with safety devices that relieve pressure by discharging propane to the atmosphere. Failure to comply could result in death or serious injury.

- Never use an open flame to test for propane gas leaks. Replace all protective covers and caps on propane system after filling. Make sure valve is closed and door latched securely.
- Portable fuel-burning equipment, including wood and charcoal grills and stoves, shall not be used inside the recreational vehicle. The use of this equipment inside the recreational vehicle may cause fires or asphyxiation.
- Regulators are equipped with a protective cover. Make sure that the regulator vent faces downward and that the cover is kept in place to minimize vent blockage, which could result in excessive gas pressure causing fire or explosion.

 WARNING

Visually inspect the pressure regulator vent periodically for blockage by accumulated debris or insect nests, etc. Vent obstruction could result in excessive pressure causing fire or explosion, which could result in death or serious injury. If an obstruction exists, have the regulator serviced by a qualified service center.

NOTE: If your model is equipped with a propane powered electrical generator, there will be two regulators stacked one upon another. One regulates the house propane supply pressure, the other regulates pressure to the generator.



PROPANE GAS PRESSURE REGULATOR

The pressure regulator is protected from the elements by a plastic cover, which should be left in place at all times.

Propane regulators must always be installed with the regulator vents facing downward. Regulators that are not in compartments have been equipped with a protective cover. Make sure that the regulator vent faces downward and that the cover is kept in place to minimize vent blockage that could result in excessive propane pressure causing fire or explosion.

Only your dealer or a qualified propane gas service should remove the regulator cover for adjustments.

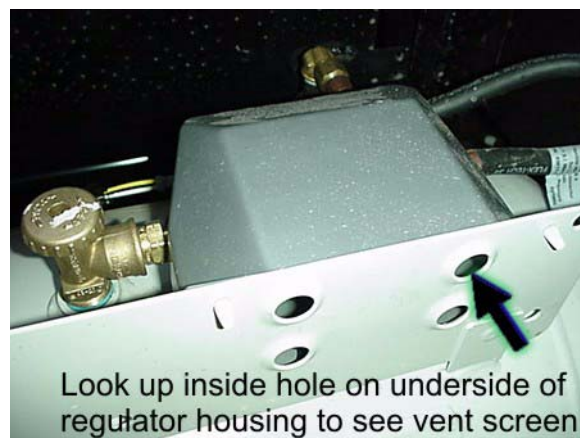

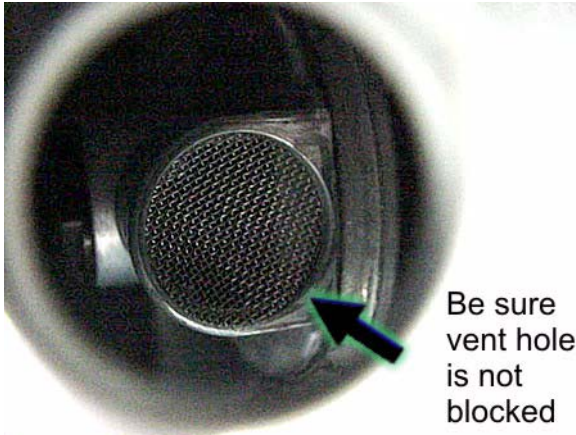

Regulator Freeze-up

Regulator freeze-ups are caused by the presence of moisture in fuel. This moisture will pass through the cylinder valve and into the regulator where it can freeze. Fuel producers, tank and bottle manufacturers, and propane gas dealers take every precaution to reduce moisture, but sometimes only a fraction of an ounce entering the tank can cause problems. To help avoid the possibility of freeze-up, always keep tank control valve closed when not in use, even when tank is empty, to prevent moisture from collecting on the inside.

If regulator freeze-up should occur, you may attempt to thaw the regulator using a light bulb. **DO NOT USE AN OPEN FLAME OR HEAT LAMP.**

If moisture begins to cause problems, have your propane gas dealer inject a small amount of dry methyl alcohol in your tank (approximately one ounce to 20 pounds or one pint to 100 gallons) to help guard against regulator freeze-ups.

PROPANE VAPORIZATION IN COLD WEATHER

Propane gas vaporization increases and decreases in direct relation to ambient temperature. In other words, the lower the temperature, the slower the liquid propane will vaporize into a usable gas for appliances.

This means that in extremely cold weather when a large volume of gas is being used by the furnace for heating, it is possible to experience a loss of gas pressure.

At first, this problem may appear to be caused by an empty tank or a regulator freeze-up, but is actually caused by failure of the liquid gas to vaporize as fast as it is needed by the furnace.

The demand for propane to produce heat increases to the point where the gas cannot vaporize fast enough to keep the furnace going. The only solution to this problem is to reduce gas usage where possible.

Adjusting the temperature on the gas/electric refrigerator may be a first step. Using less hot water will also help, as well as refraining from using the gas cooktop. A final step is to lower the thermostat setting to reduce gas usage by the furnace.

OUTLOOK

SECTION 6 – ELECTRICAL

Your coach is equipped with an electrical system consisting of two separate voltages:

- 12-volt DC system (battery current); and
- 120-volt AC system (household current)

The 12-volt system consists of two internal power sources, while the 120-volt system is operated from an outside power source or the optional 120-volt generator.

ELECTRICAL CAUTIONS

- Careless handling of electrical components can be fatal. Never touch or use electrical components or appliances while feet are bare, while hands are wet, or while standing in water or on wet ground.
- Improper grounding of the vehicle can cause personal injury. Do not plug the utility power cord into an outlet which is not grounded and do not adapt the plug to connect to a receptacle for which it is not designed.
- Do not attach an extension cord to the utility power cord.
- Be sure that all electrical appliances to be used contain 3-prong plugs for proper grounding.
- Avoid overloading electrical circuits. Replace fuses or circuit breakers with those of the same size and amperage rating only. Never use a higher rated fuse or breaker.
- Use caution when handling or working near electrical storage batteries. Always remove jewelry and wear protective clothing and eye covering. Avoid creating sparks.

ELECTRICAL SYSTEM – HOUSE 120-VOLT AC

The 120-volt system operates from the shoreline cord connected to an outside 120-volt utility service, such as those at campgrounds or from the 120-volt generator. When the shoreline cord is connected to an outside power source, or when the auxiliary electric generator is running,

the power converter automatically changes a portion of the 120-volt current to 12-volt DC current. All equipment in the motor home that is normally powered by the house batteries is then powered through the converter.

In addition, the following equipment is entirely dependent on 120-volt current: air conditioner, refrigerator (when placed in AC mode), microwave oven, and any 120-volt electrical equipment used at convenience outlets.

EXTERNAL POWER CORD (Shoreline)

The external power cord (commonly referred to as a “shoreline”) is stored in the utility compartment on the left (driver’s) side of the coach.



WARNING

Do not use an extension cord. Improper sized cords, damaged cords, and poor connections can lead to fire, which can result in death or serious injury.



WARNING

Do not connect the external power cord to any receptacle until you have verified proper polarity and grounding. Be sure that all three prongs of the supply cord are properly plugged into the receptacle. Failure to observe can result in death or serious injury.

The three-prong power cord is designed to ground the electrical system through the receptacle. It is also designed to carry the amperage output of most campground outlets. If the electrical receptacle to be used is designed to

mate with the three prongs on the power cord plug, the electrical connection can be expected to carry rated load.

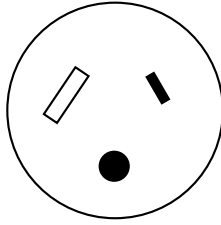

30 Amp Receptacle

Connecting the Power Cord

To connect to an external power source, remove the power cord from the utility compartment and plug it into a suitable power receptacle.

A passage through the compartment door or the bottom of the compartment lets you route the power cord out of the compartment so you can close the compartment door while the power cord is connected.

After disconnecting the power cord, neatly stow it in the utility compartment.

NOTE: Always keep service access passage closed while utility connection is not in use.

Park Fuses or Breakers

Most campgrounds are equipped with a fuse or circuit breaker at the receptacle. This protects the park’s wiring, as well as the power cord on your vehicle, from electrical damage. If electrical power fails, contact the park attendants and have them check the fuse or breaker for your supply receptacle.

POWER CENTER

(Converter)

The power converter is generally located in a lower cabinet face in the galley or living area, depending on the floorplan of your model.

The converter power panel contains the house electrical system 120-volt circuit breakers and 12-volt fuses.

The power converter changes 120-volt AC current from the auxiliary generator or the shoreline into 12-volt DC current for use by 12-volt equipment in the motor home.

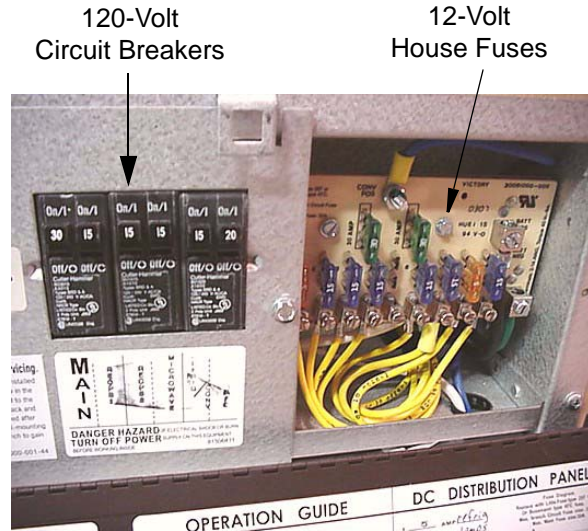

Power Center (Converter)

Certain circuits, however, remain unchanged for use by items which require 120-volt current, such as the air conditioner(s), the refrigerator in AC mode, the microwave oven, etc.

NOTE: The converter will not change 12-volt DC current to 120-volt AC.

Current drawn from the house batteries passes through the power converter unchanged, although it is routed through a series of protective fuses located on the power panel.

NOTICE

Do not block the converter cover vents in any way. The converter generates heat while operating and needs unrestricted airflow for proper cooling. Damage to the converter can result.

Further Information

See the manufacturer’s operation, care, and maintenance information in your InfoCase.

Charging Section

The converter charges house batteries while 120-volt external power is connected. The converter will automatically “sense” the condition of the battery. If it is below “full charge”, the Charging Section will start charging the batteries.

If the house batteries have been extremely discharged, they will accept charge at a relatively high amperage rate. If they are only slightly discharged, they will charge at a lower amperage rate. The rate of charge will decrease as the batteries reach “full charge”, then will continue “trickle” charging at a very low amperage rate. If your battery does not charge as described above, it is possible the battery is defective.

Thermal Overload

A thermal overload will “break” the 120-volt AC power to the converter section of the Power Center if the power converter becomes overheated. This can result from operating above its maximum limit for an extended period of time or by obstruction of ventilation to unit.

NOTE: The power converter section will automatically route 12-volt lights and motors to house battery power in this event.

The thermal overload will reset itself after a period of time, and the lights and motors will again resume operation from the power converter section. If the breaker trips again shortly after reset, take immediate steps to correct the cause of overheating. A portion of the house 12-volt load (lights or motors or both) should be turned off to reduce total load. Also, inspect the power converter to make sure ventilation is not obstructed.

CIRCUIT BREAKERS – HOUSE 120-VOLT AC

The breaker panel protects all 120-volt components in the motor home from either an overload on the circuit or a short in the wiring or

component itself. When an overload or short develops, the breaker will open preventing damage to the system.

Shut off the equipment (example: roof air conditioner) and allow a brief cooling period. Then reset the breaker by moving the switch to “Off” and back to “On”. If the breaker is continually tripped and no overload is evident, have the system checked for a short in the wiring or the appliances.

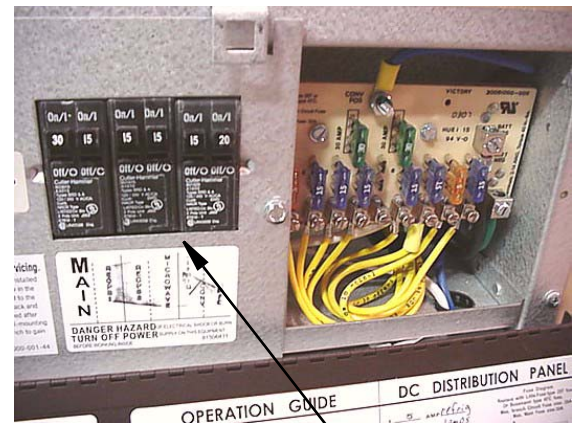

120-Volt Circuit Breakers

NOTE: Typical view of breaker panel. Breaker arrangement may vary according to appliance and equipment options. Fuses and breakers are labeled on panel.

ELECTRICAL OUTLETS – HOUSE 120-VOLT AC

A number of standard household electrical outlets are provided throughout the coach for connecting small appliances such as televisions, radios, toasters, etc.

An exterior outlet is also located on the outside of the coach near the entrance door or in a storage compartment on the passenger side of the coach.

GROUND FAULT CIRCUIT INTERRUPTER

Bath, galley, and exterior outlets are connected to a GFCI (Ground Fault Circuit Interrupter), which is an extremely sensitive circuit breaker that will help to protect against

severe electrical shock if a ground fault develops. If such a condition occurs, the GFCI will break the circuit by turning off the power to the protected outlets. Should this occur, unplug all the appliances on that circuit and press the reset button on the GFCI equipped outlet.

If the GFCI keeps tripping, have the electrical system checked and repaired, if necessary, before using again.



Push to Reset circuit after monthly testing or ground fault tripping.

Push to Test at least monthly. Should break circuit. Press Reset button to reconnect.

**GFCI Outlet
(Ground Fault Protector)**

! WARNING

The GFCI will not completely eliminate the risk of electrical shock. Infants and small children may still be affected.

**ELECTRICAL GENERATOR –
120-VOLT
–If Equipped**

! WARNING

Careless handling of the generator and electrical components can be fatal. Never touch electrical leads or appliances when your hands are wet, or when standing in water or on wet ground. Do not attempt to repair the generator yourself. Service should be performed by a qualified service center.

To use the 120-volt generator, plug the power cord into the generator receptacle within the utility compartment before starting the generator.

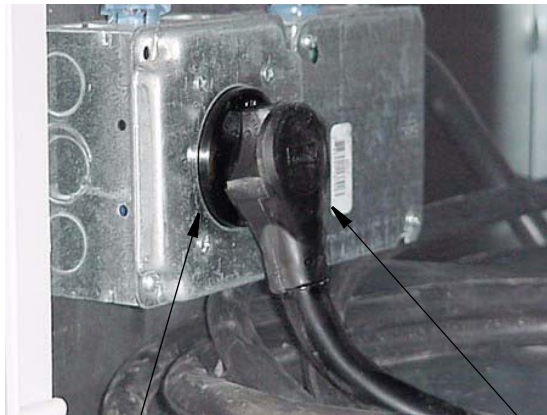

Generator Receptacle

Power Cord

! WARNING

Do not plug the power cord into the generator receptacle while the generator is running. Electrical shock can cause personal injury.

Generator Operation

See the manufacturer’s operation, care and maintenance in your InfoCase.

Generator Hourmeter

This meter is located on the monitor panel. It registers the total number of hours that the generator has been operated.

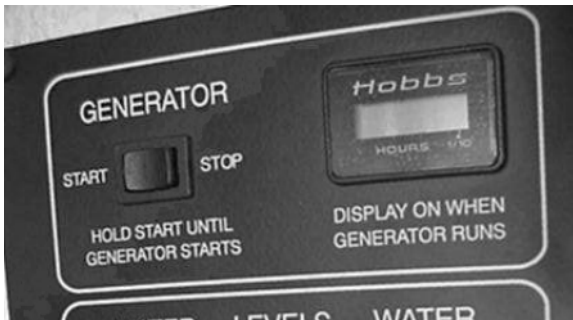

Refer to the hourmeter to determine when periodic maintenance is due and to record services which have been performed.

Operation Warnings and Cautions

 **WARNING**

The exhaust of all internal combustion engines contains carbon monoxide (CO). This poisonous gas is colorless, odorless, tasteless, and lighter than air. The exhaust systems of both your motor home engine and your generator engine have been installed with your safety in mind. However, certain precautions must be taken when using them to protect yourself from conditions beyond the control of the manufacturer.

1. Do not simultaneously operate the generator and a power vent, which could draw exhaust gases into the vehicle.
2. Do not open windows or vents on the end or side of the vehicle where exhaust pipe of the generator is located.

3. Park the vehicle so that the wind will carry the exhaust away from the vehicle. Also, note the position of other vehicles to be sure their exhaust will not enter your vehicle.
4. Do not operate the generator engine while parked if vegetation, snow, buildings, vehicles, or any other object can deflect the exhaust under or into the vehicle.

NOTE: Check auxiliary generator oil level frequently during periods of use.

Refer to the generator manufacturer’s maintenance information in your InfoCase for specific recommendations.

ELECTRICAL SYSTEM – HOUSE 12-VOLT DC

The DC voltage system consists of the chassis battery, the 12-volt house batteries, and the 12-volt power converter.

Converter

See “Power Center.”

Chassis Battery

The chassis battery is used to operate the engine starter and automotive accessories and controls found on the instrument panel. The slideout room systems and the electric step are also connected to the chassis battery.

See your chassis manual for further information on chassis batteries and chassis electrical system.

House Batteries

House batteries are “deep-cycle” type batteries specially designed for recreational vehicle use. They will provide longer lasting power than standard automotive starting batteries and will withstand the frequent drain-and-recharge cycles that occur under the demanding conditions of a camping outing.

The house batteries supply power to 12-volt equipment located in the living area of the motor home. This includes the following 12-volt powered components (if equipped): interior 12-volt lighting, range exhaust fan, propane furnace fan, fresh water pump, systems monitor panel

with water level and holding tank gauges, refrigerator, roof vent fans, and 120-volt electrical generator starter.

The house batteries can also provide emergency power to start the engine if the chassis battery is discharged. (See “Battery Boost Switch” or “Aux Start Switch”).

House batteries are automatically charged by the chassis alternator while the engine is running.

HOUSE BATTERY DISCONNECT SWITCH (HOUSE/COACH BATT)

The HOUSE/COACH BATT disconnect switch lets you disconnect the house batteries from the 12-volt system of your coach during storage periods to avoid battery drain by electrical items that are hooked directly to the house batteries, such as clock displays and radio memories, etc.

Always leave this switch ON while using the coach.

NOTE: Some electronic displays and memory functions may need to be reset after power has been reconnected.

See also “Battery Care” elsewhere in this section.



House/Coach Batt Disconnect Switch
(Located near entrance door or end of galley, depending on model)
-Typical View

BATTERY ACCESS

The house batteries are located in a compartment beneath the interior entrance steps.

Unfasten the step retainer, then lift the step upward and remove to service batteries.

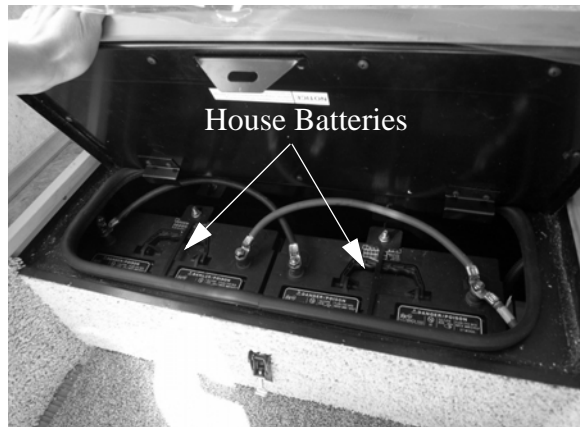

House Batteries
(Located beneath entrance step)
-Typical View

NOTICE

Always refasten battery retainers when returning a battery to the compartment.

BATTERY CARE

Lead-acid type batteries are electro-chemical devices for storing and releasing electrical charge. As such, they are simply an electrical

reservoir, not an electrical source. As soon as energy is removed from the battery, it should be replaced by the engine alternator or the RV converter system.

If a battery sits unused for 30 days or more, especially during warm weather, it can develop a deposit of sulfate crystals on the metal plates inside the battery. This condition is called “sulfating” and prevents the battery from either releasing or accepting a charge. If this condition occurs, the battery must be replaced.

If a battery does not contain at least 80% charge during freezing temperatures, the electrolyte can freeze and crack the battery case.

The two best defenses against sulfating and insufficient charge are to:

1. Turn off the House/Coach Battery Disconnect (House/Coach Batt) switch to avoid parasitic discharge (the trickle discharge caused by directly connected components like propane gas detectors or digital clock displays, etc.)
2. Check the battery and recharge as necessary at least once a month during long storage periods. Turn the House/Coach Batt Switch off to avoid electrical arcing when attaching or detaching charger clamps.

 **WARNING**

California Proposition 65 Warning: Battery posts, terminals, and related accessories contain lead and lead compounds, chemicals known to the state of California to cause cancer and reproductive harm. Wash hands after handling.

NOTE: We do not recommend leaving the shoreline plugged in continuously during storage periods because the batteries can lose electrolytic fluids and become damaged from continuous charging without periodic use or maintenance.

We recommend following regular battery inspection and maintenance, especially in cold weather.

Further precautions are:

- Remove the battery from the coach.
- Store it in a cool place.
- Check the state of charge periodically to avoid discharge or sulfating.

To ensure that the battery will always accept and hold a charge, follow these simple maintenance practices:

- Make sure the batteries always remain securely clamped in the battery tray.
- Make sure battery cable clamps are tight on the terminal posts and are free of corrosion.
- Neutralize corrosion buildup or acid film on top of battery by washing with a baking soda/water solution. Rinse with clear water.

NOTE: Make sure vent caps are on securely to prevent baking soda solution from entering the battery and contaminating the electrolyte fluid.

 **WARNING**

Before removing any battery cables or battery, make sure all 12-volt equipment in the motor home is off and the power cord has been disconnected. Be sure to replace the battery terminal boot, if supplied, back onto the positive terminal after servicing. Care must be taken to avoid pinching the cable between any metal parts. Should the cable be damaged, a short circuit could result in personal injury or damage to equipment. Replace any damaged cables at once. Always remove jewelry and wear protective clothing and eye covering when checking or handling batteries.

- Clean and tighten battery terminals and have the specific gravity checked at least once a year.

SECTION 6 – ELECTRICAL

- Check the battery fluid level every month, or more often in hot weather. Fill to approximately 3/8 inch above the plates. **DO NOT OVERFILL.** If fluid is added during freezing weather, the motor home should be driven several miles to mix water and electrolyte to prevent freezing.
- Fluid level check may be omitted if equipped with maintenance-free batteries.



WARNING

To prevent wiring damage, it is essential when replacing the cables on the battery, or when using a “booster” battery, that the positive post and the positive cable be attached and the negative post and negative cable be attached. The posts are marked (+) plus and (-) minus.

If a “boost charger” is used while battery is in the motor home, disconnect both battery cables before connecting the charger to avoid damage to engine electronic components.

Never attempt to charge or boost a frozen battery. An explosion can occur resulting in personal injury.



Chassis and House 12V Breakers in exterior storage compartment (remove cover to access)

A label on the panel states the amperage rating and circuit protected for each fuse or breaker.

12-Volt Fuse Panel

The fuse panel is on the right-hand side of the power converter.

12-Volt House Fuses

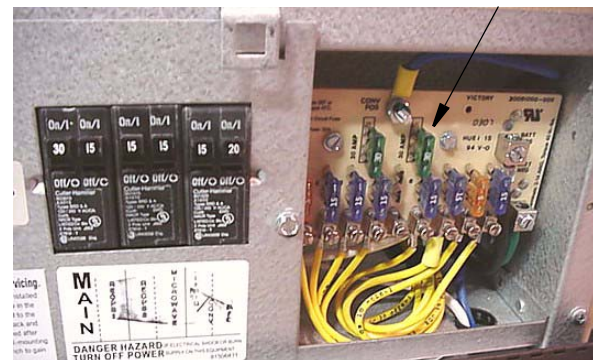

The fuse panel accepts only blade type plug-in fuses. Always replace fuses with those of the same amperage rating.

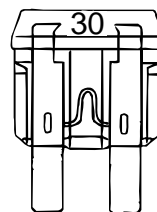

Good Fuse

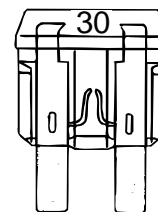

Bad Fuse

Battery Charge Meter

See related item under “Systems Monitor Panel” in Appliances section.

CIRCUIT BREAKERS AND FUSES – HOUSE 12-VOLT

All 12-volt circuits and equipment in the coach area of the motor home are protected by either a fuse panel or breaker panel. When a circuit is overloaded or a short develops in any part of the system, a fuse or breaker will shut down that circuit. If this happens, turn off all affected lights or appliances and reset the breaker or replace the fuse with a new one of equal amperage rating.

Battery Boost Switch

See Driving Your Motor Home section for information on the Battery Boost Switch.

OUTLOOK

SECTION 7 – PLUMBING

FRESH WATER SYSTEM

The fresh water system provides water to the galley sink, shower, bathroom lavatory, toilet and water heater. Water may be supplied by either of two sources:

- a fresh water tank and water pump located within the motor home, or
- any external fresh water source to which the motor home may be connected, known as “city water.”

Filling the Fresh Water Tank

Always fill the fresh water tank at an approved potable water filling facility or a known purified drinking water source.

The gravity tank fill tube is located behind a small, lockable door on the left (driver) sidewall toward the back of the coach.



Insert hose into fill opening and turn water supply on. Tank is full when water flows from tank vent tube beneath coach.

Using City Water

When connected to an outside source of water, the water bypasses the demand pump and storage tank and supplies pressure directly to individual faucets and toilet. A check valve built into the pump prevents water from entering the pump and filling the storage tank.

Connecting City Water Source:

1. Turn the demand pump switch to off.

2. Attach an RV city water hose from the external water source to the city water connection typically located in the water service compartment or on the left sidewall of your vehicle.



3. Turn on the external water source.

NOTE: Always keep the tank fill valve in Normal position unless you are filling the tank. If this valve is left in the Tank Fill position while using the city water, water will keep flowing into the tank and out the tank vent tube onto the ground and the water pump will run without delivering water to faucets.

Disconnecting from City Water

1. Turn the city water source off.
2. Open a faucet on the coach (such as the exterior wash station if equipped) to relieve line pressure.
3. Disconnect the city water hose from the coach and replace the cap on the fresh water inlet.

Pressure Regulators

Because city water pressure varies from location to location, we recommend obtaining an in-line water pressure regulator to prevent damage to any components, connections and seals in your fresh water system. We recommend a regulator that controls water pressure to **50 psi. max.**

These devices simply connect in-line between the supply hose and the city water input on the coach.

Water pressure regulators are commonly available at most RV dealerships and many large retail discount or home supply centers.

WATER PUMP

When your coach is not connected to a city water supply, water is supplied from the fresh water tank by a water system demand pump. A demand pump is designed to run only when you are using water. When you open a faucet, the waterline pressure drops and the pump begins to run, and it will continue to run as long as the faucet is open. When you close the faucet, the line pressure backs up to the pump, and it shuts itself off.

The pump is self-priming and will run briefly to build up line pressure when the Water Pump Switch is first turned on. See “Initial Waterline Priming” for instructions on using the water system for the first time.

Further Information

See the water pump manufacturer’s operation, care, and maintenance information in your InfoCase.

Pump Strainer

The pump is equipped with a cleanable strainer to capture any possible tank-borne particles that could damage pump components.

NOTE: We recommend that you check and clean the strainer after each tankful of water during the first few uses of the water pump system. Thereafter, remember to check it at least yearly, and be sure to empty water from it during winterization procedures.



Water Pump Strainer
-Typical View

To Clean Pump Strainer

- Be sure all water pump switches are OFF.
- Twist the inlet cap (bowl) counter-clockwise to unscrew from the strainer assembly.
- Remove the bowl and pull the strainer screen out of the bowl to tap out any particles and rinse clean.
- Insert the strainer screen back into the bowl, then screw the bowl back onto the strainer assembly.

NOTE: You must also empty the strainer when winterizing your coach to avoid water freezing and cracking the filter bowl.

Water Pump Switch

The water pump switch is located on the systems monitor panel. (Some models may have an additional switch in the water service center or within the bathroom area for your convenience.)

While the switch is “ON”, the pump will automatically supply water as it is needed.

We recommend that you turn the water pump switch off whenever you will be away from the vehicle or not using the water system. In time, a slow leak in a faucet could drain the water tank, fill the holding tank, and discharge the house batteries.

Initial Waterline Priming

1. Make sure that all water drain valves are closed, including water heater valve.

2. Turn water pump switch to “OFF” position.
 3. Fill water tank.
 4. Open all faucets, hot and cold.
 5. Turn on pump switch.
 6. Close each faucet as it begins to deliver a steady stream of water (close cold water first). Leave hot water faucets on until they also deliver a steady stream of water. This will ensure that the water heater is filled with water.
 7. Check to be sure pump stops soon after all faucets have been closed.
 8. Pump is now ready for automatic operation. Pump will start when a faucet is opened and stop when the faucet is closed.
- Place a container beneath the filter to catch any water remaining in the waterlines during filter removal.
 - Twist the filter cartridge counter-clockwise (to the left) about one-quarter turn, then pull it down and out of the filter socket.
 - Insert a new water filter cartridge up into the filter socket as far as possible and twist it clockwise (to the right) one-quarter turn until it stops.

COLD WATER FILTER

–If Equipped

Open the galley sink cold water faucet only to obtain filtered cold water for drinking or cooking.

The galley faucet cold waterline flows through an activated carbon filter that removes chlorine and odors for taste-free drinking water.



Cold Water Filter Assembly below Galley Sink
(Hot waterline is not filtered)

Replacing the Cold Water Filter Cartridge

You should replace the filter cartridge every season and when water flow from the faucet is too slow for convenience. The cartridge **MUST** be replaced at least every 12 months.



Insert new filter up into filter socket –
Press and twist 1/4-turn clockwise
(to the right).

- Purge a new filter cartridge before using for drinking. Run a few gallons of water through the filter and discard the water (or use for watering plants) to avoid ingesting carbon dust or particles that may have been present in the new filter cartridge.

Diverter Plug

- The temporary diverter plug is provided to prevent water flow from the filter base in situations when the waterline must be used with the filter removed, such as winterization or lack of spare filter cartridge.
- Diverter plug is installed in the same manner as the filter.



Diverter Plug installed in filter socket. Insert and twist 1/4-turn clockwise (to the right), same as filter installation.

- See Winterization Procedure at the end of this section.
- When removing the coach from storage, always disinfect and flush the water system thoroughly before installing a new filter. After the system has been thoroughly flushed, remove the diverter plug and store for future use.

DISINFECTING YOUR FRESH WATER SYSTEM

To assure complete disinfection of the potable water system, it is recommended that the following procedure be followed on a new system, one that has not been used for a period of time, or one that could have become contaminated.

This procedure is also recommended before long periods of storage such as over winter.

1. Prepare a chlorine solution using 1 gallon of water and 1/4 cup of household chlorine bleach (sodium hypochlorite solution). With tank empty, pour chlorine solution into the tank. Use 1 gallon solution for each 15 gallons of tank capacity. This procedure will result in a residual chlorine concentration of 50 ppm in the water system.

If a 100 ppm concentration is desired as discussed in step 4, use 1/2 cup of household bleach with 1 gallon of water to prepare the

chlorine solution. One gallon of this solution should be used for each 15 gallons of tank capacity.



WARNING

Chlorine is poisonous. Do not misuse. Recap bottle and clean all utensils after use.

2. Complete filling of tank with fresh water.
3. Open each faucet in the coach and run the water until a distinct odor of chlorine can be detected in the water discharged. Do not forget the hot water faucets.
4. Let the system stand at least 4 hours when disinfecting with 50 ppm residual chlorine. (*If a shorter time period is desired, then a 100 ppm chlorine concentration should be allowed to stand in the system for at least 1 hour.*)
5. Drain the water tank and refill with fresh water.
6. Open each faucet again and run fresh water to flush chlorinated water from the lines. Run the water until there is no odor of chlorine detected in the water discharged. Do not forget the hot water faucets. (*You may need to leave a hot water faucet open for some time to flush the water heater with clean water. You may also want to turn the water heater off until this is done to avoid wasting energy trying to heat “unused” water.*)
7. Water system is now disinfected.

Continuous Tank Disinfection (Superchlorination)

Some RVers like to ensure continuous sanitation of their fresh water tank by “superchlorination”—maintaining an effective low level of chlorine in the tank at all times.

- Add 1 teaspoon of household chlorine bleach (sodium hypochlorite) to your tank for each 10 gallons of tank capacity. When you fill the

tank, this will result in a 6.7 ppm level of chlorine, which should kill harmful bacteria and slime-forming organisms.

- Chlorine may be removed from drinking water by the cold water filter at the galley faucet (if equipped) or by installing an activated carbon water purifier at the galley sink cold water line or a separate drinking water faucet with filter.
- Superchlorination does not affect city water usage, only the fresh water tank.

SHOWER HOSE VACUUM BREAKER

After using the shower, you may notice water dripping from the shower faucet assembly. The dripping results when vacuum in the shower hose (after closing the shower faucet) slowly releases and allows water remaining in the hose to drain down. This is a normal function of the shower valve assembly and is not a leak or defect.

If items are placed into the shower tub before shower valve vacuum release is complete, they may become wet.

EXTERIOR SHOWER/WASH STATION

–If Equipped

The exterior wash station feature allows you to do things such as rinse off sand or salt after a swim, rinse off muddy boots, or bathe your pet outside the coach. Some models may have a water pump switch located near the shower faucet for convenience.



Exterior Shower/Wash Station
-Typical View

TOILET

The toilet in your motor home is very similar to the household type, except that it is designed to use only a small amount of water per flush. It uses a high velocity jet of water, producing a swirl effect, to efficiently cleanse the bowl.

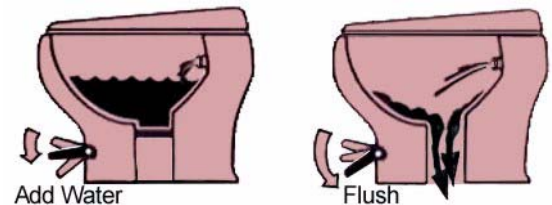

Important “Don’ts”

- Don’t use facial tissue or regular toilet tissue in the RV toilet. These will not disintegrate sufficiently and will often cling to the sides of the holding tank. Toilet tissue made specifically for use in RV toilets and holding tanks is available at most RV supply centers.
- Don’t dispose of sanitary napkins or other non-dissolving items in the toilet.
- Don’t put automotive antifreeze or caustic chemicals, such as laundry bleach or heavy detergents into the toilet or holding tank. These products may damage plastic or rubber parts in the system.

See winterizing instructions at the end of this section to prepare the toilet for storage in freezing conditions.

Further Information

See the toilet manufacturer's operation information in your InfoCase for complete operating, care, and maintenance information.

WASTE WATER SYSTEM

(Holding Tanks)

The drainage system is self-contained and uses two separate holding tanks to contain the waste water until it can be dumped at an appropriate waste water disposal site. This means you can use the toilet, sinks and shower even in areas where utility hookups are not available.

The black water holding tank contains the sewage from the toilet and may include bathroom lavatory on some models. The gray water holding tank contains the waste water from the galley sink and shower, and may include bathroom lavatory.

See *Specifications* in Section 1—Introduction for tank capacities for your model.

Dumping Holding Tanks

1. Remove drain hose from water service center.
2. Remove dust cap from drain and connect sewer hose. Be sure it is firmly attached.

NOTE: The dump valve drain outlet swivels downward when necessary to avoid bends in the drain hose which could trap solids while dumping or to provide more direct drainage while using on-site sewer hook-ups.

3. Place the outlet end of sewer hose into disposal opening.



Holding Tank Dump Valves (Typical)

Note: Black and Gray tank valve positions may be reversed depending on floorplan and tank location.

The center outlet section may be swiveled downward for better hose alignment and drainage.

4. Open the black water valve (black handle) with a quick pull and make sure there are no sags in the hose. Move the hose gently about to dislodge any waste and ensure complete drainage. Close black water valve as soon as tank is empty.

NOTE: DO NOT OPEN BOTH VALVES AT ONCE. Do not open the gray tank valve until the black tank is drained and dump valve closed to avoid sewage back-up into gray tank. Gray water also rinses any black water solids from the drain hose.

5. Open the gray water valve (gray handle). Be sure there are no sags in the hose to ensure complete drainage. Close gray water valve as soon as tank is empty.
6. Add an odor control chemical to the sewage holding tank through the toilet. These chemicals are available at most RV stores.
7. Rinse sewer hose thoroughly with water and stow.

NOTE: We recommend that you dump all holding tanks before traveling to avoid carrying unnecessary weight.

Using On-Site Sewer Hook-Ups

The drain hose may remain attached to the dump outlet and be routed out the bottom of the compartment while the motor home is parked and connected to an on-site sewage hook-up.

The center outlet section may be swiveled downward for better hose alignment and drainage.

NOTE: Always keep service access passage closed while utility connection is not in use.

When using a sewer hook-up, keep the dump valves closed until a tank becomes full or when preparing to leave the site. This keeps the solids in suspension, allowing them to be carried out with the liquids when the dump valve is opened. If the valve is left open, the liquids will drain off, leaving solids in the tank. Should this accidentally happen, disconnect the hose, fill the tank about half full with water, and drive a few miles to dislodge the solids. A few starts and stops will aid in the process. Then reconnect the hose and drain in the normal manner.

Holding Tank Level Indicators

See *Systems Monitor Panel* in Section 4–Appliances for further information on the monitor panel and checking tank levels.

See *Specifications* in Section 1–Introduction for tank capacities for your model.

HOLDING TANK HEATER

–If Equipped

Your coach may be optionally equipped with black water and gray water holding tank heaters to allow use of waste utilities in freezing temperatures. The holding tank heater power switch is located near the monitor panel. The illuminated switch will glow when the power is on.



DO NOT operate the holding tank heater unless you are providing a supplemental 12-volt power source to recharge the house batteries. This means either the shoreline cord must be plugged into a 120-volt source, or the auxiliary generator must be operating, or the chassis engine must be running (such as when driving down the road). This will prevent excessive discharge of the house battery.

NOTE: The holding tank heater pads are electrical resistance type heating elements. This type of heating element typically uses a large amount of current while operating. If the tank heaters are used without a recharging source, they will drain the house batteries in a relatively short period. Typically the batteries would not support overnight heating without a supplemental charging source.

WATERLINE & TANK DRAIN VALVES

The water drain valves are used to drain water from the water tank and the water supply lines when preparing the motor home for storage or when sanitizing the water system.

To open or close the drain valves, turn the handles in the directions indicated by the following illustration.

See the drain valve location chart at the end of this section for locations on your model.

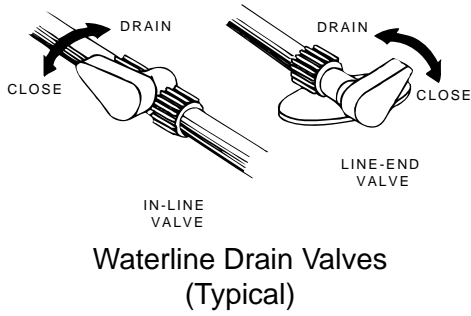

Waterline Drain Valve (Typical)



Water Tank Drain Valve (Typical)

WATER HEATER BYPASS VALVE

Your coach may be equipped with a water heater bypass valve for easier winterization of water lines using RV antifreeze. See table at the end of this section for valve location.

Turn the handle as shown to either bypass or flow through the water heater.

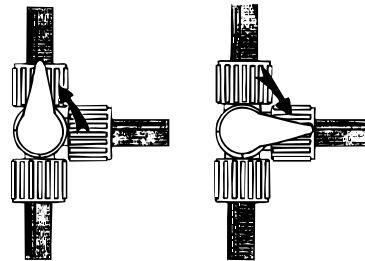

**Normal
Flow**

**By-Pass
Mode**

Leave bypass valve handle in **NORMAL FLOW** position if draining water and blowing out waterlines. Place in **BYPASS** position **ONLY** when using antifreeze solution in waterlines.

WINTERIZING PROCEDURES

You can winterize the water and plumbing system of your coach using one of the following two methods – 1) Blow out waterlines using compressed air or – 2) Fill waterlines with RV water system antifreeze.

Method 1 – Blow Out Procedure (Drain and purge waterlines using compressed air)

1. **Level the Motor Home.** If the coach is not level, there may be “low points” in waterlines that can trap water in the lines and prevent it from draining properly.
2. **Drain Fresh Water Tank and Waterlines.** Open all waterline drain valves and drain fresh water tank. (See “Water System Drain Valve Locations” chart at end of this section for locations of drain valves on your model).
3. **Drain Exterior Shower/Wash Station.** Open exterior shower knobs and lay shower head on ground as shown to drain any water left in the shower line. Also, place the tip of your finger into the city water inlet and gently press the backflow valve “button” in the center of the inlet to drain any water trapped in the inlet line.



Using exterior shower to drain waterline
(Typical View - appearance on your coach may differ)

4. **Remove the Cold Water Filter Cartridge (if equipped).** Remove the filter cartridge from the filter assembly below the galley sink. *(If your coach is not equipped with a cold water filter, continue to next numbered step.)*
 - Place a container beneath the filter to catch any water that may drain from the waterline during filter removal.
 - Twist the filter cartridge counter-clockwise (to the left) about one-quarter turn, then pull it down and out of the filter socket. Discard used filter.



- Install the diverter plug into the filter socket. Insert plug up into the filter socket as far as possible and twist clockwise (to the right) one-quarter turn until it stops.

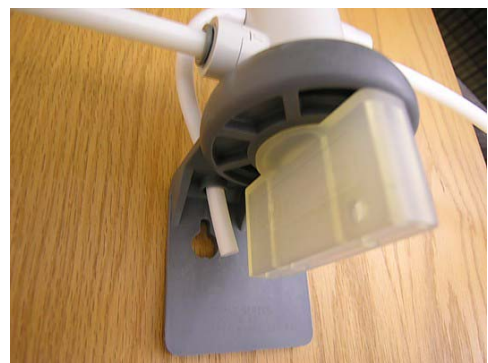

5. **Remove Full-Coach Water Filter (if equipped).** Remove the filter canister from the full-coach water filtration system in the water center compartment and discard the filter cartridge. *(If your coach is not equipped with a full-coach water filtration system, proceed to the next numbered step.)*

After emptying the canister, remount it onto the filter assembly and continue the blow-out procedure.

6. **Open Faucets.** Turn on the water pump and open all sink faucets and shower head knobs. Leave open after water stops flowing.
7. **Drain Toilet.** Press the toilet flush pedal and hold until water stops flowing in the toilet. Then turn water pump switch off.
8. **Drain Optional Appliances.** At this time, if your coach is equipped with an optional refrigerator ice maker, dishwasher, or washer/dryer, the waterlines for these appliances must also be drained.
(See “Winterizing Optional Appliances” instructions at the end of this section.)
If not, proceed to the next step.
9. **Drain Water Heater.** Turn off the water heater power switch before draining the water heater tank to avoid damage to the heating element. Drain the water heater by removing the plug from the base of the water heater tank, accessible from the outside of the coach.
(Requires socket and ratchet).

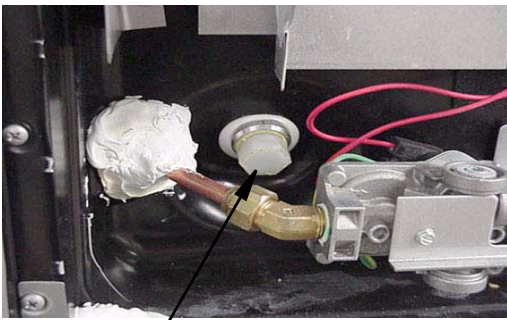

Water Heater Drain Plug
(Remove with socket)

Also, open the Pressure-Temperature relief valve at the top right portion of the tank to prevent air locking in the tank while draining.

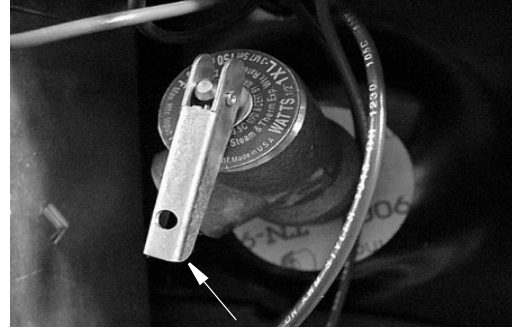

Lift handle only when water heater is cold

10. **Connect Air Pressure.** After water has stopped draining at all faucets and drain valves, leave faucets open and connect a “blow-out” plug to the city water connection on the coach. Then use a compressed air hose regulated to 30 psi or less to force air through the system. A “blow-out” plug can be purchased at any Winnebago® or Itasca® dealer.

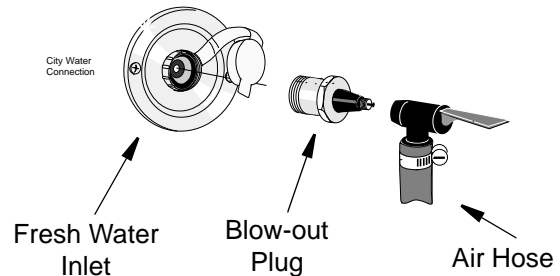

NOTICE

Limit air pressure to 30 psi to avoid damage to equipment.

NOTE: DO NOT burst air into the system. This can damage the water pump. It is better to let air in slowly.

11. **Let air flow for five minutes** until water is completely drained out of faucets and drain valves. Then close faucets one at a time.
12. **Drain Toilet.** Operate and hold toilet flush lever until water is completely drained from toilet.

13. **Turn air pressure off.** Disconnect water purge adapters. Recap the city water inlet to avoid contamination by dirt or insects.

After Disconnecting Air Pressure

14. Empty the full-coach water filter canister of any water trapped during blow-out procedure. Remount empty canister onto filter assembly. *(If not equipped with a full-coach water filter system, continue to next step.)*
15. Close all waterline drains, tank drain valves, and all faucets to avoid contamination by dirt, insects, or rodents.
16. Reinstall the Water Heater drain plug and close the P-T Relief Valve.
17. Pour about one cup of RV antifreeze down each drain for the galley sink, lavatory sink, and shower/tub. This fills the drain trap pipes to prevent holding tank odors from entering the coach during storage.

NOTE: It is not necessary to add antifreeze to the toilet since the flush valve will be closed. Do not add automotive antifreeze or caustic chemicals such as bleach or laundry detergents into the toilet bowl or holding tanks. Although these products may have a deodorizing effect, they may damage plastic and rubber parts in the system.

18. Empty the water pump strainer filter bowl to avoid water freezing and cracking the filter bowl. See “Water Pump” previously in this section.

Dump and Clean Holding Tanks

19. Completely drain the sewage and waste water holding tanks at an approved waste disposal site. Drain the sewage tank first so the following waste water can rinse any waste solids from the dump outlet and sewer hose.
20. Flush the sewage tank using the Black Waste Tank Flush Inlet (if equipped).

21. Close dump valves and refit the dust cap onto the drain outlet.

This will inhibit rust formation on valve shafts and prevent entry and contamination by airborne debris, insects, and rodents.

Your drainage and fresh water systems are now totally winterized.

See instructions for removal from storage in Maintenance Section.

Method 2 – Antifreeze Fill Procedure

(Fill plumbing lines with RV water system antifreeze)

NOTE: As an alternative to totally draining the waterlines, you may winterize tanks and lines by filling them with non-toxic RV water system antifreeze through the plumbing system.

This product is available from your dealer and from most RV supply stores and national retail outlets.

Follow directions on the container to determine the correct amount to use for your coach.

Your coach is equipped with a manually operated waterline winterization system for your convenience in winterizing fresh waterlines.

The system features a diverter valve with siphon tube to draw non-toxic RV water system antifreeze into the waterlines. There is also a water heater bypass valve to avoid filling the water heater with antifreeze. This feature is located near the water pump in the water center or utility compartment.

Leave bypass valve in NORMAL FLOW position if draining water and blowing out waterlines. Place in BYPASS position ONLY when using antifreeze solution in waterlines.

! WARNING

NEVER use automotive antifreeze/coolant in your RV water system. Automotive coolant/antifreeze contains ethylene glycol which, if ingested, can cause blindness and can be fatal.



Remove Water Filters

Before pumping RV antifreeze into water system, remove water filter cartridges (if equipped.)

1. Remove and discard the filter cartridge from the cold water filter assembly below the galley sink. *(If your coach is not equipped with filtered cold water, continue to next numbered step.)*
 - Place a container beneath the filter to catch any water remaining in the waterlines during filter removal.
 - Twist the filter cartridge counter-clockwise (to the left) about one-quarter turn, then pull it down and out of the filter socket.



- Install the diverter plug into the filter socket. Insert plug up into the filter socket as far as possible and twist clockwise (to the right) one-quarter turn until it stops.

2. Remove the filter canister from the full-coach water filtration system in the water center compartment (if equipped) and discard the filter cartridge. *(If your coach is not equipped with a full-coach water filtration system, proceed to the next numbered step.)* After removing filter, remount the empty canister onto the filter assembly and continue the antifreeze fill procedure.

Set Up Winterization Valves

3. Turn Winterization Valve 1 to “Water Heater Bypass” position to avoid filling water heater with antifreeze.



See Water System Drain Valve chart at the end of this section for location on your coach

4. Place handle of Winterization Valve 2 in the “Winterize” position.



See Water System Drain Valve chart at the end of this section for location on your coach.

- Remove and save the protective cap from the end of the antifreeze siphon tube (which connects to Winterization Valve 2). Insert the end of the siphon tube into a pail or other container with 2 to 3 gallons of non-toxic RV antifreeze solution.

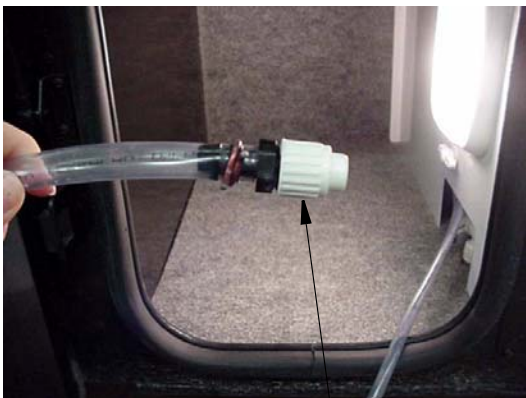

RV Antifreeze Siphon Tube
in water center or near water pump
(insert into container of RV water system antifreeze)

Fill Lines

- Turn the water pump switch on.
- Open each hot and cold water faucet handle/knob in the coach – one at a time each in turn until antifreeze solution just begins to flow from the faucet, then close.
Do not forget exterior shower/wash station knobs (if equipped.)
- Press the toilet flush pedal and hold until antifreeze begins flowing into the toilet. Leave small amount of antifreeze that remains in the bowl.

When Done Adding RV Antifreeze

- Turn water pump switch off.
- Turn the Winterization Valve 2 to Normal.
This will stop the flow from the suction tube and revert the tank line flow to the pump.
- Replace the protective cap onto the end of the antifreeze siphon tube to keep out insects or debris when not in use.

Drain Water Heater

- Turn off the Water Heater power switch before draining the water heater tank to avoid damage to the heating element.
 - Drain the water heater by removing the plug from the base of the water heater tank, accessible from the outside of the coach. (Requires socket and ratchet.)



Water Heater Drain Plug
(Remove with socket)

- Also, open the Pressure-Temperature relief valve at the top right portion of the tank to prevent air locking in the tank while draining.



Lift handle only when water heater is cold

- Reinstall the water heater drain plug and close the P-T relief valve when drained.

Drain Appliances

13. At this time, if your coach is equipped with an optional refrigerator ice maker, dishwasher, or washer/dryer, the waterlines for these appliances must also be drained. (See “Winterizing Optional Appliances” instructions at the end of this section.) If not equipped with optional appliances, proceed to the next step.

Close All Drain Valves

14. Close all waterline drains and tank drain valves to avoid contamination by dirt, insects, or rodents.
15. Pour about one cup of RV antifreeze down each drain for the galley sink, lavatory sink, and shower/tub. This fills the drain trap pipes to prevent holding tank odors from entering the coach during storage.

Dump and Clean Holding Tanks

16. Completely drain the sewage and waste water holding tanks at an approved waste disposal site. Drain the sewage tank first so the following waste water can rinse any waste solids from the dump outlet and sewer hose.
17. Flush the sewage tank using the Black Waste Tank Flush Inlet (if equipped).
18. Close dump valves and refit the dust cap onto the drain outlet.
This will inhibit rust formation on valve shafts and prevent entry and contamination by airborne debris, insects, and rodents.

To Winterize the Waste Pump

-If Equipped

- Make sure that black and gray holding tanks are completely empty.
- Pour about one cup of RV antifreeze down the toilet and either the bathroom or kitchen sink.
- Press and hold the macerator switch for about 5-10 seconds to get antifreeze into the macerator pump.

Your drainage and fresh water systems are now totally winterized. See instructions for removal from storage in Maintenance Section.

**WINTERIZING OPTIONAL
APPLIANCES**

**Winterizing Ice Maker
-If Equipped**

When winterizing, make sure the waterline is completely drained by following this procedure.

1. Drain coach waterlines.
2. Unscrew the water supply line from the bottom of the water inlet valve and drain any water left in the line. This connection is located in the refrigerator service compartment on the outside of the coach. (See Refrigerator Service Access Compartment in Appliances & Systems section.)

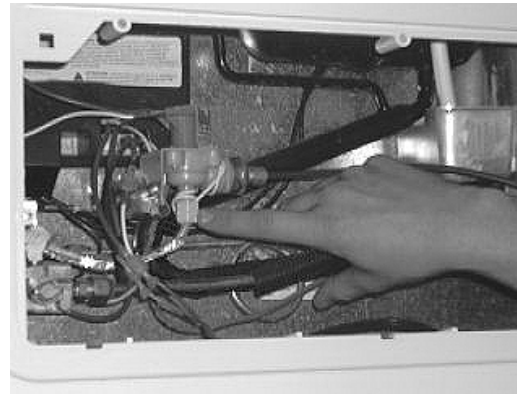

Ice Maker Water Supply Connection

3. Let the ice maker run through a cycle, then raise the shut-off arm.
4. Be sure water has drained from ice maker supply line, then reconnect to inlet valve.
5. Ice Maker is now winterized.
Go to next optional appliance or go back to Blow Out Procedure Step 9 - Drain Water Heater or Antifreeze Fill Procedure Step 14.

To use Ice Maker again:

Flush antifreeze from the waterlines, then

1. Close all drain valves.
2. Turn the water supply on.
3. Be sure the ice bin is in place and the automatic shutoff arm is down.
4. Let the refrigerator cool down to ice making temperature. Remember, this can take up to 24 hours.

5. Let the ice maker cycle and dump the first batch of ice.

Winterizing Washer/Dryer –If Equipped

Method 1 – Drain Water

If you've decided to completely drain the waterlines, follow these steps to winterize your washer/dryer:

1. With the machine power OFF, pour 1/2 quart of RV-type antifreeze into the washer drum.
2. Close the door. Advance the Program Selector knob to a SPIN position.
3. Press ON/OFF Button (IN). Wait 1-2 minutes.
4. Press ON/OFF Button (OUT). Unplug the washer/dryer from the electrical outlet (or disconnect power).
5. Turn the water supply faucets OFF. Disconnect the inlet hoses from the faucets. Drain any remaining water from the hoses.
6. Washer/Dryer is now winterized. Go to next optional appliance or go back to Blow Out Procedure Step 9 - Drain Water Heater or Antifreeze Fill Procedure Step 14.

Method 2– Fill with RV Antifreeze

If you've decided to fill the waterlines with RV antifreeze, follow these steps to winterize your washer/dryer:

1. With the machine power OFF, turn the WASH TEMP knob to HOT.
2. Advance the Program Selector knob to REGULAR in Cotton Heavy Duty.
3. Press the ON/OFF button (IN) and let the machine fill until antifreeze is in the drum.
4. Advance Program Selector to a RESET. Wait 5 seconds (Status/Door Lock LED will blink).
5. Advance Program Selector to a SPIN position. Let the antifreeze drain from the drum.
6. Advance Program Selector to RESET. Wait 5 seconds (Status/Door Lock LED will blink).
7. Turn the WASH TEMP knob to COLD.
8. Advance the Program Selector knob to REGULAR in Cotton Heavy Duty.

9. Let the machine fill until you see antifreeze in the drum.
10. Advance the Program Selector knob to RESET. Wait 5 seconds (Status/Door Lock LED will blink).
11. Advance the Program Selector knob to SPIN. Let the antifreeze drain from the drum.
12. Press the ON/OFF button (OUT).
13. Washer/Dryer is now winterized. Go to next optional appliance or go back to Blow Out Procedure Step 9 - Drain Water Heater or Antifreeze Fill Procedure Step 14.

To use Washer/Dryer again: Flush antifreeze from the waterlines, then

1. Reconnect the water inlet hoses to the corresponding HOT/COLD faucets. Turn the faucets ON. (NOTE: Check the water inlet hoses and pump periodically. Refer to the "Use & Care Guide" that came with the machine.)
2. Plug the washer/dryer into an appropriate electrical outlet (or reconnect power supply).
3. With the ON/OFF button in the off (OUT) position, pour 1/2 TBSP. of powder detergent (or liquid equiv.) into the "Detergent" compartment inside the Dispenser Drawer.
4. Advance the Program Selector knob to an EXPRESS cycle.
5. Press the ON/OFF button (IN) and allow the machine to run through the complete cycle to clean out any remaining antifreeze.

Winterizing Dishwasher –If Equipped

Follow dishwasher manufacturers instructions for operating and for interrupting cycles.

1. Empty all dishes from the dishwasher.
2. Follow coach winterization instructions for using the winterization valve to draw RV water system antifreeze into the water system so antifreeze can enter the dishwasher.
3. Set the dishwasher controls to the start of the Rinse cycle and run briefly until antifreeze can be seen inside the dishwasher.

4. Set the controls to the end of the Rinse cycle to pump the liquid out of the dishwasher to make sure the lines and pump contain antifreeze.
5. Turn dishwasher controls to Off.
6. Pour about a quart of RV water system antifreeze directly into the dishwasher to ensure protection of pump and drain lines.
7. Dishwasher is now winterized.
Go to next optional appliance or go back to Blow Out Procedure Step 9 - Drain Water Heater or Antifreeze Fill Procedure Step 14.

**To use Dishwasher again:
Flush antifreeze from the waterlines, then**

1. Set the dishwasher controls to the start of the Rinse cycle and run briefly until antifreeze can be seen inside the dishwasher.
2. Set the controls to the end of the Rinse cycle and allow the machine to run through the complete cycle to clean out any remaining antifreeze.

WATER SYSTEM DRAIN VALVE LOCATIONS		
Model	System	Drain Valve Locations
Model 29B	Waterlines	<ul style="list-style-type: none"> • Two (2) drain valves located in compartment behind passenger side rear wheels. • One (1) valve in 2nd driver side storage compartment.
	Water Tank	<ul style="list-style-type: none"> • In 2nd driver side storage compartment.
	Water Heater	<ul style="list-style-type: none"> • Drain plug on outside of coach behind service door. Use socket to remove drain plug.
	Water Heater Bypass Valve	<ul style="list-style-type: none"> • In rear wardrobe. Remove lower left drawer to access.
	Winterization (Antifreeze) Valve	<ul style="list-style-type: none"> • In 2nd driver side storage compartment.
	Exterior Shower	<ul style="list-style-type: none"> • Lay shower head on ground and open faucet valves to drain lines and hose.
Model 31C	Waterlines	<ul style="list-style-type: none"> • Two (2) drain valves beneath the removable bottom panel in the bathroom lavatory cabinet.
	Water Tank	<ul style="list-style-type: none"> • One (1) valve beneath bed. Lift head of mattress to expose access hole.
	Water Heater	<ul style="list-style-type: none"> • Drain plug on outside of coach behind service door. Use socket to remove drain plug.
	Water Heater Bypass Valve	<ul style="list-style-type: none"> • In bottom of refrigerator cabinet. Remove panel to access.
	Winterization (Antifreeze) Valve	<ul style="list-style-type: none"> • Beneath bed. Lift head of mattress to expose access hole.
	Exterior Shower	<ul style="list-style-type: none"> • Lay shower head on ground and open faucet valves to drain lines and hose.

OUTLOOK

SECTION 8 – ENTERTAINMENT

VIDEO SELECTION SYSTEM

-If Equipped



The video selection system allows you to switch the antenna, AUX/VCR, cable TV, satellite TV, or DVD signal to any TV set location in the coach.

This means one person can watch a program coming in on the roof antenna on the bedroom TV while another person watches a satellite or cable TV program or video on the front TV.

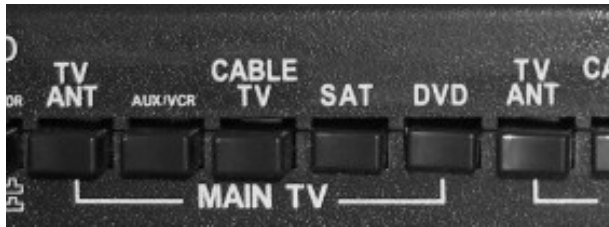

To Watch Broadcast TV (Antenna)

- Press TV ANT button on MAIN TV section of Video Selection System panel.

To Watch Cable TV

- Press CABLE TV button on MAIN TV section of Video Selection System panel.

To Watch Satellite TV (Dish)

-If Equipped

- Press SAT button on MAIN TV section of Video Selection System panel.

To Watch DVD

- To watch a DVD on your main TV, change the TV to either Channel 3 or 4 by pressing the button with “Modulator” marked above the switch and “Ch. 3/Ch. 4” marked below the switch. If the switch is pressed in, you tune to channel 4. If the switch is not pressed in, you tune to Channel 3.

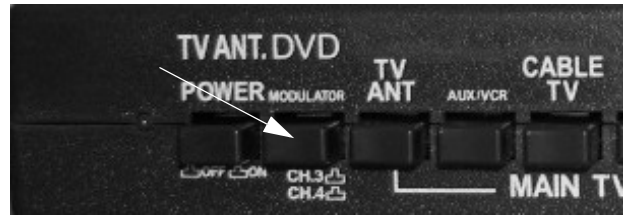

- The Video Selection System allows you to watch DVD's from either the lounge area (main TV), bedroom, or the exterior entertainment center (if equipped). Press the button with “DVD” marked above the switch and “Main TV” marked below the switch. To watch a DVD on other TV's, press the button “DVD” marked above the switch in the corresponding section of the unit.

To Watch VCR (if self-installed)

- Press VCR button on MAIN TV section of Video Selection System panel.

To Watch Rear/Bedroom TV (if equipped)

- Video selection for the rear TV is similar to front TV viewing except all selections are made with buttons in the TV2 grouping.

VCR Group Buttons

- The buttons in the VCR group are for selecting the signal input to a self-installed VCR for taping programs.
- If you wish to tape a program from cable TV press CABLE button. If the program is on the dish, press SAT, and so forth.

Further Information

For further information, see the Video Selection System operating instructions included in your InfoCase.

**FRONT TV IGNITION SWITCH
INTERLOCK**

-If Equipped

If your coach is equipped with a front overhead TV, it is plugged into a special electrical outlet with a built-in ignition switch interlock. The device allows the front overhead TV to operate only when the ignition key is in the Off or Accessory positions.



Front TV Ignition Switch Interlock
-Typical View



**TV - REMOVABLE (INTERIOR/
EXTERIOR)**

-If Equipped

**Installing TV to Exterior Sidewall
Mount**

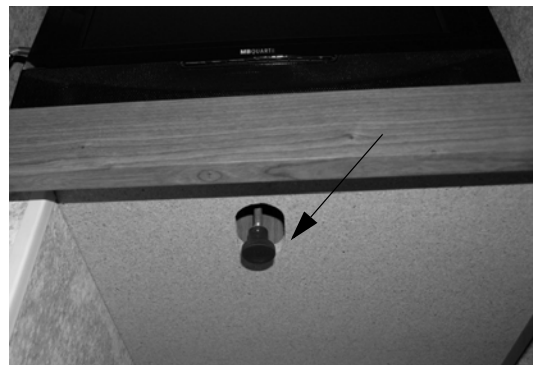

1. Press directly up on black knob (located below TV) to release the TV from the bracket mechanism.

SWING-OUT TV MOUNTS

-If Equipped

Swing-out TV's are powered by an electrical connection with a built-in ignition switch interlock. The TV will not operate in the stored position, except when the ignition key is in the Off or Accessory positions.

**TV/DVD MASTER POWER
SWITCH (12-VOLT)**

(Swing-Out TV)

-If Equipped

The TV and DVD player unit on models with the swing-out TV are powered by 12-volt coach current and have a master power input switch located on the underside of a side overhead cabinet or on a wall near the TV. The switch is labeled "12 VOLT TV" as shown.

Turn off the master power switch when not using the TV to conserve house battery charge.



- Lift TV up and away from mounting bracket.

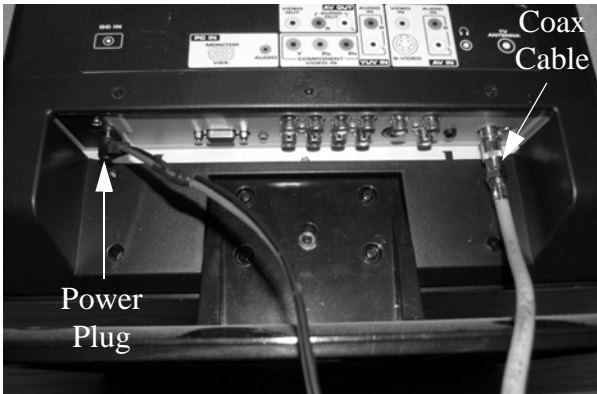

NOTE: Be sure that TV is seated firmly onto mounting bracket before releasing.

- Disconnect power plug and coax cable from back of TV.



Exterior Electrical Hook-up
(if equipped with exterior
entertainment center)



Bracket on Sidewall by
Entrance Door



Exterior Electrical Hook-up
(for units NOT equipped with
exterior entertainment center)

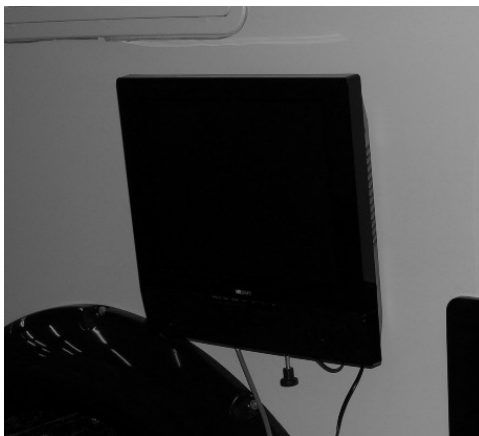

- Slide TV onto exterior sidewall mounting bracket.

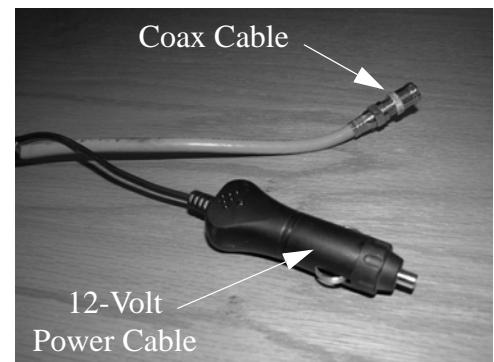

Install above two cable ends into the
exterior electrical hook-up

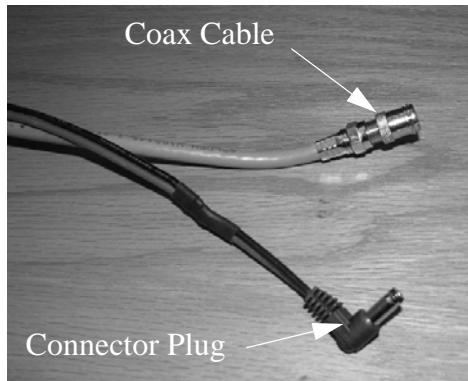

Install above two cable ends into
the back of the TV

5. Connect 12-volt power cable and one end of coax cable to exterior electrical hook-up and opposite end of coax cable and connector plug to the TV.

NOTE: These two separate accessory power cables are provided inside your InfoCase.



(Typical View)

6. Your TV is now set up for your outdoor viewing pleasure.

NOTE: The Aux Battery switch must be turned ON for the system to operate.

Reinstalling TV to Interior Mounting Bracket



1. Disconnect 12-volt power cable and coax cable from exterior electrical hook-up and opposite end of coax cable and connector plug from the TV. Re-store accessory power cables.

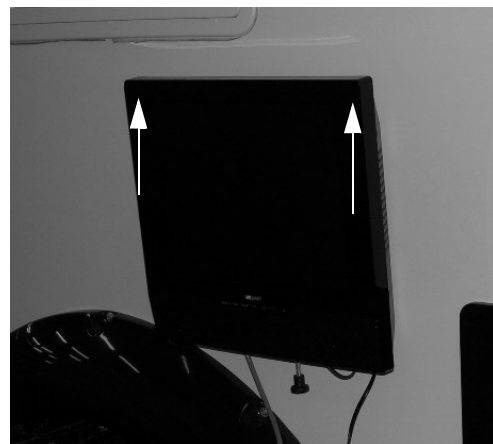

2. Lift TV straight up off of exterior sidewall mount.

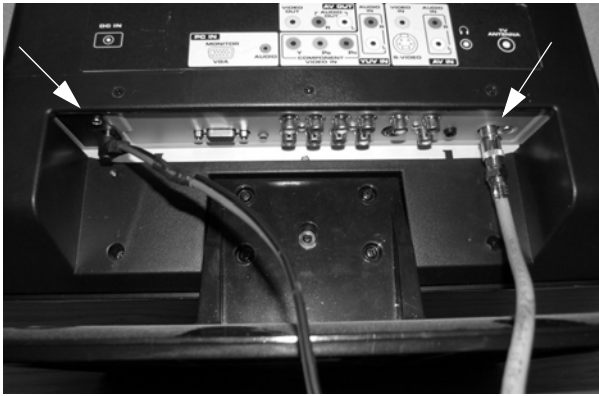

3. Reconnect interior connector plug and coax cable to back of TV.

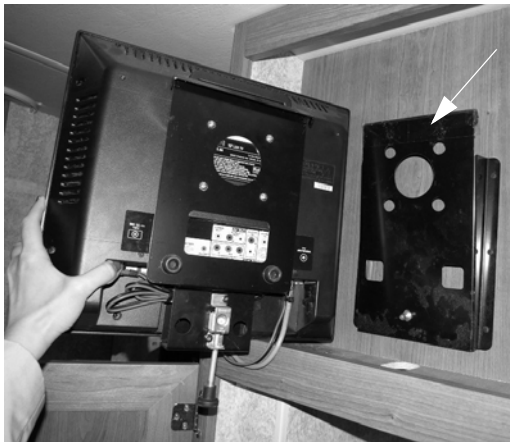

4. Reinstall TV on interior mounting bracket.



5. Press bottom half of TV straight back until it “clicks” into locked position.

NOTE: Confirm that TV is locked in place by lightly pulling on the bottom of the TV.



6. Your TV is now set up for your inside viewing pleasure.

AUDIO-VIDEO SYSTEM BASIC OPERATION

NOTE: For your convenience, we have also included a handy, tear-out version of this “A/V System Basic Operation” guide in Section 8 of your Operator’s Manual Supplement. See your InfoCase for specific operating guides for audio and video components.

DVD HOME THEATER SYSTEM –If Equipped



The available DVD home theater system operates from 120-volt AC household current only, so you must have either the shoreline connected, the generator running, or the inverter turned on (if equipped).

The TV is connected to the Home Theater System which plays through theater speakers in the lounge area of the coach.

Set TV Video Input

- Turn ON both TV and DVD player.
- Press TV/VIDEO or INPUT/SOURCE button on the remote or front of TV and select “Video 1” input on the TV.

The TV screen will display the DVD player logo when the correct input is selected.



Play DVD with Theater Sound

- Insert DVD into player. DVD will begin to load automatically. TV screen will typically show “READING” or “LOADING.”

- The DVD may load directly to the main title/menu screen or it may begin to play previews. You may be able to skip previews if desired by pressing the NEXT (CH+ / CH-) button until you see the main menu screen.

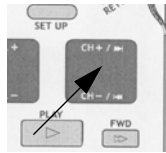

- When the main menu screen appears, use the arrow buttons on the remote to select the desired entry or press the OK or PLAY buttons on the remote (or “Play” button on DVD player) to begin playing the feature.

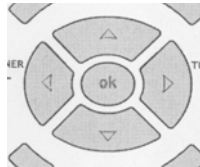

- Volume is adjusted with the DVD remote.

TV Sound Through Home Theater Speakers

When watching TV programs alone, the TV normally plays sound through its own built-in stereo speakers. If you wish to connect TV stereo sound output to the home theater speakers for a richer sound quality, follow these steps:

- Follow DVD Home Theater steps for power and TV input setup.
- Turn TV and DVD player ON.
- Press FUNCTION button on DVD player or remote to set DVD player to “AV IN.”

- Use TV Menu button to set TV audio output to “Variable Audio Output.” (See TV owner’s manual.) This routes TV stereo sound output through home theater system.
- Select TV channels and adjust volume with remote for either the TV or DVD.

DVD PLAYER

(Without Home Theater)

–If Equipped (with swing-out TV)



The DVD player is connected to the TV and plays through the TV stereo speakers or the deluxe sound rear radio speakers in the lounge area of the coach.

Provide 12V Power

The TV and DVD player operate on 12-volt DC current.

- Turn on the 12-volt master power (TV) switch (located on the video cabinet near the TV).
NOTE: When the TV is not in use, the TV master power switch should be turned off to avoid drain on the 12-volt house battery.



Set TV Sound Output

- Use the TV Menu button to set TV audio output to Variable Audio Output. (See TV owner’s manual for instructions.) This will connect TV stereo sound output to the deluxe speakers in the lounge area.
- Volume is adjusted with the TV remote or volume buttons.

Set TV Video Input

- Turn TV and DVD player ON.

- Press the SOURCE or INPUT button on the TV or TV remote to select “INPUT 1” or “AV1”.
- The TV screen will display the DVD player logo when the correct input is selected.



Play DVD

- Insert DVD into player. DVD will begin to load automatically. TV screen will typically show “READING” or “LOADING”.
- The DVD may load directly to the main title/menu screen or it may begin to play previews. You may be able to skip previews if desired by pressing the NEXT button until you see the main menu screen.

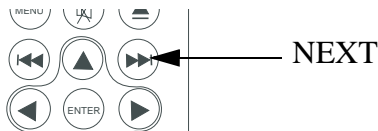

- When the main menu screen appears, use the arrow buttons on the DVD remote to select the desired entry or press the ENTER or PLAY buttons on the remote (or “Play” button on DVD player) to begin playing the feature.

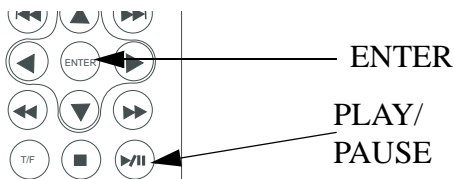

- Volume is adjusted with the DVD remote (or volume buttons on DVD player).

Further Information

For further information and operating instructions, see the manufacturer’s information included in your InfoCase.

ELECTRICAL INVERTER

300-Watt DC-to-AC –If Equipped

The inverter changes 12-volt DC automotive current into 120-volt AC household current. This allows you to operate your TV and DVD player from the house batteries when shoreline hookup

or generator power are not available.* In some models the inverter is also connected to the 120-Volt AC outlet for the bedroom TV.

The inverter is typically located in the video center cabinet or on the lower face of the galley cabinet.



300-Watt DC-AC Power Inverter

- Turn Inverter On to operate TV.
- Low Battery indicator will light if 12V house batteries are becoming drained. (Turn Off inverter to avoid total drain).
- Turn Inverter Off when not in use to avoid draining house batteries.
- The inverter will shut down when the House/Coach Battery Disconnect Switch is turned off.

**NOTE: Running high-amperage appliances like the TV and DVD on inverter power can drain the house battery rapidly unless the chassis engine is running so the alternator can charge the batteries.*

Further Information

See manufacturer’s information provided in your InfoCase for more information.

TV ANTENNA

The TV antenna on your motor home can be easily raised, rotated a full 360° and lowered from inside the vehicle by simply turning a crank or directional handle. A built-in signal amplifier designed to strengthen signals, is controlled by a power switch built into the optional video selector panel or on a wall plate assembly.

See the antenna manufacturer’s operation, care and maintenance information in your InfoCase.

 **WARNING**

Never allow the antenna to touch electrical power lines or any other electrical wires.

 **CAUTION**

To avoid equipment damage, always align directional handle to **DOWN** position before lowering. Never partially raise or lower antenna. Antenna must be raised fully up into operating position or lowered fully down into travel position.

Raising Antenna to Operating Position

Turn elevating crank clockwise in “UP” direction until some resistance to turning is noted (about 13 turns). Antenna is now in operating position.

Turn amplifier power switch “ON” to receive TV signal.



Rotating Antenna for Best Picture

Make sure antenna is in the “UP” position. Pull down on directional handle using both hands until it disengages ceiling plate and rotate for best picture and sound on TV set.



Lowering Antenna to Travel Position

Rotate antenna until pointer on directional handle aligns with pointer on ceiling plate.

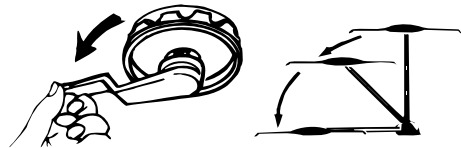

Turn elevating crank (counter-clockwise) in “DOWN” direction until resistance is noted (about 13 turns). Antenna is now locked in travel position. Turn amplifier power switch “OFF”.

TV SIGNAL AMPLIFIER

The TV signal amplifier is built into the antenna and can be turned on or off with a power switch on the video selection system in the video center cabinet above the driver and passenger seats or entertainment center cabinet.

A red indicator light will glow when the switch is on and the signal amplifier is active.



TV Signal Amplifier Switch on Video Selection System (Typical View)

Checking Amplifier Performance

The TV signals available to an RV are entirely dependent on its location in relation to the transmitter (tower). Signals may vary from strong to no usable signal at all. We recommend that the TV system be checked out in an area known to have good TV reception.

To check the antenna amplifier, raise the antenna, select a TV channel and rotate the antenna for best picture. Then turn off the amplifier power switch. If the antenna amplifier is working properly, the TV picture will now be degraded (snowy). When you turn the switch back on, the picture should again be sharp.

CABLE TV HOOK-UP

The cable television connector is located in the utility compartment.

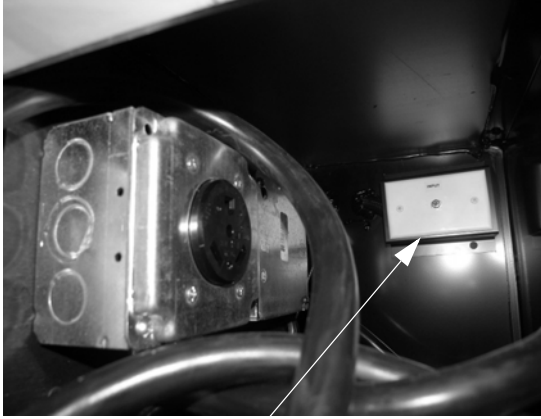

Cable TV Hook-Up
in Utility Compartment
(Typical View)

TV DIGITAL SATELLITE SYSTEM – MANUAL

–If Equipped

The Digital Satellite Television System allows you to receive TV programs directly from satellite to your coach. The programs are transmitted in digital format so the quality is equal to laser disc or CD.

We recommend that you read the satellite dish manual thoroughly to understand the system completely before attempting any setups or adjustments.

- The coach must be level before attempting to aim the antenna dish.
- There must be a clear “line of sight” to the satellite. Mountains, buildings, trees, telephone poles and other obstructions can all block the satellite signal from reaching the dish.
- Press the SAT switch on the Video Selector Panel to connect the TV to the Satellite system.

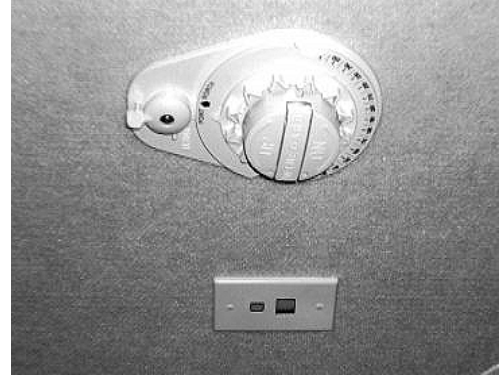

Digital Satellite Dish Control
(located on ceiling)



Further Information

See the Digital Satellite System owner’s manual in your InfoCase for operation and antenna dish aiming instructions.

EXTERIOR ENTERTAINMENT CENTER

–If Equipped

The exterior entertainment center contains a stereo radio/CD player, electrical outlets and a convenient TV hook-up for your outdoor listening or viewing pleasure.

NOTE: These electronic devices and speakers are not designed to be waterproof. Please take measures to prevent rain or other precipitation from entering the entertainment center by closing the compartment door or ensuring that an awning will prevent entrance of precipitation.

Further Information

Please read the manufacturer's operating information in your InfoCase for operation of Radio/CD player.



OUTLOOK

SECTION 9 – FURNITURE AND SOFTGOODS

SLEEPING FACILITIES

WARNING

Sleeping facilities are not intended for use while vehicle is in motion. For safety, passengers must use safety belted seating positions while vehicle is in motion.

WARNING

Do not exceed 225 lbs. maximum weight capacity. Misuse of ladder could result in death or serious injury. See Operators Manual before using ladder.

- **Maximum Capacity: 225 lbs.**
- **Do not overload.** Ladder is intended for one person.
- **Make sure you are physically capable** to safely use the ladder. Strength, flexibility and stability are required.
- **Grasp the side rails firmly** and always use both hands as you climb the ladder. Keep your body centered between the side rails. Do not over-reach.
- **To protect children,** do not leave the ladder set up and unattended.
- **Always store** the ladder in a safe and dry location when not in use. Stow properly while in transit.
- **Do not store items** on the ladder. You could damage the ladder.

FRONT OVERHEAD BUNK

–If Equipped

The overhead front bunk is located above the driver's compartment. The rear mattress section can be stacked on top of the front section for storage while traveling or when not in use.

The top of the bunk ladder must be hooked onto the brackets on the rear edge of the bunk mattress for use.

CAUTION

To avoid injury, never use the bunk ladder in any other manner or for any other purpose than described in the following instructions.

To Use the Bunk Ladder

The top of the bunk ladder must be hooked onto the brackets on the rear edge of the bunk as shown.



Attaching Bunk Ladder

Before Using Bunk Ladder

- **Inspect the ladder** to make sure it is not damaged. Never use a damaged ladder.
- **Keep the rungs of the ladder clean and dry** while in use. Do not step onto the rungs if the rungs are wet, or if your shoes are wet or carry debris that could result in a loss of footing.
- **Never ignore warning labels** or weight limits defined on your ladder. The following warning label is located on or near the ladder:

- Lift ladder horizontally
- Slide C-shaped retainer ends at top of ladder onto brackets at rear edge of mattress.



- Lower ladder to floor.
- Make sure top of ladder ladder is properly engaged onto retainer brackets and ladder is resting firmly on floor before using.



Front Overhead Bunk
Shown with bunk sections and ladder in position

Straps are provided on the mattress section to secure and store the ladder while traveling or when not in use.

SOFA/BED CONVERSION

Sofa to Bed

Lift the front edge of the sofa seat upward and pull outward from the wall while gently pushing downward on the backrest until the cushions lie flat. The bed is now ready for use.

Bed to Sofa

Push the front edge of the seat toward the wall while lifting upward on the backrest until the sofa is fully seated against the wall.

DINETTE/BED CONVERSION

–If Equipped

(Typical view – your coach may differ)

Dinette to Bed



1. Release the catch on the table leg brace and fold the leg up against the bottom of the table.



2. Remove the table from the wall support bracket by lifting the end of the table. Then lower the table to rest on the cleats attached to each dinette bench.



3. Arrange dinette cushions to cover bed area.



Bed to Dinette

1. Reattach the table onto the wall support and lower the table leg.

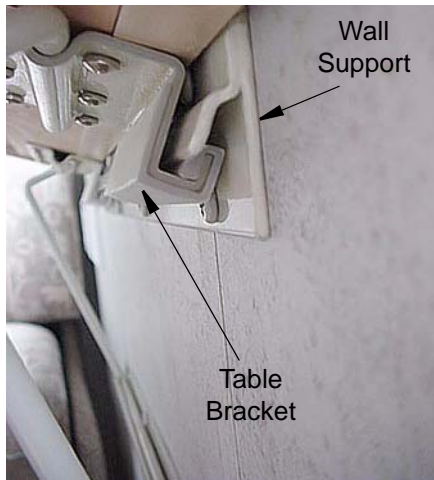

2. Make sure that the table leg is secured into the floor support bracket and the leg brace is locked.



DINETTE/BED CONVERSION

(Dream Dinette Table Mechanism)

–If Equipped

(Typical view – your coach may differ)

Dinette to Bed

1. Release the lock rod on the bottom of the table by turning the lock rod clockwise.



2. Lift the dinette cushions upward and push table straight down.



3. Lower the dinette cushions to hold the edges of the table down.



4. Arrange dinette cushions to cover bed area.



Bed to Dinette

1. Lift dinette cushions and allow table to raise back into upper position.



2. Turn the lock rod counter-clockwise back into locked position.



U-SHAPED DINETTE/BED CONVERSION

–If Equipped (Typical view – your coach may differ)

The U-Shaped Dinette can be converted into additional sleeping space when needed by lowering the dinette table and arranging the dinette cushions.

1. Release both latches on the table leg to unlock.

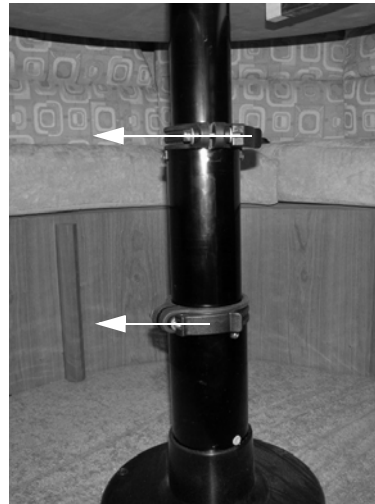

2. Lift edges of the dinette cushions up and push the dinette table straight down. Make sure the table is lowered as far as it will go so when arranging the cushions to cover the bed area, they are even with the other dinette cushions.

NOTE: You may find it easier to remove the dinette cushions completely before lowering the table, especially if just one person is converting the dinette into bed position.



3. Secure both latches on the table leg to lock in lowered position.



4. Arrange cushions to cover bed area.

NOTE: The cushions to cover the dining table section are located under the center dinette seat (lift removable panel below seat cushion to access) or you may use the back dinette seat cushion and two bolster cushions, depending on model.



Reverse steps to reassemble to dinette configuration.

SOFA AIR BED (COMFORT SOFA SLEEPER)

**–If Equipped
(Typical View)**

Sofa to Bed

1. Remove sofa back cushions.



2. Using the pull strap (attached to the back side of the sofa), pull the sofa back out and extend all the way down to the floor.

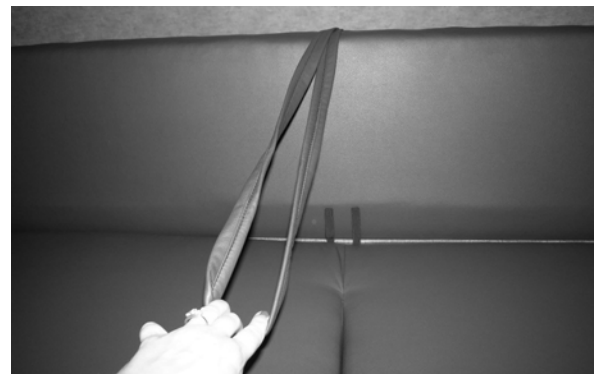



3. Rotate the lever lock (located on the bottom right-hand side of the sofa air bed) clockwise to release the locking mechanism (which is required to unfold the bottom section of the sofa air bed).

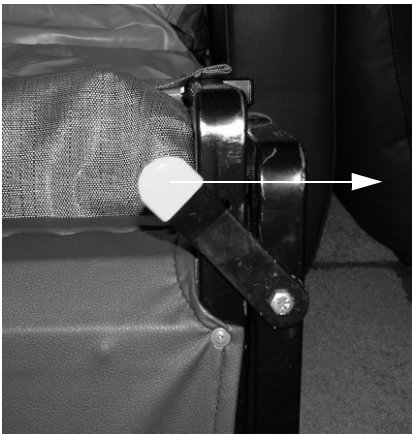

4. Once the lever lock has been released, proceed to unfold the bottom section of the sofa air bed and extend all the way down to the floor.



5. Unfold the air mattress so it is covering the sofa bed.



6. Power on the air mattress by pressing the POWER button on the air mattress hand control.

*NOTE: After hand control remains inactive for one minute, the red power indicator will turn off and the hand control reverts to sleep mode. To “wake” from sleep mode, press the power button and it will become operational.
The air bed is plugged into an AC power outlet behind the sofa.*

7. Press and hold the SET UP button on the air mattress hand control until you have reached desired firmness. When button is released, the pump will turn off.

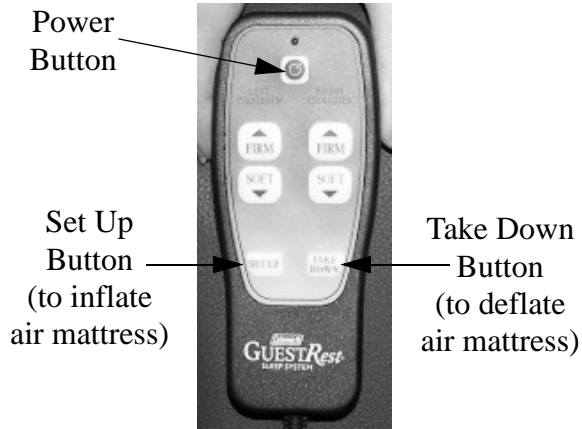

Air Mattress Hand Control
(Located on the back side of the sofa)



Adjusting the Left and Right Chambers for Individual Firmness

Left Chamber Right Chamber



- To increase the firmness of the air mattress, press and hold the FIRM button (on the preferred chamber located on the hand control). When the button is released, the pump will turn off.
- To decrease the firmness of the air mattress, press and hold the SOFT button (on the preferred chamber located on the hand control). The internal valve will open and release air. When the button is released, the valve will close and remain airtight.

Bed to Sofa

1. Press and hold the TAKE DOWN button on the air mattress hand control until the air mattress is completely deflated. When button is released, the pump will turn off.



2. Fold in the bottom section of the air mattress.

NOTE: Before bringing the bottom section of the sofa air bed up, the edges on each side of the mattress must be folded IN approximately 6 inches to avoid pinching and obstruction of the mattress.



3. Lift up the bottom section of the sofa air bed and bring all the way up.



Further Information

For further operating instructions, cautions, and maintenance care, see the manufacturer's user guide included in the air mattress carrying bag.



4. Rotate the lever lock counter-clockwise, securing back to the locked position.

PLEATED BLINDS

Your coach may feature pleated window blinds for nighttime privacy and daytime room darkening purposes.

They are raised or lowered by grasping the bottom edge of the blind and moving it up or down by hand.

A constant-tension cord system holds them at the desired level without slipping.

Tension Adjustment

The tension of the pleated blinds can be adjusted if they become loose and will not stay up when raised, or they are too tight and are difficult to raise and lower.

The tension cords are attached to spools at the lower corners of the blinds as shown in the following photo.



5. Grasp the pull strap and proceed to bring sofa all the way up. Once the sofa is back in original position, replace the sofa back cushions.



To Tighten Tension

Wrap the tension cords around the mounting spools, one turn at a time, at both ends of the shade. Check tension by raising and lowering a few times. Repeat as necessary to obtain the desired tension. Do not over-tighten.

To loosen tension

Unwrap the guide cords from the spools, one turn at a time, until desired tension is achieved.

Preserving Shape

The pleated blinds are made using high quality materials that are designed and woven to retain their shape throughout their useful life. They may lose their crisp shape, however, if left in a lowered position for an extended period of time without being raised periodically. If this happens, the pleats can be restored using this simple method.

- With the blind fully lowered, dampen the entire area of the pleats with a good quality laundry starch.
- Raise the blind fully while still damp and let it remain in the raised position for about 24 hours.
- Reapply starch periodically (every few months) as needed.

WOOD FURNITURE AND CABINETRY

–If Equipped

People are drawn to the natural beauty of wood. At Winnebago Industries®, our craftsmen work with the art found in each piece of wood to create cabinets of superior quality, backed by the Winnebago Industries warranty.

- Oak is a strong, open-grained hardwood that ranges in color from white to pink and reddish tones. Streaks of green, yellow, and even black may appear due to mineral deposits. Oak may also contain wormholes and wild, varying grain patterns. This distinct graining is considered a desirable quality and has made oak one of the most popular woods used for cabinetry.

- Maple is a close-grained hardwood that is predominately white to creamy-white in color, with occasional reddish-brown tones. While maple typically features uniform graining as compared to other wood species, characteristic markings may include fine brown lines, wavy or curly graining, bird's eye dots and mineral streaks. These traits are natural and serve to enhance maple's natural beauty.
- Cherry is characterized by its red undertones, but may vary in color from white to a deep, rich brown. Cherry is a close-grained wood with fairly uniform texture, revealing pin knots and curly graining. All wood will age with time and the finish will darken. This is especially true for cherry. This is a sought-after quality in cherry cabinetry, and those who select it expect this evolution.

No matter which species you choose for your new Winnebago Industries motorhome cabinetry, please keep in mind that no two pieces of wood are exactly the same.

Stains are likely to exaggerate the difference between open and closed grains and other markings in wood. Grain variation and color change should be expected. As hardwood ages, it will darken when exposed to different types of light. Color differences or changes in wood can also be caused by exposure to harsh chemicals, extreme heat, or other contributing external conditions.

Any color change that occurs in both the finish and the wood is considered part of the natural aging process and is not to be considered defect or damage.

Additionally, wood species exhibit other defining characteristics, such as mineral deposits/streaks, knots, sap runs, pin holes, and wormholes. These markings make the wood unique and contribute to its enduring beauty.

Therefore, since wood is a product of nature and will have certain natural characteristics and variances, they are not covered under the warranty.

OUTLOOK

SECTION 10 – SLIDEOUT ROOMS AND LEVELING

SLIDEOUT ROOM TRAVEL LOCK

-If Equipped

Some models are equipped with an expandable prop-lock rod device to restrict movement of the slideout room while the vehicle is in motion.

The Lock Rod **must be released before extending the room** or damage to the coach will result.

NOTICE

Release and remove Slideout Prop-Lock Rod before attempting to extend slideout room. Damage to the vehicle will result if this is not done. Position and secure Prop-Lock before driving vehicle. See following instructions.

To Release Lock Rod:

- Rotate the body of the cylinder to loosen and remove lock rod.



Place T-shaped rod end against back side of slideout frame

Rotate cylinder body to loosen or tighten ends

Place flat plate end against coach sidewall

Slideout Room Prop-Lock Rod

Typical view of forward end of retracted slideout room directly behind driver seat. Your model may differ in appearance.

To Secure Lock Rod

- Place the flat plate end of the lock rod against the outer wall of the coach about 6" down from the top edge of the forward end of the retracted slideout room (behind the driver seat in most cases).
- Swing the T-shaped end of the rod into place against the back side of slideout room flange (frame) as shown.
- Rotate the cylinder body to tighten the lock rod snugly. During vehicle stops, check and retighten as necessary.

Master Keylock

A master keylock switch is located near the power switch for the front slideout room. This keylock must be turned on to provide power to the slideout control switches.



Slideout Room Keylock

The key to turn the master keylock “off” is attached to the lock rod. This is to remind you that the rod is removed prior to turning the switch.



SLIDEOUT ROOM OPERATION
– ELECTRIC

 **WARNING**

Your motor home may have more than one slideout room. Understand which switch operates which slideout room prior to operation. Make sure all slideout rooms are clear of people who could be harmed or obstacles that could cause damage prior to operating any slideout rooms. Failure to observe can result in death or serious injury.

Slideout rooms provide a spacious living area at the push of a button.

Front slideout room switches (if equipped) are located either on the dash, near the main entry door, or near the Systems Monitor Panel. Location varies by model and floorplan.

Rear slideout switches (if equipped) are located on a wall in the rear of the coach in or near the slide room. Location varies by model and floorplan.



Slideout Switches

(Your coach may have one or more of these switches depending on model, options, and available equipment)
-Typical View

NOTE: Never drive the vehicle with a slideout room extended!

The slideout room system uses 12-volt DC motorized mechanisms with an electronic control system to provide smooth operation and positive weather seal.

NOTE: We recommend that you KEEP THE ENGINE RUNNING WHILE EXTENDING OR RETRACTING

SLIDEOUT ROOMS so the engine alternator can provide maximum power for proper operation of the slideout mechanisms.

WARNING

Keep all persons clear of the slideout room and moving parts while extending or retracting. Do not occupy the slideout room while it is being extended or retracted. Failure to observe can result in death or serious injury.

To Extend Slideout Room

Before Extending!

- Level the coach and set the Parking Brake.
- Release the travel lock or latch (if equipped) inside the coach. *See information at beginning of this section (if equipped).*
- Make sure exterior compartment doors are closed so that they will not interfere with slideout operation.
- Check inside and outside the vehicle to make sure that there are no people who could be harmed or obstacles that could cause damage due to room extension.
- If the slideout room has a couch or other furniture, make sure no people or pets are seated on them until the room has been fully extended.

NOTICE

Release slideout room travel latch before attempting to extend slideout room.
Secure travel latch before driving vehicle.

Extend Procedure:

See “Before Extending!” before proceeding.

- Start the engine so the alternator can provide maximum power for proper operation of slideout mechanisms.

- Insert the Safety Lock key and turn to activate slideout room control switch.
- Press the Slideout Room “EXTEND/OUT” switch and hold until the room is fully extended, then release the switch.
- To stop extending the room during operation, release the button.
- Deactivate the slideout switch with the Safety Lock key.

To Retract Slideout Room

Before Retracting!

- Be sure the coach is level and the Parking Brake is set.
- Check inside and outside the vehicle to make sure that there are no people who could be harmed or obstacles that could cause damage due to room retraction.
- If the slideout room has a couch or other furniture, make sure no people or pets are seated on them until the room has been fully retracted.
- Remove all items from the coach living room floor and close cabinet doors and drawers. Be sure there are no items at the end of the bed, behind the driver seat, or protruding from compartments, which could be crushed or cause damage to floor covering or cabinets when the room is retracted.

NOTICE

Because the slideout roof is drawn into the interior of the coach when retracted, be sure there is no debris, such as excessive dirt, tree seeds, twigs, leaves, etc. on the roof before retracting.

If it has rained recently before you retract the slideout room, we recommend using the hydraulic leveling system (if equipped) to lean the coach and drain off any excess water possibly remaining on the roof before retracting. Lean the coach slightly to the left (driver’s side) as shown

SECTION 10 – SLIDEOUT ROOMS AND LEVELING

by raising both right side jacks to let excess water flow away from the rooftop weather seal and toward the outside of the slideout roof. Retract the slideout slowly, starting and stopping to allow water to drain off room cover.

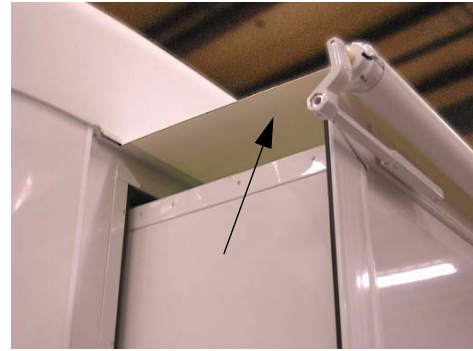
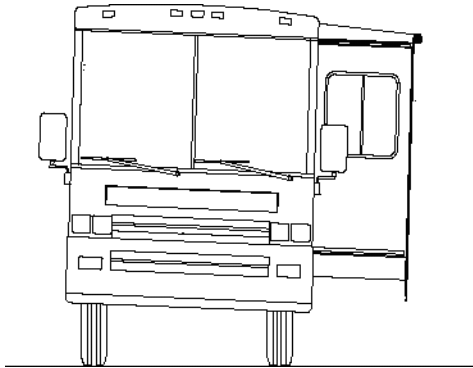

Slideout Cover-Awning
-Typical View

Retract Procedure:

See *“Before Retracting!”* before proceeding.

- Start the engine so the alternator can provide maximum power for proper operation of slideout mechanisms.
- Insert the Safety Lock key and turn to activate slideout room control switch.
- Press the Slideout Room “RETRACT/IN” switch and hold until the room is fully retracted, then release the switch.
- To stop retracting the room during operation, release the button.
- After the room is retracted, deactivate the slideout switch with the Safety Lock key, then refasten the travel lock or latch inside the coach (if equipped).

SLIDEOUT ROOM – EXTREME WEATHER PRECAUTION

Certain extreme weather conditions, such as heavy rains, heavy snow, and high winds, or any combination of these, could cause damage to the slideout room cover-awning (if equipped) or reduce effectiveness of the slideout room weather seals.

Also, freezing rain and snow can prevent the slideout cover-awning (if equipped) from closing and may cause damage to the cover-awning, slideout room, weather seals, and mechanisms.

To avoid potential damage, we recommend retracting your slideout room during extreme weather conditions.

SLIDEOUT ROOM TROUBLESHOOTING – ELECTRIC

Battery Voltage or Circuit Breaker Problems

If the slideout room will not work:

- Turn the Chassis Battery Disconnect Switch OFF and then ON again. This will (in many cases) reconnect power to the slideout system.
- The chassis battery may be low on charge. Press and hold the Battery Boost Switch on the dash while pressing the slideout control switch. This momentarily connects the house batteries to assist in slideout room operation.
- The circuit breaker may be tripped. The circuit breaker, labeled “Slideout Power” is located on a panel on an interior wall of the passenger side storage compartment just behind or ahead of the entrance door.

Problems Retracting the Room

- Set the Park Brake if the Engage Park Brake light flashes while pressing the Retract (IN) button.

Light will flash if
park brake not set

Light will flash fault
code if system
malfunctions



Low Voltage
Indicator

Slideout Touchpad
(Located near monitor panel)
-Typical View

If an error is detected on your slide system, the LED light on the control panel will blink an error code. If an error code appears, see the manufacturer's user guide in your InfoCase to determine the problem. The error code must be cleared prior to operating the room. To clear the error and reset the system:

- If none of the “Battery Voltage or Circuit Breaker Problems” troubleshooting recommendations reset the system, remove the touchpad from the monitor panel (a screwdriver will be needed) and press and hold the RESET button (“Set Stops/Clear Fault”) located on the back of the touchpad for 5 seconds. The slideout is now ready to be retracted. Press IN on the touchpad to retract the room.
- Reinstall touchpad to the wall.
- Take your RV to an authorized service center for repair.

Before operating the room after an error has been detected, check for obvious faults such as obstructions prior to trying to operate the room again. If the error code appears again, the room will need to be retracted using either the manual retraction method or the fully manual method.

Both methods listed below are intended as a means to retract the room to prepare the coach for travel to the nearest authorized service center.

Manual Mode

Manual Mode lets you individually move the two room arms by pressing the IN and OUT buttons on the touchpad. This mode can be used only if there is not a motor failure or full electrical system failure. To override the encoder and enter the Manual Mode, press and hold the RESET button (“Set Stops/Clear Fault”) located on the back of the touchpad until the two LEDs begin to flash.

While in the Manual Mode, each of the two room slide arms are activated by pressing and holding the IN and OUT buttons. The “OUT” button will retract the front arm. The “IN” button will retract the back arm. Both IN and OUT buttons may be held down at the same time to simultaneously activate both arms to retract the room. If one side of the room gets ahead of the other, release that button until the other arm catches up. The current limiting feature of the control still functions in the Manual Mode so each side can be fully retracted until it stops.

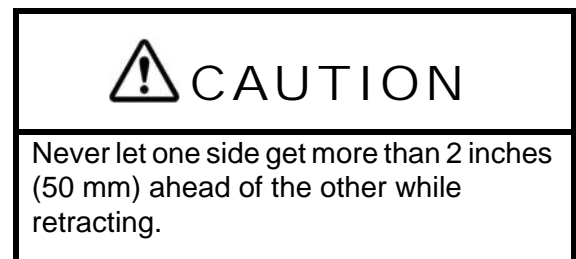

Once the room has been retracted, the control will return to the automatic mode after 60 seconds.

In the event of a total system failure where Manual Mode cannot be used, two crank handles may be used to retract or extend the room. See *Slideout Emergency Retraction - Electric* elsewhere in this section.

Problems Extending the Room

- Set the Park Brake if the Engage Park Brake light flashes while pressing the Extend (OUT) button.

Light will flash if
park brake not set

Light will flash fault
code if system
malfunctions



Low Voltage
Indicator

If an error is detected on your slide system, the LED light on the control panel will blink an error code. If an error code appears, see the manufacturer's user guide in your InfoCase to determine the problem. The error code must be cleared prior to operating the room. To clear the error, perform the following steps (one at a time) to reset the system:

- If none of the “Battery Voltage or Circuit Breaker Problems” troubleshooting recommendations reset the system, remove the touchpad from the monitor panel (a screwdriver will be needed) and press and hold the RESET button (“Set Stops/Clear Fault”) located on the back of the touchpad for 5 seconds. The slideout is now ready to be extended. Press OUT on the touchpad to extend the room.
- If touchpad was removed, reinstall to the wall.
- Take your RV to an authorized service center for repair.

Further Information

See the slideout room operating guide included in your InfoCase for further instructions and troubleshooting information.

SLIDEOUT EMERGENCY RETRACTION – ELECTRIC (Front Slideout Room)

Crank-In Mode

If the room mechanism is malfunctioning and will not retract using the buttons, you will need to manually crank the room in to the travel position. *(The room can also be cranked out into the extended position using this method if necessary.)*

The slideout crank tools are stored in clips on the wall of an exterior storage compartment.

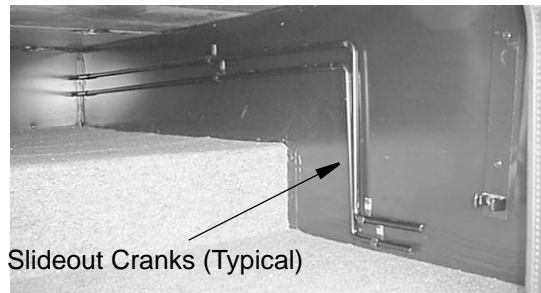

Slideout Cranks (Typical)

The crank sockets are located behind covers on the lower ends of the room on the outside of the coach. Your coach may have one of the two types of covers shown.

Type A (Twin Arm) - Covers on lower face of room (Photo 1A)

Pry out the snap-in screw cover (Photo 2A) and remove the screw to take off the cover plate. (The crank socket is shown in Photo 3.)





Type B (Single Arm) - Cover mounted beneath face of slideout room

Remove the four bolts that fasten the cover to the arm – two on each side. (The crank socket is shown in Photo 3.)

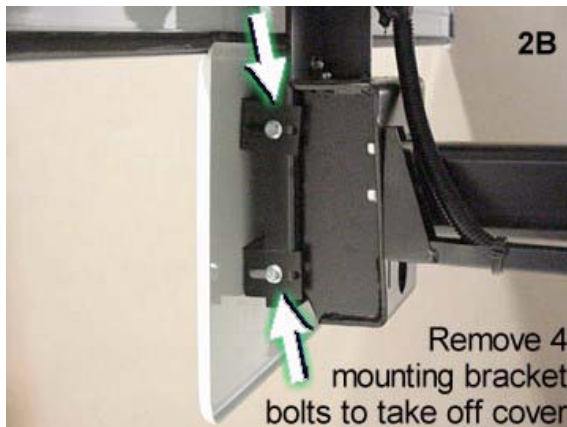

Crank-In Procedure

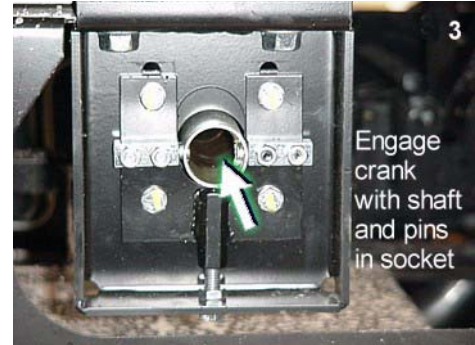

- Insert the crank handle into the gear shaft socket, aligning the notches in the crank handle with the pins inside the socket as indicated. If twin arm mechanism, insert the second crank at the other end of the room. *(It may be necessary to move the crank handle from side to side slightly to fit onto the shaft.)*
- Each crank will only move the arm that it is inserted into. For twin arm mechanisms, you will need to alternate between crank handles at each end to move the room in or out.
- The most effective way for one person to retract a twin arm room is to “walk” the room in – that is, to crank one side until it is just slightly ahead of the other, then crank the opposite side in until it is slightly ahead of the previous one. Crank both sides alternately and equally to avoid wedging the room. *(see following Notice).*
If help is available, a second person cranking on the other handle simultaneously will greatly speed up the process.

NOTICE

Never crank one side more than 2 inches (50 mm) ahead of the other while retracting or extending.

- Crank the room in until it is just “snugged up”. Do not overcrank or you could damage the crank or gear assembly.

SECTION 10 – SLIDEOUT ROOMS AND LEVELING

OUTLOOK

- Fasten slideout room travel latching device (if equipped) inside the coach before driving the vehicle.
- See your dealer for service of the slideout mechanism before using again.

Further Information

See the Slideout Room operating guide included in your InfoCase for further instructions and troubleshooting information.

SLIDEOUT EMERGENCY RETRACTION - BEDROOM

-If Equipped

Crank-In Procedure

- Locate the tools in the right front side storage compartment - a ratchet wrench, a hex-end shaft, and an extension shaft. (The ratchet wrench may be packaged in the InfoCase).



-Typical View
(if chassis-supplied)

- Locate the small, round access hole in the bed base at the foot of the bed.



- Attach the shaft extension to hex-end shaft and place the ratchet wrench onto the hex end shaft, then insert into the hole in the bed base as shown.



- The slotted end of the tool must engage with the pin in the endshaft on the slideout gear assembly. See arrow in close-up detail.



- Crank the ratchet wrench clockwise to retract the room. The tool will extend nearly a foot out of the bed base at first, but will be drawn into the bed base as the room is retracted. This is a slow process that will take some time and quite a few turns of the wrench.
- As the room retracts, the bed base will move away from the gear endshaft, which will eventually cause the tool to lose contact with the shaft. When this happens, you must raise the bed, remove the access cover to access the gear endshaft, and continue using the wrench and hex shaft only as shown.



GENERAL SLIDEOUT CARE

- Wipe outer seals occasionally with talc or 303 brand protectant for smooth quiet operation.
- Clean the floors inside before retracting the room to avoid vinyl flooring scratches or carpet pile snags.
- See your authorized dealer for regular maintenance and service of the slideout mechanism.

LEVELING SYSTEM

–If Equipped

The hydraulic leveling system makes selecting a parking site easier and faster by reducing the effect of uneven ground.

Hydraulic jacks raise the affected low corners of the coach to make leveling “set up” faster and easier for you.

The leveling system control panel is located on the dash.



Leveling System Control Panel
(Located on dash)
-Typical View

See the Leveling System Operator Manual in your InfoCase for complete operating instructions. It also contains additional precautions, technical information, and instructions for manual operation if a system failure occurs.

NOTE: When parking at an uneven site, always park the front of the motor home to the downhill side. This allows you to level by raising the front end rather than the rear. Since only the rear wheels are locked while in PARK, raising either one or both of the rear wheels off the ground could allow the vehicle to roll off the jacks.



“Jacks Down” Light
(Located on dash)
-Typical View



WARNING

- Keep all people clear of the coach while the leveling system is operating.
- When extending the rear stabilizers, do not lift the wheels beyond ground contact. This makes it possible for the vehicle to roll unexpectedly forward (or backward) off the jacks. This could cause severe injury or death.
- Do not use the levelers on icy or slick surfaces on which the foot pads may slip.
- Do not use leveling jacks to support the vehicle for service or tire changing.
- Do not use the leveler as an emergency brake. They are not designed for any type of vehicle braking purpose.
- Never check for hydraulic fluid leaks using your hands and/or any other body part. The leaking fluid is under pressure and is capable of cutting and penetrating your skin, resulting in severe injury.

Jacks Down Light

The “Jacks Down” reminder is intended to warn you to retract your leveling jacks before moving the vehicle. The light will come on briefly and a chime will sound when the ignition key is turned to the On or Run positions if the jacks are down.

NOTICE

- Do not try to drive vehicle unless “TRAVEL” light is glowing with ignition switch on.
- Do not try to drive the vehicle until the air suspension system has built up sufficient pressure if you have used the coach leveling system or have used the DUMP button to manually exhaust the air suspension system.
- Do not rely only upon the warning lights to indicate when jacks are up. It is the owner’s responsibility to check that all jacks are up before moving the coach.

NOTE: If the leveling jacks should fail to retract, see the MANUAL JACK RETRACTION section of the Leveling System Operator’s Manual included in your InfoCase.

In The Event Of Accidental Jack Extension

1. Bring the vehicle to a safe and complete stop as soon as possible.
2. Turn the leveling systems power switch on and press the “Auto Store” switch.
3. Visually inspect the vehicle undercarriage for any problems.

4. See the Leveling System Operator's Manual supplied in your InfoCase for troubleshooting instructions or operating the leveling system if jacks fail to retract or any other functions fail.

CHECKING HYDRAULIC OIL LEVEL

See the Leveling System Operator's Manual in your InfoCase for complete maintenance instructions and information.

All maintenance should be done as part of the normal servicing of the coach.

The hydraulic oil level should be checked when the vehicle is first purchased, and then twice a year - or more often if an oil leak develops in the system.

The hydraulic pump is located inside a passenger side rear compartment or a driver side front compartment, depending on model. In some cases, there is a removable access panel inside the compartment that must be removed to access the pump.

Jacks and Slideout Positions

To get an accurate indication of oil level:

- Leveling Jacks must be UP
- Slideout Rooms must be IN

Checking Dipstick

The hydraulic oil level is checked with a dipstick built into the breather/filler cap on top of the oil reservoir, which is part of the hydraulic pump/manifold assembly.

NOTE: Always clean away any dirt and debris from the top of the reservoir before removing the breather cap to avoid entry of debris and contamination of hydraulic oil in the reservoir, which could lead to pump failure or other problems.

The oil level should be between the two marks on the breather cap dipstick shown in the following photo.

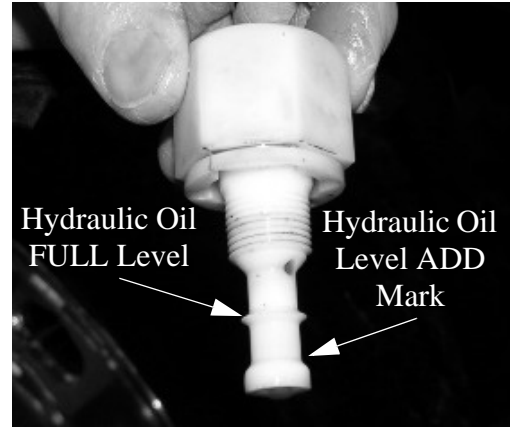

Hydraulic Oil Breather Cap/Dipstick
-Typical View

NOTE: Overfilling the hydraulic reservoir can cause leakage of oil through the breather cap.

Hydraulic Fluid Recommendation

HWH[®] specialty hydraulic fluid or Dexron[®] III automatic transmission fluid is recommended for use in this system.

DO NOT USE brake fluid or hydraulic jack oil, which can damage the seals and cause leaks.

SECTION 11 – MAINTENANCE AND STORAGE

SEALANTS – INSPECTION AND GENERAL INFORMATION

Water is a recreational vehicle's worst enemy when it is allowed to enter where it is not intended. Sealants perform a very important function and should be inspected closely and maintained regularly. Winnebago Industries® utilizes many different types of sealants. Refer to the "Sealants Call-Out Sheet" provided in your InfoCase for further information.

Sealants, in general, do not have "set" lifetimes. Varying environmental factors affect the pliability and adhesiveness of sealants. You or your dealer must:

- Inspect all sealants, a minimum of every six months.
- Inspect the moldings, windows, clearance lights, exterior compartment doors, and all their attachments.
- Also, inspect weather seals around entrance door, etc., and if necessary, have a dealer replace them immediately.
- Check for cracks, voids, gaps, breaks, adhesion, and any sign of physical deterioration.

NOTE: Proper sealant inspection includes not just visual observation but running a finger along sealant seams to verify proper adhesion to the surface. Any loosened areas must be replaced.

- Have the sealant replaced if you notice any of the above. Your local Winnebago Industries dealer has the correct and necessary parts and experience to help you maintain your sealants. See "Sealants Call-Out Sheet" provided in your InfoCase.
- Always use the same type sealant that was removed.
- Immediately have dealership check moldings, windows, and exterior attachments for leak source if you notice water inside of unit.

NOTICE

Sealants must be inspected every 6 months and replaced if necessary.

ROOF



WARNING

Stay off roof. Roof surface may be slippery. Falling could result in death or serious injury.

The roof is made of Thermo-Panel materials like the walls and floor. It will support the weight of an average adult for periodic maintenance or repair of the roof or roof mounted components.

Walking or working on the roof should be left to qualified service personnel using proper safety equipment in a safe environment. You should only walk or work on the roof if you are qualified and have created a safe environment.

For your safety, it is not recommended that you store or carry items on the roof.

Always have damage to the roof area repaired immediately. Damaged or detached sealant around the vents, air conditioner, body-to-roof seams, etc., should also receive immediate attention. Delaying these repairs may allow water leakage and result in damage to interior ceiling and body panels, upholstery, etc., which is not covered by the limited warranty (see Introduction section).

UNDERCARRIAGE

Buildup of mud and dirt under the body of the coach can cause damaging rust or corrosion on steel or aluminum parts and can add needless

weight to the vehicle. This, in effect, reduces the amount of cargo you can carry and remain within GVWR and GAWR limits.

Corrosive materials, such as those used for ice and snow removal and dust control, can also accumulate on the underside of a vehicle. These materials should be removed by flushing the undercarriage regularly with water, especially horizontal surfaces, cavities, and other areas where mud and other deposits may collect.

EXTERIOR AUTOMOTIVE PAINT FINISH

–If Equipped

The body of your coach is fully or partially finished with the highest quality automotive paint and clearcoat. Follow these precautions to keep the finish on your coach looking its best and preserve maximum gloss and durability.

Parking

- **Avoid parking under trees** – When this happens you should rinse the bird droppings and tree sap off as soon as possible. Tree sap is a form of sugar and will dissolve after a couple of rinses. Bird droppings can eat into a painted surface if left unattended and need removed as soon as possible. Lukewarm soapy water can help speed up the cleaning process.
- **Avoid parking near salt spray** – When this happens you need to rinse off the salt mineral residue to minimize the corrosiveness of the salt.
- **Avoid parking near factories with heavy smoke or industrial fallout** – Industrial fallout can eat into your coaches finish when dew or rain mixes with it to create nitric or sulfuric acid that gets magnified by the intensity of the sun. As the water evaporates the acid becomes more powerful and attacks the painted surface.
Rinsing and washing the surface helps remove the fallout and neutralize the acid. After the

initial 60-day cure stage, a coat of wax or polish can help protect the surface from these types of contaminants.

- **Do not scrape ice or snow from the painted surface.** Brush off gently with a soft-bristled ‘snow brush’ – avoid being forceful with the brush.
If brush scratches show after the motorhome thaws out, it may be possible to remove them by hand waxing with a silicone-free liquid wax.

Driving

- Avoid driving on gravel roads.
- Rinse off bugs and bird droppings with water daily.
- Antifreeze, fuel or windshield/window solutions spilled on the painted surface should be rinsed off immediately with water and allowed to air dry. Wiping dry with a towel may create fine scratches due to the solvent nature of these types of fluids.
- Fuel cannot be diluted and dissipated with water. It must be removed with a mineral spirit type cleaner (such as *SEAFOAM Bugs-B-Gone* or equivalent) or a silicone-free spray wax and microfiber cloth to remove the stain left by fuels.

NOTE: When driving in wintry conditions the road surface may be covered with heavy salts or small rocks to improve road traction. These types of road conditions can cause undue surface damage to your RV. Please refrain from driving in these conditions

Washing

- Commercial vehicle wash facilities should be strictly avoided! They will scratch your RV!
This is because truck style wash centers have high-pressure wands that emit higher than necessary water pressures and the brushes are very aggressive. Most truck wash brushes are made from a heavy plastic for durability and are under heavy pressure. They are designed

to clean heavy road films on semi trailers and are often dirty. They are not designed for custom painted RV's and they will scratch the clearcoat finish. Many times these scratches can penetrate the clearcoat finish causing delamination and/or other paint related issues that are not covered under warranty.

- Wash your RV with cool or lukewarm water using a mild soap– such as a baby shampoo– that does not contain bleach solution. Most auto stores offer car wash detailing soaps that are similar and do not have bleach in the formulation (*such as Meguiars #62*).
- Never use a bristled brush or broom to wash the painted surface. This will cause scratches in the finish. Use a clean lamb's wool mitt, sponge or microfiber mitt (or mop) to wash your unit.
- Be sure your cloth or applicator is clean. A dirty applicator can scratch your RV.

Washing Procedure

- Rinse area to be washed with cold water to remove surface residue. Make sure you are not in direct sunlight.
- With area to be washed still wet from the rinse, use the recommended soapy mixture to clean the area. Use care to make sure that a clean lambs wool mitt, sponge or Microfiber mitt or mop is used to apply soapy water.
- Rinse washed area before soap evaporates.
- Dry the rinsed area before the water evaporates.

NOTE: Avoid aiming water flow from a hose or spray from high pressure washing equipment into any appliance intake because damage or difficulty in operating appliances may occur.

- After washing the coach, carefully inspect sealant around window frames and vents and any other joints that may have loosened or separated. See “Sealants” at the beginning of this section for details.

Bug Removal

- Rinse the loose debris off with water and allow the remaining residues to soak and soften. Use soap and water to wash the residue, then rinse. (You may wish to repeat and leave soap on longer than normal to help with softening hardened residue.)
- For more stubborn areas use an ammonia based glass cleaner followed by a warm soapy water wash and a rinse.
- Remember to use micro-fiber towels during this process to help avoid scratches.
- If this does not work, as a last resort, use a bug removal product (*like SEAFOAM Bugs-B-Gone or equivalent*) in a shady area and follow the directions on label.

Polishing and/or Waxing

NOTE: When your coach is new or has been repainted for any reason, no polish or wax should be applied to the finish until after a 60-day cure cycle at temperatures higher than 60 degrees for 60 days. Failure to observe this precaution could void your paint warranty.

- We recommend a silicone-free polish (*such as Meguiars M8132 Hand Polish or Machine Polish*) with an orbital machine and terry cloth applicator.
- Liquid waxes are easier to apply and bring to a gloss with fewer residues.
- Avoid paste waxes. They sometimes have fillers and additives that give a very short term result. Stay away from silicones in polishes and soaps.
- Buffing Compounds remove some of the mil film of the clearcoat, so we recommend that only professionals or very experienced users apply this type of product.

Inspection

A motorhome exterior is subjected to many physical forces and environmental conditions. While the coach is parked, it is exposed to climate and weather extremes and other environmental conditions. While in operation, it

is subjected to various twisting and flexing forces caused by routine cornering and turning, and by uneven road surfaces, such as bumps, potholes, railroad tracks and parking lot entrances.

Inspect the exterior fiberglass shell periodically for cracks which may represent a threat to the integrity of the fiberglass.

Minute cracks in the surface, commonly called "spider cracks" or "hairline cracks" caused by normal flexing of the fiberglass exterior are normal and typically pose no threat to the integrity of the vehicle other than appearance.

However, if a crack has opened up and the weave of the cloth is visible, this does represent a threat to the integrity of the fiberglass and must be repaired or covered as quickly as possible to avoid penetration by moisture, especially in freezing climates.

If the fiberglass has been damaged and contains cracks, tears or holes, use plastic sheeting and duct tape, if necessary, to prevent moisture from damaging the sidewall material or the interior of the coach.

CARE OF APPLIQUES AND DECALS

The pressure-sensitive appliques and decals on your coach require very little maintenance. They should be treated like any painted surface on your vehicle.

Here are a few helpful hints on caring for decals:

- Wash appliques and decals with plain soap and water or any retail car wash soap. Always rinse thoroughly.
- **High pressure water spray may loosen or damage appliques and decals.**
- Test any cleaning solution on a small section of appliques or decal before using.
- Never use aromatic solvents such as acetone, MEK, toluene, xylene, lacquer thinner, etc., on appliques or decals. Any solvent including alcohol may soften or smear colors.

- Fuel or antifreeze spilled on appliques or decals should be rinsed off immediately with water.

PLASTIC PARTS – CLEANING

Many parts in your motorhome, such as the dash, exterior light lenses, and certain exterior body panels are made of high-impact plastic materials that can be damaged by wiping with solvents or improper cleaning products.

Always try cleaning plastic parts with the mildest cleaners first and work your way up to stronger cleaning products. Use the following cautionary lists as a guide when selecting cleaning products to use on plastic parts.

NOTICE

Do not use citrus-based cleaners on polycarbonate finishes. Citric compounds will damage the high-gloss surface, causing it to appear dull or "flat". Always test a cleaning product on a hidden area to be sure it will not cause damage to the appearance of the part.

Here is a list of mild cleaners that **may be used safely**:

- Car washing soap and water
- Glass cleaners *without ammonia*
- Mineral oil
- Multipurpose cleaners (such as Fantastik[®], Formula 409[®], etc.)

The following products, compounds, or solvents must be **wiped off immediately** to avoid damage:

- Ammonia
- Brake fluid
- Bathroom basin, tub, and tile cleaners
- Chlorine
- Ethyl alcohol
- Isopropyl (rubbing) alcohol

- Kerosene or gasoline
- Naphthalene
- Pine-type household cleaners

Do not use cleaners containing the following products, compounds, or solvents. These products **will damage** the finish.

- Acetic acid
- Acetone (nail polish remover)
- Aromatic solvents (lacquer thinners)
- Benzene
- Butyl alcohol

EXTERIOR LIGHTS

Most Winnebago Industries® vehicles have polycarbonate lenses on exterior lamps, which are very sensitive to a variety of chemical solvents and cleaners.

Use only soap and water to clean exterior lamp lenses, especially headlights.

- Contact with certain chemicals can cause etching, “crazing” or cracking of the lens, which can significantly reduce the lens clarity and effectiveness of the lamp and may require replacement of the complete lamp housing.
- Some popular citric acid cleaners may cause polycarbonate lenses to become “hazy” or “foggy”.
- Do not use a pressure washer to clean headlights.
- Inspect and operate the lights regularly to confirm proper operation and mounting condition.

INTERIOR SOFT GOODS

We recommend a weekly routine of vacuuming all fabrics and carpet throughout the motor home to prevent an accumulation of dirt, which can detract from the appearance and shorten the life of carpet and fabrics.

Fabric Upholstery

Some fabrics used in this motor home may contain fire retardant and lightfastness additives, which can be damaged by use of improper

cleaning products. Some water-based household cleaning products are not formulated for use on fabrics and may cause excessive shrinkage or fading. Always test any cleaning product on a hidden area of fabric before using on visible areas. For best results, fabric cleaning should be referred to a professional carpet and upholstery cleaner.

NOTE: To minimize fading of upholstery, carpets and other interior fabrics caused by excessive sunlight, the drapes, blinds, or shades should be closed when the motor home is parked for an extended period of time.

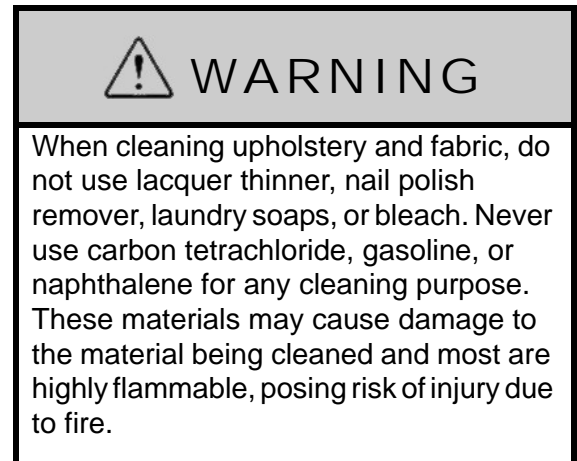

Ultraleather™ Leather-Like Upholstery –If Equipped

Ultraleather synthetic leather fabric material has the luxurious look and feel of the finest European calfskin, with the durability and resistance to soils and stains of vinyl fabrics. It is also tougher than real calfskin and has superior resistance to punctures, snags, and rips.

For most soils and stains, the fabric manufacturer recommends spot treatment with a solution of water and Tide® brand laundry detergent or equivalent. More stubborn stains may be treated with a water-based multipurpose cleaner/degreaser such as Simple Green® or equivalent. Solvent cleaners such as nail polish remover or other aromatic solvents are not recommended.

Care Instructions

- Spot clean with mild soap and water.
- Air dry or, if desired, dry quickly using a hair dryer on warm setting - not hot.
- For stubborn stains, use cleaner-degreaser.

These materials are made from polypropylene or polyester synthetic fibers, so they clean very well with virtually no damage to the color or fabric itself.

Most commercially available carpet and upholstery cleaners will do an excellent job removing stains. From time to time, additional cleaning methods may need to be used to remove stubborn or difficult stains.

UltraLeather Cleaning Chart		
Type of Stain	Detergent/ Water	Cleaner/ Degreaser
Coffee, Tea	◆	
Red Wine, Liquor	◆	
Cola, Soft Drinks	◆	
Milk	◆	
Ketchup	◆	
Steak/Soy Sauce	◆	
Mayonnaise, Butter	◆	◆
Salad Oil	◆	◆
Chocolate	◆	◆
Cosmetic Makeup	◆	◆
Lipstick	◆	◆
Face Cream	◆	◆
Suntan Oil/Lotion	◆	◆
Shoe Polish	◆	◆
Urine	◆	◆
Machine Oil		◆

**Vinyl Fabrics (including ceiling)
–If Equipped**

Vinyl should be cleaned with a soft, damp cloth, and a mild detergent only. Do not use solvents. Solvents may damage the surface of the vinyl.

**Draperies, Curtains and
Bedspreads**

These items may be woven from a variety of fabrics. We recommend that these be professionally dry cleaned only. A five percent shrinkage may occur when you have these items dry cleaned.

CEILING FABRIC CARE

While using your coach, your ceiling fabric may become soiled and require spot cleaning from time to time.

The following cleaning chart is provided as a guideline for care and cleaning of ceiling fabrics used in your coach.

CEILING FABRIC STAIN REMOVAL		
Type of Stain	Cleaning Agent	How to Remove
Mustard	Dry-Clean Solvent	Scrub-Soak-Blot Dry
Ketchup*	High Strength Detergent	Scrub-Soak-Blot Dry
Coffee*	High Strength Detergent	Scrub-Soak-Blot Dry
Chocolate*	Detergent	Scrub-Soak-Blot Dry
Tea	High Strength Detergent	Scrub-Soak-Blot Dry
Chewing Gum	Dry-Clean Solvent	Scrub-Soak-Blot Dry
Oil	High Strength Detergent	Scrub-Soak-Blot Dry
Grease	High Strength Detergent/Degreaser	Scrub-Soak-Blot Dry
Tar/Asphalt	K-1 Kerosene/Thinner	Scrub-Soak-Blot Dry
Wax	Detergent	Hot Iron on Detergent-Soaked Towel/Cloth
Rust	Rust Remover	Scrub-Soak-Blot Dry
Dirt*	Detergent	Scrub-Soak-Blot Dry
Lipstick	Dry-Clean Solvent	Soak-Blot Dry
Nail Polish	Dry-Clean Solvent	Soak-Blot Dry
Shoe Polish	Dry-Clean Solvent	Soak-Blot Dry
Crayon	High Strength Detergent	Scrub-Soak-Blot Dry
Marker (indelible)	Detergent	Scrub-Soak-Blot Dry
Ink (Ballpoint Pen)	Dry-Clean Solvent	Soak-Blot Dry
Pencil Lead (Graphite)	Detergent	Scrub-Rinse-Blot Dry
Vomit*	High Strength Detergent	Scrub-Rinse-Blot Dry-Deodorize w/Vinegar
Urine*	High Strength Detergent	Scrub-Rinse-Blot Dry-Deodorize w/Vinegar
Blood*	High Strength Detergent	Scrub-Rinse-Blot Dry
Excrement*	High Strength Detergent	Scrub-Rinse-Blot Dry-Deodorize w/Vinegar

NOTE: In many cases listed above, repeated steps may be required to fully extract contaminant from material. Items listed above with () may also be removed through steam extraction method by a professional cleaner or service. Always check to see that the cleaner used will not cause damage to the material or fabric by testing on an area out of sight.*

Water Stains

Water stains should be cleaned with a mixture of 1/4 cup of white powdered or clear liquid laundry detergent (no coloring) in a bucket of warm water. Working with a clean sponge or white cloth, start from the outside of the stain and work your way to the center. This method will

keep the stain from spreading. Do not over saturate as this may cause delamination. No need to scrub, simply rub lightly or dab the stain.

You may have to repeat this procedure more than once to achieve desired results. Finish up with clean water, using the same method, and blot dry.

Steam cleaning is also an option. Again, take care not to over-saturate the material.

REMEMBER, this is polypropylene (basic plastic) so do not be afraid to clean it.

CABINETRY – CLEANING

Wooden items may be cleaned with a soft cloth and a good quality wood finish cleaning product.

Vinyl simulated wood panels may be cleaned with a mild, water-based cleaner and a soft cloth. Do not use solvents on vinyl wood panels.

NOTE: Many cabinetry and furniture items throughout this motor home are constructed either partially or completely of real hardwoods. Because of natural variations in woodgrain density, slight differences in stain hue may exist between one item and another. This is the distinctive character and beauty of real wood.

TABLES AND COUNTERTOPS

Work surfaces are covered with a plastic or thermo-formed laminate that resists solvents, stains, and abrasions. A coat of furniture wax applied to these surfaces on the counters and table will help preserve their beauty and make cleaning easier. Always clean the surface before applying wax.

GALLEY SINK

Acrylic

Care and Cleaning Instructions

The galley sink has been designed and engineered to resist scratches and should not stain under normal household use if used properly.

To keep this product looking its best, we recommend that you take a few easy precautions.

General Cleaning

Clean often with hot water and soap. If a cleanser is necessary, make sure the product is recommended for use on plastics.

Avoid harsh abrasive cleaners, ammonia, or citric-based products as discoloration may result.

Rinse all food, beverage, or cosmetic residue from the sink as soon as possible. Some residues, if left to sit in the sink, may require the use of detergent or a mild liquid or gel-type kitchen surface cleaner.

If acids or medicine spill on the surface, wash the spills immediately.

Hard-to-Remove Food and Beverage Residue

For most stubborn stains, fill the sink about one quarter full with a 50/50 solution of bleach and water. After 10 or 15 minutes of soaking, drain solution from the sink as you rinse both sides and bottom.

NOTE: Do not use steel wool or metal scouring pads.

Marks or Discoloration

A color-matched automotive scratch remover compound may be used to remove stubborn marks or discoloration. Always follow label directions.

NOTE: Improper use may damage this product and void the warranty.

RANGE AND REFRIGERATOR

For care and appearance maintenance of the range and refrigerator, refer to the appliance manufacturer's operation and maintenance manuals included in your InfoCase.

BATHROOM

Toilet

For instructions on the care of your toilet, refer to the information in your InfoCase.

Tub and Shower Walls

The tub and shower walls in the bathroom should be cleaned with mild soap and warm water. Do not use an abrasive cleaner on the shower walls and tub, as scratching and discoloration may occur. Stubborn stains may be removed with an automotive-type cleanser.

Lavatory Sink

Do not use abrasive cleaners, harsh detergents, or solvents.

General Cleaning. Rinse all food, beverage, or cosmetic residue from the sink as soon as possible. Some residues, if left to sit in the sink, may require the use of detergent or a mild liquid or gel abrasive cleaner.

Hard-to-Remove Food and Beverage

Residue. Use an abrasive cleanser such as Ajax[®], Comet[®], Bon Ami[®] or Bar Keeper's Friend[®] to remove mild stains and for routine cleaning. Use an abrasive pad such as Scotch-Brite[®] to remove most of the tougher stains.

For the most stubborn stains, fill the sink about one quarter full with a 50/50 solution of bleach and water. After 10 or 15 minutes of soaking, drain solution from the sink as you rinse both sides and bottom.

NOTE: Do not use steel wool or metal scouring pads.

Mineral-Based Stains. Cleaners designed to remove iron or rust should not harm the sink, nor will solvents such as denatured alcohol, mineral spirits, or acetone.

Marks or Discoloration. White automotive rubbing compound may be used to remove stubborn marks or discoloration. Use of these products will not damage the solid surface. Always follow label directions.

DOORS AND WINDOWS

Windows may be periodically cleaned with a good quality glass cleaner or mild soap solution using a soft cloth.

Use care when removing ice or frost from the windows. Always use a plastic ice scraper, never one made of metal. Use care when removing ice from the mirrors to protect the reflective surfaces.

Door locks and hinges should be lubricated periodically with powdered graphite to ensure trouble-free operation and to protect against freeze-up.

VEHICLE STORAGE – PREPARATION

Properly preparing your vehicle for storage will lessen the possibility of damage to your vehicle. Prepare the motor home for vacancy just as you would if you were leaving your house for an extended period.

Clean and Prep Coach for Storage

1. Turn off the propane gas tank.
2. Turn the furnace thermostat switch OFF.
3. **Remove all foods and items that may cause odors from cabinets and refrigerator.**
4. Clean and defrost the refrigerator. Prop the door open slightly to allow any odors to dissipate. Place an open box of baking soda inside the refrigerator to help absorb odors.
5. **Fully charge the batteries. Batteries must have at least 80% charge to survive freezing temperatures and long period of non-use.** We recommend that you connect a battery charger or plug in the shoreline once a month during long-term storage periods to maintain battery charge and to avoid sulfating. If connecting a charger directly to batteries, turn the Aux/Coach Battery Switch off to avoid electrical arcing when attaching and detaching charge clamps.

NOTE: We do not recommend leaving the shoreline plugged in continuously during storage periods because the batteries can lose electrolytic fluids and become damaged from continuous charging without periodic use. We recommend following regular battery inspection and maintenance especially in cold weather. See "Battery Care" in the Electrical section.

6. After charging batteries, turn the Aux/Coach Battery Switch off to disconnect the batteries and avoid parasitic* drain.

** Parasitic battery drain is the gradual drain by items connected directly to battery power such as clocks, radio memory, and the engine computer.*

7. Have the vehicle chassis completely serviced and lubricated. Be sure radiator antifreeze protection level is sufficient for the lowest anticipated temperatures.
8. Wash and wax the coach.
9. Inspect all seams and seals around doors, windows, vents, and any other joints. Replace or repair any that are damaged. Sealing

materials and compounds can be purchased from your dealer. Badly damaged weather seals may need to be replaced by your dealer.

10. Close all windows and roof vents. Protect all appliance vent openings from contamination by animals or insects (e.g. bird nest, wasp nests, etc.)
11. Lubricate all door hinges and locks.
12. Clean the interior of the coach. Dirt and stains are more easily removed when fresh.

If you are storing your vehicle through the winter, or in cold climates, extra preparations must be made to protect equipment and systems that can be damaged by freezing temperatures. See *Winterizing Procedures* in Plumbing section.

VEHICLE STORAGE – REMOVAL

1. Completely air out the motor home.
2. Have the entire LP gas system checked for leaks.
3. Check window operation.
4. Check cabinet and door hinges. Lubricate with penetrating oil, if necessary.
5. Close all faucets and drain valves that are open.
6. Add a few gallons of water to the fresh water tank and turn on the water pump to check for leaks, especially at fittings.
7. Open all faucets in turn to release trapped air and check to be sure faucet washers have not hardened during storage.
8. Sanitize the water system as outlined under *Disinfecting the Fresh Water System* in the Plumbing section, then flush the waterlines thoroughly with fresh water.
9. After flushing fresh waterlines, install a new water filter cartridge on the galley sink water filter and/or full-coach water filtration system (if equipped). See appropriate filter installation instructions in Plumbing section.

NOTE: Always purge a new filter with clean running water before using. See filter manufacturer's directions included with the filter cartridge.

10. Check the toilet for proper operation.
11. Add water to the holding tank using the toilet flush pedal and galley sink faucet. Check to be sure dump valves seal tightly.
12. Check around all appliances for obstructions and ensure that all vent openings are clear.
13. Start refrigerator and check for proper cooling.
14. Clean wall and counter surfaces.
15. Replace batteries, if necessary, and check out electrical system to make sure all lights and electrical components operate.
16. Check tires for proper cold inflation pressure. See *Vehicle Certification Label* in Introduction section.
17. After washing accumulated winter grime from the vehicle, it is important to carefully inspect the seams and sealants for separation or cracks that may have appeared around the window frames, vents, and any other joints. See *Sealants – Inspection and General Information* at the beginning of this section. Re-sealing is quite simple and the material is quickly and easily applied. Appropriate compounds are available from your dealer. See *Sealants – Recommended Application* page in the Supplement Manual provided in your InfoCase. Also inspect weather seals around doors, etc., and if necessary, have a dealer replace immediately.

Ice Maker Start-Up –If Equipped

1. Close all drain valves.
2. Turn the water supply on.
3. Be sure the ice bin is in place and the automatic shutoff arm is down.
4. Let the refrigerator cool down to ice making temperature. Remember, this can take up to 24 hours.

5. Let the ice maker cycle and dump the first batch of ice.

**SECTION 11 –
MAINTENANCE AND STORAGE**



COACH MAINTENANCE CHART

These recommendations apply for normal recreational use. Heavy duty or full-time use may require more frequent maintenance intervals.

Always use specified sections or manufacturer's guide for further information and instructions.	Before Each Use	Weekly	Monthly	Every 3 Months	Every 6 Months	Every Year	As Necessary
Propane Gas System							
Have propane gas system checked for leaks						◆	◆
Pressure Regulator - inspect and adjust if needed						◆	
Check propane tank condition, mounting, and fittings						◆	
Electrical System							
Check Battery Condition Meter	◆						
Check battery fluid level and connections			◆				
Check 12V fuses and 120V breakers							◆
Check GFCI Receptacles			◆				
Generator							
Visually inspect generator and compartment	◆						
See generator manufacturer's maintenance guide							◆
Plumbing System							
Sanitize plumbing system							◆
Winterize plumbing system							◆
Clean water pump strainer filter						◆	◆
Slideout & Leveling System							
Check and Adjust							◆
Check Hydraulic Oil Level			◆				◆
Check Hydraulic Lines (routing, leaks, etc.)						◆	
Check and inspect room seals (bulb seals)					◆		◆
Exterior							
Clean roof				◆			◆
Clean sidewalls			◆				◆
Clean windows							◆
Flush underside of vehicle				◆			◆

COACH MAINTENANCE CHART

These recommendations apply for normal recreational use. Heavy duty or full-time use may require more frequent maintenance intervals.

Always use specified sections or manufacturer's guide for further information and instructions.	Before Each Use	Weekly	Monthly	Every 3 Months	Every 6 Months	Every Year	As Necessary
Safety Equipment							
Check operation of the following items:							
Headlights, Taillights, and Marker Lights	◆		◆				
Turn Signals	◆		◆				
Horn	◆		◆				
Hazard Warning Flashers	◆		◆				
Windshield Wipers and Washers	◆		◆				
Fire Extinguisher - check charge indicator	◆		◆				
Smoke Alarm - test operation *	◆		◆				
Carbon Monoxide Alarm - test operation *	◆		◆				
Propane Gas Leak Detector - test operation	◆		◆				
(*replace battery if needed)							
Appliances							
Water Heater							
See water heater manufacturer's maintenance guide							◆
Inspect and clean exterior vent	◆						◆
Refrigerator							
See refrigerator manufacturer's maintenance guide							◆
Inspect and clean exterior vent/drip tray drain tube	◆						◆
Furnace							
See furnace manufacturer's maintenance guide							◆
Inspect and clean exterior vent	◆						◆
Air Conditioner							
See A/C manufacturer's maintenance guide							◆
Inspect for exterior damage				◆			◆
Check/replace filter			◆				
Range Top							
See range manufacturer's maintenance guide							◆
Inspect and clean/replace range hood grease filter							◆

**SECTION 11 –
MAINTENANCE AND STORAGE**



COACH MAINTENANCE CHART

These recommendations apply for normal recreational use. Heavy duty or full-time use may require more frequent maintenance intervals.

Always use specified sections or manufacturer's guide for further information and instructions.	Before Each Use	Weekly	Monthly	Every 3 Months	Every 6 Months	Every Year	As Necessary
Sealants							
Inspect (see "Sealants" at the beginning of this section for proper inspection technique)					◆		◆
Replace (see "Sealant Call-out Sheet in the supplement manual provided in your InfoCase)							◆
Frame & Chassis							
Follow chassis manufacturer's maintenance guide (refer to chassis manual)							◆
Inspect Hitch Receiver (if towing)	◆						
Tires							
Check and adjust air pressure	◆						◆
Check tread wear	◆						◆
Check front end alignment and adjust if needed							◆
Miscellaneous							
Lubricate locks, hinges, and latches						◆	◆

LOADING THE VEHICLE

NOTE: Your motor home's load capacity is designated by weight, not by volume, so you cannot necessarily use all available space when loading your motor home.

- Store or secure all loose items inside the motor home before traveling. Possible overlooked items such as canned goods or small appliances on the countertop, cooking pans on the range, or free-standing furniture items can become dangerous projectiles during a sudden stop or evasive maneuver.
- Be aware of GVWR, GAWR, and individual load limit on each tire or set of duals.

When loading the vehicle, distribute the cargo load equally so that you do not exceed either the Front or Rear Gross Axle Weight Rating (GAWR) or the Gross Vehicle Weight Rating (GVWR). The Gross Axle Weight Rating (GAWR) means the weight value specified by the chassis manufacturer as the load carrying capacity of a single axle system as measured at the tire-to-ground interfaces. This is the total weight a given axle is capable of carrying. Each axle has its own rating.

Have your vehicle weighed to determine the proper load distribution for your vehicle. Also distribute cargo side-to-side so the weight on each tire or dual set does not exceed one half of the GAWR for either axle.

For example, if the Front GAWR is 6,000 lbs., there should be no more than 3,000 lbs. on each tire. (If the left side weighs 3,100 lbs. and the right side weighs 2,700 lbs., at least 100 lbs. of the load must be shifted from the left side to the right side.) The GVWR is listed on the Vehicle Certification Label. (See sample in Specifications section).

The GCWR (Gross Combination Weight Rating) means the maximum allowable loaded weight of this motor home and any towed trailer or towed vehicle.

NOTE: We recommend that you dump all holding tanks before traveling to avoid carrying unnecessary weight.

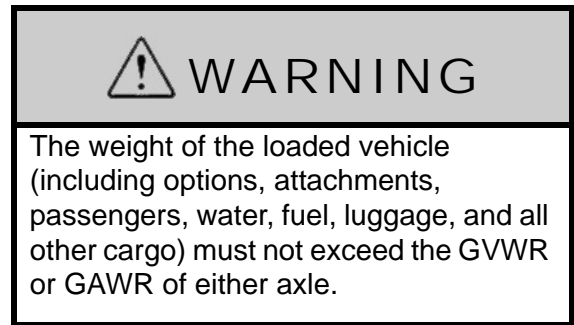

WEIGHING YOUR LOADED VEHICLE

To check the weight of your fully loaded coach, locate a commercial weighing scale that is capable of weighing large trucks.

NOTE: Sales literature may give approximate or standard weights. Your actual coach weight may differ based on added factory and/or dealer options.

Loading

Load your vehicle completely as if you were going on a long trip with everything you would carry, including food, clothing, bedding, lawn chairs, etc., a full fuel tank, full propane tank, and a partial tank of fresh water, but empty holding tanks.

Finding a Scale

In urban areas, the most common places to find a public access scale are commercial truck stops. In rural areas, most grain storage elevators have scales available. Most scales charge a nominal fee for weighing a vehicle.

Weighing

There is typically a scale operator to direct you, but the basic routine is to take three separate weights - front axle, whole vehicle, and rear axle.

You will first drive only your front wheels onto the scale pad, then drive ahead so that the whole vehicle is on the scale, then finally pull off until just the rear wheels are on the pad.

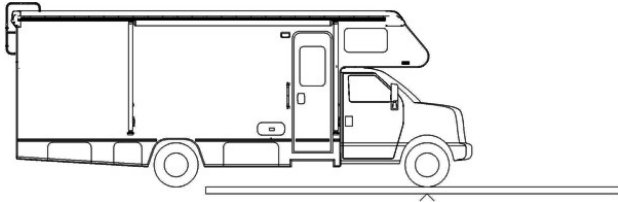

Front GAWR (Front Axle Only)

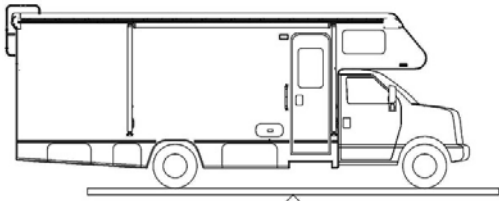

GVWR - Whole Vehicle (All Axles)

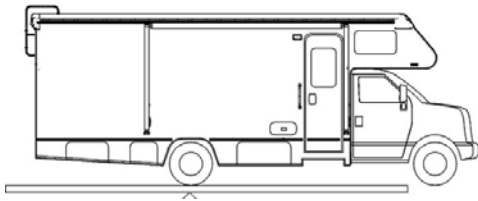

Rear GAWR (Rear Axle Only)

You will receive a weight “ticket” that states your current Front Gross Axle Weight, Rear Gross Axle Weight, and Gross Vehicle Weight. You can compare these weights to the weight ratings listed on your Vehicle Certification Label to use as a guideline for future loading limits and weight distribution.

The gross weight of the vehicle must not exceed the Gross Vehicle Weight Rating (GVWR) specified on the Vehicle Certification Label. The front and rear axle weight also should not exceed the corresponding Axle Weight Rating specified on the Vehicle Certification Label.

Corner Weighing (Side-to-Side)

The most accurate method of weighing a motor home is to weigh each “corner” of the coach separately (single L/R front wheels or L/R rear dual sets.) This method will help you determine how to distribute your cargo to avoid overloading, especially on tires.

To determine the weight distribution on each tire or dual set, you will need to find a scale capable weighing side-to-side, or all four “corners” of the vehicle separately.

A truck scale may be used if the ground is level with the scale surface and the scale has clearance to drive one side of the coach onto the scale as shown.

Drive the coach on the level area next to the scale and straddle the scale so that only one side of the coach will be on the scale pad.

NOTE: Wind and precipitation can also cause weight inaccuracies.

Pull only the right front wheel onto the scale pad as shown.

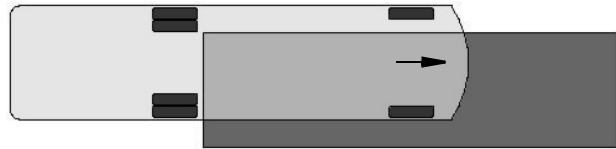

Weighing Right Front Corner

When the front wheel has been weighed, pull the coach straight ahead until only the right rear wheel/dual set is on the scale pad as shown.



Weighing Right Rear Corner

Now, turn the coach around and repeat the process for the other side.

The load on each wheel or dual-wheel set should not exceed one-half of the corresponding GAWR. For example, if the GAWR for the rear

axle is 12,000 lbs., then the load on each rear dual set (left rear duals or right rear duals) should not exceed 6,000 lbs.

Tires must be filled to the recommended air pressure for the highest loaded tire set on that axle. For example, on the rear axle, if the left side weighs more than the right, fill the left tires to the pressure required for that weight, then fill the right tires to the same pressure as the left ones.

If your actual weight is considerably less than GAWR, you may be able to lower your tire pressure. See a tire dealer for a load/pressure chart.

NOTE: The Hitch Load from a Towed Vehicle or carrier box must also be counted on the Rear GAWR and subtracted from the rear axle cargo capacity.

Be aware that hitch load can affect handling characteristics. The more weight on the hitch, the lighter the front end will feel at the steering wheel.

CAR OR TRAILER TOWING

Hitch Pulling Capacity

5,000 lbs. max.

Tongue Weight

350 lbs. max.

The factory installed towing hitch on this coach is capable of pulling 5,000 lbs. load (max.), however, the vertical (tongue) weight may vary according to chassis and model combinations. (*see label on hitch). Towing capacity may be less than hitch rating.

When towing a trailer or vehicle, do not exceed either the GVWR, the rear axle GAWR, or the chassis GCWR by the combined loaded weight of the coach and the towed vehicle. See preceding items “Loading the Vehicle” and “Weighing Your Loaded Vehicle” for explanation of weight ratings.

Because of individual vehicle use and loading habits, we recommend weighing the vehicle while fully loaded to avoid exceeding any of the

listed Gross Weight Ratings. See “Vehicle Certification Label” in the Introduction section for information on gross weight ratings.

Towing will affect vehicle handling, durability, and fuel economy. Exceeding any of the listed Gross Weight Ratings will result in unacceptable overall vehicle performance. Maximum safety and satisfaction when towing depends on proper use of correct equipment.

When towing a vehicle behind your motor home, the tow bar should be level or pointing slightly upward towards the tow vehicle.

When coupling the vehicle tow bar to the Factory Receiver Hitch using a “drop receiver” or a conventional “ball mount” (commonly referred to as a “stinger” or a draw bar”), do not exceed a 4” drop, nor one that the centerline of the hitch pin to the centerline of the ball exceeds 8”. (Reference Hitch Assembly sketch).

If a towing “brake system” is required, we recommend that a “modulated” towed vehicle braking device be installed. This means that when the motor home brakes are applied, whether hard or soft, a mirror effect occurs in the braking of the towed vehicle. In other words, the more force applied to the motor home brakes, the more force will be applied to the rear vehicle’s braking system.

We do not recommend the usage of a “surge-style” braking device. The usage of a surge brake (especially when coupled with a hitch ball located outside our recommended limits) places excessive stress on the hitch. This abuse of the ball mount and the hitch may cause premature hitch assembly failure.

Finally, do not forget to consider the actual tongue weight. This should not exceed the stated hitch vertical load for your vehicle. This weight is typically defined as the tongue weight of a towed vehicle hitch, boat trailer tongue weight, or a receiver-mounted carrier rack.

Check state regulations on trailer weight and trailer brake requirements to be sure you select the right equipment before towing.

Before descending a steep or long grade when towing a trailer, reduce speed and shift into a lower gear to control vehicle speed. Avoid prolonged or frequent application of brakes, which could cause overheating and brake failure.

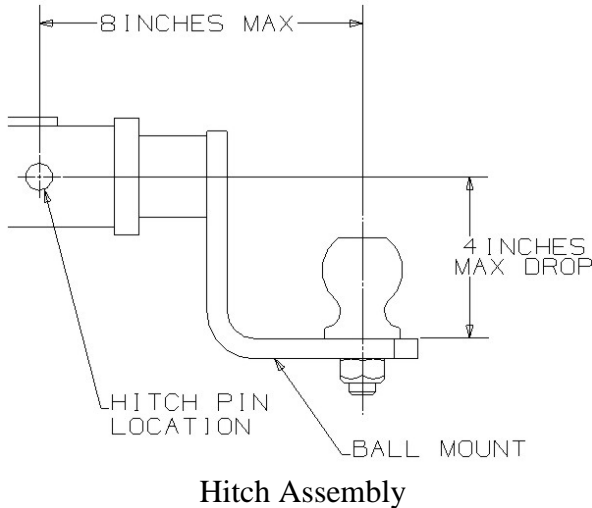

! WARNING

For safe towing and vehicle handling, maintain proper trailer weight distribution. The total weight of the motor home and the vehicle towed must not exceed the Gross Combined Vehicle Weight rating. See the Body and Chassis Specification chart in the Introduction section.

NOTICE

Exceeding any of the recommended gross vehicle weight ratings may result in vehicle damage. Do not install a frame equalizing-type hitch on your vehicle.

**TRAILER WIRING
CONNECTOR**

Your coach is pre-wired for trailer or car towing lights with a 7-pin socket. The connector plug is supplied in the coach parts package provided to you by your dealer when you took delivery of the vehicle.

The following diagram shows proper connection of trailer or tow vehicle wiring to the coach light system. The “pigtail” assembly with the (car/trailer end) connector plug should be wired by a qualified technician. Provision for an electric brake controller is located near the steering column.

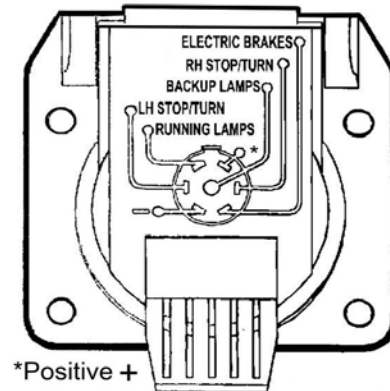

TOWING GUIDELINES

Gross Vehicle Weight Rating (GVWR)

This is the maximum allowable weight of the fully loaded vehicle. Included are fuel, water, LP, passengers, cargo, tools, and optional equipment installed by the motor home manufacturer, dealer, or owner. This value is found on the VIN label, typically placed near the driver position.

Gross Axle Weight Rating (GAWR)

This is the total weight a given axle is capable of carrying, measured at the ground. Each axle has its own rating. These values are also found on the Vehicle Certification Label: front and rear.

Gross Combination Weight Rating (GCWR)

This is the maximum allowable weight of the motor home and loaded trailer, including the items noted in GVWR above. For purposes of this definition, the “trailer” can be a trailer, a vehicle towed on a dolly, or a vehicle towed by means of a tow bar. GCWR is typically specified based on durability and performance of the tow vehicle drive train: engine and cooling systems, transmission, drive line, drive axle, and others. The tow vehicle brakes may be rated for operation at GVWR, not GCWR.

*NOTE: State or provincial laws/regulations may require the “trailer” to be equipped with brakes that are activated when the motor home brakes are applied. **The user is responsible to know and understand the laws of the state or province being traveled.** The Department of Transportation in a given state or province should be able to provide specific information.*

Hitch Ratings

SAE Standard J684 defines:

- Class 1 trailers as “GVWR not to exceed 2,000 lbs”.
- Class 2 trailers as “GVWR over 2,000 lbs. and not to exceed 3,500 lbs. GVWR”.
- Class 3 trailers as “GVWR over 3,500 lbs. and not to exceed 5,000 lbs. GVWR”.
- Class 4 trailers as “GVWR over 5,000 lbs. and not to exceed 10,000 lbs. GVWR”.

Hitches are to be permanently marked with “Maximum trailer GVWR to be drawn” and “Maximum vertical tongue weight to be imposed.” The SAE standard does not specify a vertical load rating.

Traditionally, hitches are labeled 3,500/350 as Class 2, 5,000/500 as Class 3, and 10,000/1,000 as Class 4. The vertical tongue load value of 10 percent of drawn rating comes from the collective experience that 10 percent is the minimum value that provides stable towing of a trailer.

Ford’s towing guide suggests 10 to 15 percent for trailers over 2,000 lbs. Within GCWR, a Class 3 hitch allows “dingy” towing a large car or mid-size SUV; a Class 4 hitch allows “dingy” towing a large SUV or pickup. (Hitch ratings are independent of towing vehicle ratings.)

NOTE: Some Winnebago Industries® models equipped with a Class 3 hitch may have a label limiting vertical tongue load to 350 lbs. All Winnebago Industries models equipped with a Class IV hitch have a label limiting vertical tongue load to 500 lbs. On a 228" wheelbase, a 500-lb. load on a hitch 11' from the rear axle will apply about 800 lbs. at the axle.

The user must verify that the hitch equipment being used is adequate for the application.

ENTRY STEP – MANUAL

–If Equipped

To extend the entry step, lift up on the front of the step and pull out until it drops into position. To retract, lift up on front of step and push back until step locks into travel position.



Always remember to store the entry step before traveling or moving the vehicle.

ENTRY STEP – ELECTRIC

–If Equipped

 WARNING
Do not use step unless fully extended. Do NOT stand on step when vehicle ignition switch is turned to either the “On” or “Start” position. The step will automatically retract, which may cause personal injury.

The power switch for the electric entry step is located to the left of the main entry door as you enter the coach.



Entry Step Switch
(Located near entrance door)
-Typical View

The step has several automatic extend/retract functions that are controlled by the position of a sensor mounted on the inner edge (hinge side) of the screen door.

Automatic Mode - Entry Step Switch ON
(Step Operates with Door)

With the Step switch in the ON position, the step is in Automatic Mode. This means it will extend and retract automatically whenever the screen door is opened or closed.



Red Activation Lever

- The red Activation Lever located on the entry step switch must be depressed in order to put the step switch in the ON position.

Stationary Extended Mode - Step Switch OFF
(Step Remains Extended)

With the Step power switch in the OFF position, the step will extend when the screen door is opened and will stay extended whether the door is opened or closed.

This position is normally used to keep the step extended when parked at a campsite or whenever people will be going in and out the vehicle frequently.

Automatic Retraction Feature

The step is equipped with an automatic retraction feature that stores the step automatically if the main entry door is closed and the Ignition Switch key is turned to the On or Run positions.

The step **WILL RETRACT** even if the Step switch is OFF.

This feature is intended to prevent injury or damage by an extended step while the vehicle is moving.

Further Information

For additional information on the step, see the manufacturer’s operators manual included in your InfoCase.

WINDOWS

Crank-Out Windows

- Turn the crank-out handle from the horizontal position to the vertical position.

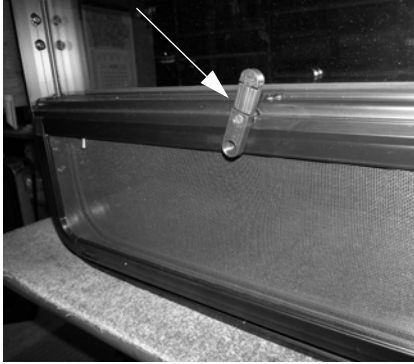

- Pull out the lever on the crank-out handle and begin cranking out the window counter-clockwise to the position desired.

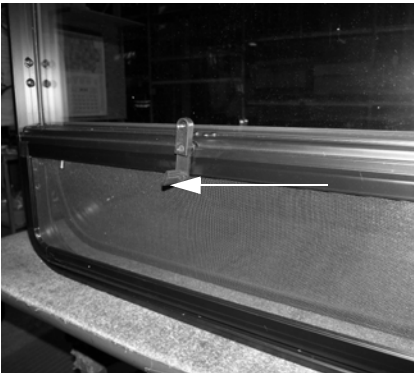

- To close, crank the window in snugly (by turning the crank-out handle clockwise), then back off 1/4 turn to help avoid glass warping, which can result in wind noise.
- Push the lever back in on the crank-out handle and lay back in the horizontal position.

If the window will not open after three or more full turns of the knob, the glass may be stuck to the sealing gasket. Go to the outside of the coach and gently free the glass with your fingers. A periodic light dusting of talcum powder on the gasket should prevent this from recurring.

Horizontal Slider Windows

Swing the latch handle straight out or up (depending on the style of window). Grasp the sliding window edge frame and slide the window to the side. Be sure the latch is open before trying to slide the window closed.

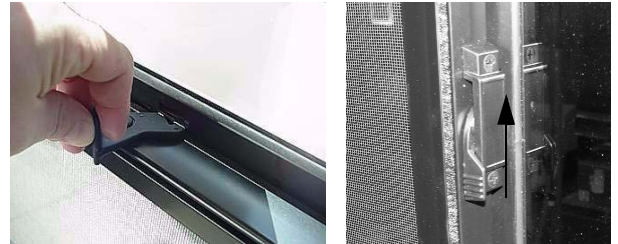

Vertical Slider Windows

Vertical windows have spring-loaded catches on both sides of the window that pop out to hold the window in its fully raised position. Press the catches outward toward the frames while lowering the window.



Vertical Window Catches

POWER ROOF VENTILATOR

Lounge, Galley, or Bath Area –If Equipped

The vent dome is raised and lowered using the Dome Crank knob on the fan.

The turbine fan will start automatically as the vent is raised, and stop as the vent is lowered.

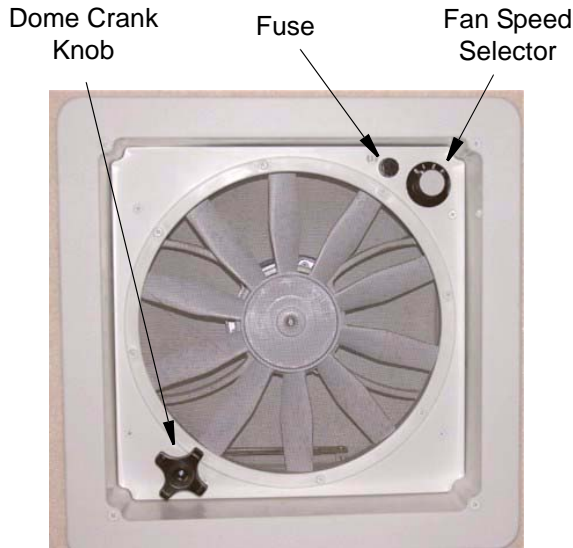

Power Roof Ventilator

To Operate Ceiling Ventilator

1. Turn the Dome Crank Knob to raise the dome about 3" or more to allow the turbine fan to operate. (*A built-in safety switch will not let the fan motor run unless the dome is partially open.*)
2. The turbine fan will start automatically as the vent dome is raised and stop as the vent dome is lowered and closed. (*Fan Speed knob must be in a position other than 0-Off.*)
3. Turn the Fan Speed knob to the desired level (1-Low, 2-Med, 3-Hi).
4. Open a window or door to provide airflow. Direction of airflow is determined by which window or door is opened.

NOTE: For best results, close all other roof vents, windows, and doors, then open one (1) window the farthest distance from the roof ventilator. The fan speed selector on the fan allows you to adjust the amount of circulation you need at any time.

5. If you want the vent dome raised without the fan running, turn the Fan Speed knob to 0-Off.

Further Information

See the power ventilator manufacturer's operating instructions supplied in your InfoCase for further instructions, care, and cleaning information.

MANUAL AWNING

-If Equipped

Further Information

For complete operating instructions, refer to the manufacturer's information provided in your InfoCase.

STORAGE COMPARTMENT DOORS

The high-density gaskets used on the exterior storage compartments are designed to provide a more positive seal against dust and weather. Sometimes this seal firmness can inhibit complete latching of the compartment doors if they are simply "dropped shut" or closing force is applied only to the center of the door.

To ensure that exterior storage compartment doors have latched properly, press firmly on the bottom edges (side edges - if equipped) of the doors with the palms of your hands. If the door is ajar you will hear and feel a loud "click" when the latches engage properly.

TOOL AND LADDER STORAGE

The roof ladder extension and various tools supplied with your coach are stored in one or more of the exterior storage compartments.

NOTE: Actual features and locations may vary depending on model, available equipment, and storage compartment configuration.

ROOF LADDER

–If Equipped

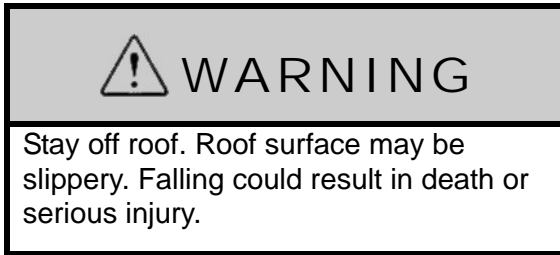

The ladder on your motor home is provided for limited access to the roof.

Walking or working on the roof should be left to qualified service personnel using proper safety equipment in a safe environment. You should only walk or work on the roof if you are qualified and have created a safe environment.

For your safety, it is not recommended that you store or carry items on the roof.

Before Using the Ladder

- **Inspect the ladder** to make sure it is not damaged. Never use a damaged ladder.
- **Keep the rungs of the ladder clean and dry** while in use. Never use the ladder when it is raining, snowing, or icy. The rungs can become slippery. Do not step onto the rungs if the rungs are wet, or if your shoes are wet or carry mud or debris that could result in a loss of footing.
- **Never ignore warning labels** or weight limits defined on your ladder. The following warning label is located on or near the ladder:

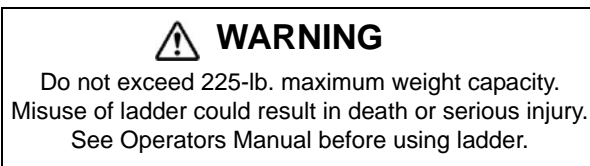

- **Maximum Capacity: 225 lbs.**
- **Do not overload.** Ladder is intended for one person.
- **Make sure you are physically capable** to safely use the ladder. Strength, flexibility, and stability are required.

- **Be aware that the vehicle may sway** as you climb the ladder. Do not use the ladder in high winds.
- **As you climb the ladder,** grasp the side rails firmly and always use both hands. Keep your body centered between the side rails. Do not over-reach.
- **Never allow children** on the ladder.
- **Do not transport items** anchored to the ladder. You could damage the ladder.

EFFECTS OF PROLONGED OCCUPANCY

Your motor home was designed primarily for recreational use and short-term occupancy. If you expect to occupy your coach for an extended period, be prepared to deal with condensation and humid conditions that may be encountered.

Humidity and Condensation

Moisture condensing on the inside of windows is a visible indication that there is too much humidity inside the coach. Excessive moisture can cause water stains or mildew, which can damage interior items such as upholstery and cabinets.

When you recognize the signs of excessive moisture and condensation in your coach, you should take immediate action to minimize their effects.

You can help reduce excessive moisture inside the motor home by taking the following steps:

Ventilate with outside air

Partially open one or more windows and a roof vent to circulate outside air through the coach. In cold weather, this ventilation may increase use of the furnace, but it will greatly reduce the condensation inside the coach.

Minimize moisture released inside the coach

Run the range hood fan while cooking and open a bath vent while bathing or showering to carry water vapor out of the coach. Avoid making steam from boiling water excessively or letting

**SECTION 12 –
MISCELLANEOUS**

OUTLOOK

hot water run. Avoid bringing extra moisture into the coach by way of soaked clothing or snow on shoes. Do not hang-dry wet overcoats or clothing inside the coach.

OUTLOOK

INDEX

2010 New Vehicle Limited Warranty	1-7	Engine Cooling System	3-9
About this Manual	1-1	Engine Overheat	2-10
Air Conditioner Filter	4-10	Entry Step – Electric	12-6
Air Conditioner/Heater – Automotive (Dash)	3-5	Entry Step – Manual	12-5
Air Springs – Rear Helper	3-10	Exterior Automotive Paint Finish	11-2
Audio-Video System Basic Operation	8-5	Exterior Entertainment Center	8-9
Bathroom	11-8	Exterior Lights	11-5
Battery Access	6-6	Exterior Shower/Wash Station	7-5
Battery Boost Switch	3-4	External Power Cord	6-1
Battery Care	6-6	Fire Extinguisher	2-4
Cabinetry – Cleaning	11-7	Fold-Down Dinette Seat	3-1
Cable TV Hook-Up	8-9	Formaldehyde Information	2-7
Car or Trailer Towing	12-3	Fresh Water System	7-1
Carbon Monoxide Alarm	2-3	Front Axle Tire Alignment	1-2
Carbon Monoxide Warning	2-3	Front Overhead Bunk	9-1
Care of Appliques and Decals	11-4	Front TV Ignition Switch Interlock	8-2
Ceiling Fabric Care	11-6	Fuel and Propane Gas	2-1
Checking Hydraulic Oil Level	10-11	Furnace-A/C Thermostat Operation Chart ..	4-9
Child Restraints	3-2	Galley Sink	11-8
Circuit Breakers – House 120-Volt AC	6-3	General Slideout Care	10-9
Circuit Breakers and Fuses – House 12-Volt ..	6-8	General Warnings	2-1
Coach Maintenance Chart	11-12	Ground Fault Circuit Interrupter	6-3
Cold Water Filter	7-3	Hazard Warning Flashers	3-3
Dinette/Bed Conversion	9-2	Heat Pump	4-9
Dinette/Bed Conversion	9-3	Holding Tank Heater	7-7
Disinfecting Your Fresh Water System	7-4	House Battery Disconnect Switch	6-6
Doors and Windows	11-9	Interior Soft Goods	11-5
Driving Safety	2-1	Jump Starting	2-10
Ducted Roof Air Conditioning System	4-10	KeyOne™ Lock System	3-3
DVD Home Theater System	8-5	Keys	3-3
DVD Player	8-6	Leveling System	10-9
Effects of Prolonged Occupancy	12-9	Lights	3-10
Electrical	2-5	Loading	2-5
Electrical Cautions	6-1	Loading the Vehicle	12-1
Electrical Generator – 120-Volt	6-4	LP Gas Leaks	2-2
Electrical Inverter	8-7	Maintenance	2-5
Electrical Outlets – House 120-Volt AC	6-3	Manual Awning	12-8
Electrical System – House 120-Volt AC	6-1	Microwave Oven/Range Hood	4-3
Electrical System – House 12-Volt DC	6-5	Mirrors – Power sideview Exterior	3-4
Emergency Exits	2-5	Mold, Moisture, and Your Motor Home	2-7
Engine Access – Interior	3-9	MotorAid Water Heater	4-6
		Mountain Driving	3-10

Occupant and Cargo Carrying Capacity	Sofa Air Bed (Comfort Sofa Sleeper)	9-5
Label	Sofa/Bed Conversion	9-2
Owner and Vehicle Information	specifications and Capacities	1-5
Plastic Parts – Cleaning	Storage Compartment Doors	12-8
Pleated Blinds	Suspension Alignment and Tire Balance	3-9
Power Center	Swing-Out TV Mounts	8-2
Power Roof Ventilator	Systems Monitor Panel	4-4
Pre-Delivery Inspection	Tables and Countertops	11-8
Pressure-Temperature Relief Valve	Tires	3-9
Propane Gas Furnace	Toilet	7-5
Propane Gas Leak Detector	Tool and Ladder Storage	12-8
Propane Gas Pressure Regulator	Towing Guidelines	12-4
Propane Gas Supply	Trailer Wiring Connector	12-4
Propane Gas Warnings and Precautions	TV - Removable (Interior/Exterior)	8-2
Propane Vaporization in Cold Weather	TV Antenna	8-7
Radio – In-Dash	TV Digital Satellite System – Manual	8-9
Radio In-Dash/Rearview Monitor System	TV Signal Amplifier	8-8
Range and Refrigerator	TV/DVD Master Power Switch (12-Volt)	8-2
Range Top	Undercarriage	11-1
Refrigerator	U-Shaped Dinette/Bed Conversion	9-4
Refrigerator Service Access Compartment	Vehicle Certification Label	1-4
Reporting Safety Defects	Vehicle Storage – Preparation	11-9
Roadside Emergency	Vehicle Storage – Removal	11-10
Roof	Video Selection System	8-1
Roof and Ladders	Waste Water System	7-6
Roof Ladder	Water Heater – Gas	4-5
Safe Use of the Propane Gas System	Water Heater - Gas/ Electric	4-5
Safety Messages Used in this Manual	Water Heater Bypass Valve	7-8
Sealants –	Water Pump	7-2
Inspection and General Information	Water System Drain Valve Locations	7-16
Seat Belts	WaterLine & Tank Drain Valves	7-7
Seats – Driver/Co-Pilot	Weighing Your Loaded Vehicle	12-1
Service and Assistance	Windows	12-7
Shower Hose Vacuum Breaker	Winterizing Optional Appliances	7-14
Sirius® Plug and Play Satellite Radio	Winterizing Procedures	7-9
Sleeping Facilities	Wood Furniture and Cabinetry	9-9
Slideout Emergency Retraction - Bedroom		
Slideout Emergency Retraction – Electric		
Slideout Room –		
Extreme Weather Precaution		
Slideout Room Operation – Electric		
Slideout Room Travel Lock		
Slideout Room Troubleshooting – Electric		
Slideout Rooms		
Smoke Alarm		
