

Congratulations! We welcome you to the exciting world of motor home travel and camping. You will find it convenient and enjoyable to have all the comforts of home and still enjoy the great outdoors wherever you choose to go.

Your motor home has been carefully designed, engineered and manufactured to provide dependability as well as safety. Before sliding into the driver's seat, take a few minutes to become familiar with operations and features. This manual was prepared to aid you in the proper care and operation of the vehicle and equipment. We urge you to read it completely. In addition, spend some time with the dealer when you take delivery, you will want to learn all you can about your new motor home.

Your new motor home is covered by a factory warranty against defects in material and workmanship. This warranty should be validated at once and returned to the factory by your dealer.

Read and understand all instructions and precautions in this manual before operating your new motor home. Throughout this manual, certain items are labeled NOTE, CAUTION and WARNING. These terms alert you to precautions that can involve risk to your vehicle or to your personal safety. Read and follow them carefully.

NOTE: Indicates a special point of information.

CAUTION

Indicates that a failure to observe can cause damage to vehicle or equipment

WARNING

This symbol is used to alert you to precautions that involve your personal safety as well as vehicle damage. Read and follow them carefully.

OWNER'S NAME
STREET ADDRESS
CITY AND STATE (OR PROVINCE IN CANADA)
MOTOR HOME SERIAL NUMBER
VEHICLE CHASSIS IDENTIFICATION NO. (VIN)
DATE OF DELIVERY TO FIRST RETAIL PURCHASER
VEHICLE MILEAGE AT TIME OF DELIVERY
SELLING DEALER NAME AND ADDRESS

TANK CAPACITIES	
Vehicle Fuel Tank	
Chevy Chassis	75 gal.
Ford Chassis	75 gal.
Freightliner Diesel Chassis	90 gal.
LP GAS TANK	
Models 33WB, 34WY, 35WH & 36WL (Chevy/Ford Chassis)	*23 gal.* (28 gal. w.c.)
Models 36WL (Freightliner chassis)	*31 gal.* (39 gal. w.c.)
Fresh Water Tank	
Models 33WB & 35WH	70 gal.
Models 36WL (Freightliner chassis)	86 gal.
Model 34WY & 36WL (Chevy/Ford chassis)	100 gal.
Water Heater	
All Models	6 gal.
Black Water Holding Tank (Tank 1)	
Model 33WB, 34WY & 36WL (Toilet)	55 gal.
Model 35WH (Toilet & Lavatory)	55 gal.
Gray Water Holding Tank (Tank 2)	
Model 33WB, 34WY & 36WL (Galley, Shower & Lavatory)	53 gal.
Model 35WH (Galley & Shower)	53 gal.

*LP Gas tank capacity shown is the usable "full" LP gas capacity, which is 80% of the tank manufacturer's listed water capacity (w.c. shown in parenthesis). An LP tank must have at least 20% of tank volume free to allow for expansion and proper vaporization of the liquid fuel. The tank is also equipped with mandatory safety shut-off equipment that prevents filling above this level.



TABLE OF CONTENTS

INTRODUCTION

Vehicle Chassis Manual.....	0-1
Motor Home Operations Manual (Binder).....	0-1
Before Driving.....	0-1
Service Assistance.....	0-2
Drinking and Driving.....	0-2
Reporting Safety Defects.....	0-2
Vehicle Certification Label.....	0-3
Exterior Feature Identification.....	0-4

SECTION 1: SAFETY PRECAUTIONS

General Warnings.....	1-1
Driving.....	1-1
Fuel & LP Gas.....	1-2
LP Gas Leaks.....	1-2
LP Gas Alarm.....	1-3
Electrical.....	1-3
Loading.....	1-4
Maintenance.....	1-4
Formaldehyde Warning.....	1-4
Carbon Monoxide Warning.....	1-4
Carbon Monoxide Alarm.....	1-5
Emergency Exit Window.....	1-5
Fire Extinguisher.....	1-6
Smoke Alarm.....	1-7

SECTION 2: DRIVING YOUR MOTOR

HOME

Before Entering.....	2-1
Before Driving.....	2-1
Fuel Information.....	2-2
Fuel Tank Fill.....	2-2
Fuel Tank Capacity.....	2-2
Starting and Stopping Engine.....	2-2
Engine Block Heater (Freightliner).....	2-3
Parking Brakes.....	2-4
Engine Exhaust Brake (Freightliner).....	2-5
Hazard Warning Lights.....	2-5
Door Locks and Handles.....	2-5
Keys.....	2-6
Power Door Locks.....	2-6
Power Window (Driver's).....	2-6
Keyless Entry System (Remote Locks).....	2-6
Entrance Step.....	2-6
Luggage Compartment Doors.....	2-6

Seats.....	2-6
Seat Belts.....	2-8
Child Restraints.....	2-9
Power Mirrors.....	2-9
Rearview Monitor System.....	2-10
Instrument Panel.....	2-11
Cruise Control.....	2-12
Comfort Controls.....	2-12
Heating.....	2-12
Defrosting.....	2-13
Ventilation.....	2-13
Air Conditioning.....	2-13
Rear Auto Heater.....	2-13
Stereo Sound Systems.....	2-13
Radio/Cassette Player.....	2-13
Radio Power Switch.....	2-13
Deluxe Sound System.....	2-13
Compact Disc Changer.....	2-14
Auxiliary Start Switch.....	2-14
Auxiliary Battery Switch.....	2-14
CB Radio Wiring.....	2-14
Coach Leveling Systems.....	2-15
Jet Air Ride Park & Level System.....	2-16
Slide-Out Room.....	2-17 - 2-20
Travel Latches.....	2-17
Extending.....	2-18
Retracting.....	2-18
Emergency Crank-In.....	2-19

SECTION 3: IN CASE OF DRIVING

EMERGENCY

Hazard Flashers.....	3-1
Spare Tire.....	3-1
Tire Changing	
Safety Precautions.....	3-2
Front Wheel.....	3-2
Dual Rear Wheels.....	3-3
Wheel Nuts.....	3-3
Recovery Towing.....	3-3
Jump Starting.....	3-4
Connecting a Battery Charger.....	3-4
Engine Overheat.....	3-5

SECTION 4: TRAVELING WITH YOUR MOTOR HOME

Loading the Vehicle.....	4-1
Front Axle Tire Alignment.....	4-1

TABLE OF CONTENTS



Weighing Your Loaded Vehicle	4-1	Trailer Wiring Connector.....	6-10
Maximum Occupancy	4-1	SECTION 7: PLUMBING SYSTEMS	
Roof Loading	4-2	Fresh Water System	7-1
Trailer Towing	4-2	Filling Water Tank.....	7-1
Pre-Travel Checklist	4-3	Fresh Water Tank Capacity	7-1
Travel Tips.....	4-3	Water Pump	7-1
Severe Weather Information.....	4-4	Water Pump Switch	7-2
Nighttime Driving.....	4-5	Accumulator Tank	7-2
Mountain Driving	4-5	External (City Water) Connector.....	7-3
Campsite Selection	4-5	Disinfection of Water Tank	7-3
Leveling	4-6	Water Purifier System.....	7-4
Blocking.....	4-6	Shower Hose Vacuum Breaker.....	7-4
Effects of Prolonged Occupancy	4-6	Exterior Shower	7-4
Humidity and Condensation	4-6	Drainage System (Waste)	7-5
SECTION 5: LP GAS SYSTEM		Dumping Holding Tanks	7-5
LP Gas Supply	5-1	Flushing Black Water Tank.....	7-5
Safe Use of LP Gas System	5-1	Using On-Site Sewer Hook-Ups.....	7-6
How LP Gas Works	5-1	Water Drain Valves	7-6
Selecting Fuel Types.....	5-1	Holding Tank Capacities	7-7
LP Tank System	5-2	Water System Drain Valve	
Refilling Tank.....	5-2	Locations.....	7-8
Air in the LP Gas Tank.....	5-3	SECTION 8: APPLIANCES AND	
Traveling with LP Gas.....	5-3	INTERIOR FEATURES	
Regulator.....	5-3	Refrigerators	8-1 - 8-5
LP Gas Leaks.....	5-4	Range and Oven.....	8-5
Winter Use of LP Gas.....	5-5	Microwave Oven.....	8-6
SECTION 6: ELECTRICAL SYSTEMS		Range Hood and Monitor Panel.....	8-6
110-Volt AC System.....	6-1	Tank Level Checking.....	8-7
External Power Cord (Shoreline).....	6-1	Water Heater.....	8-7
Connecting the Shoreline.....	6-2	By-Pass Valve.....	8-8
PowerLine Energy Management		Motor Aid Water Heater.....	8-9
System.....	6-2	LP Gas Furnace.....	8-9
110-Volt Circuit Breakers.....	6-3	Central Air Conditioner	8-10
Power Converter System	6-3	TV Antenna.....	8-10
Charging Section.....	6-4	TV Signal Amplifier	8-11
Overload Protector.....	6-4	Cable TV Hook-Up	8-12
Inverter/Charger, 1500W - Optional	6-4	Video Control Center.....	8-12
110-Volt Receptacles (Outlets).....	6-4	Satellite TV System - Optional	8-12
Ground Fault Circuit Interrupter		DC-AC Electrical Voltage Inverter ...	8-13
(GFCI).....	6-4	Exterior Entertainment Center	8-13
Auxiliary 110-Volt Generator		Sleeping Facilities	
Operating Instructions.....	6-5	Couch/Bed Conversion	8-13
12-Volt DC System	6-7	Dinette/Bed Conversion.....	8-13
Automotive (Starting) Battery	6-7	Fresh Water Toilet	8-14
Coach Battery	6-7	Power Roof Vent	8-15
Solar Charger Panel	6-8	Crank-Out Windows	8-15
Battery Access (Storage).....	6-8	Slider Windows.....	8-15
Battery Maintenance	6-9	Day/Night Pleated Shades	8-15

Quartz Wall Clock	8-15
SECTION 9: CARE AND MAINTENANCE	
Roof	9-1
Underbody	9-1
Exterior	9-1
Waxing and Polishing	9-1
Stripes and Decals, care of.....	9-1
Compartment Doors.....	9-2
Interior Maintenance	
Upholstery, Carpeting and Draperies	9-2
Cabinets	9-3
Vinyl Wallboard	9-3
Tables and Countertops	9-3
Stainless Steel Sink.....	9-3
Bathroom	9-3
Doors and Windows.....	9-3
Vehicle Maintenance	
Chassis Service and Maintenance.....	9-4
Engine Access.....	9-4
Fuel/Water Separator, Diesel	9-5
Engine Cooling System	9-5
Tires	9-5
Suspension Alignment and Tire Balance.....	9-5
Windshield Washers and Wipers	9-6
Lights	9-6
Automotive 12-Volt Circuit Breakers	9-6
SECTION 10: STORING YOUR MOTOR HOME	
Preparing Vehicle for Storage.....	10-1
Cold Weather Storage (Winterizing).....	10-1, 10-3
RV Antifreeze Winterization	
Systems	10-4
Remove from Storage	10-5

Congratulations on the purchase of your new Sunflyer motor home, which has been carefully designed, engineered and quality built by Winnebago Industries, Inc.

OPERATOR'S MANUAL

Please read this operator's manual thoroughly. It was prepared in order to provide you with information necessary to properly and safely operate your new motor home.

This manual describes those instruments, controls and instructions which are unique to this motor home. For information regarding all other equipment, controls and instructions not described herein, we urge you to read the "Chassis Operating Guide" and the equipment manufacturer's information provided in your "Motor Home Operation Manual".

This manual should be kept in the vehicle at all times for personal reference. The operator's manual, motor home operation manual and chassis operating guide are to be considered permanent components of this vehicle. They should remain in the vehicle when sold to provide the next owner with important safety, operating and maintenance information.

NOTE: The descriptions, illustrations, and specifications in this manual were correct at the time of printing. We reserve the right to change specifications or design without notice, and without incurring obligation to install the same on products previously manufactured.

CHASSIS OPERATING GUIDE

Throughout this manual, frequent reference is made to the vehicle chassis operating guide. The chassis guide is the operator's manual provided by the manufacturer of the chassis on which this motor home is built (i.e., Chevrolet, Ford, Freightliner, etc.). Consult the chassis guide for operating safety and maintenance instructions pertaining to the chassis section of the motor home.

MOTOR HOME OPERATION MANUAL (Binder)

Your Motor Home Operation Manual contains information supplied by manufacturers of individual appliances and equipment installed in your motor home.

Consult this information regarding the operation and care of appliances, accessories and special equipment.

OPTIONS AND EQUIPMENT

This model is available in several sizes and floorplans, so accessories and components may differ slightly between models. Some equipment described in this manual may not apply to your coach.

BEFORE DRIVING

Before sitting in the driver's seat, always check around your vehicle to be sure you have proper clearance for maneuvering. If necessary, have a passenger help guide you out of a difficult parking space.

Although your coach features automotive conveniences like power steering and power brakes, driving a motor home is different from driving a car. A motor home is larger and heavier than an automobile, so it requires more stopping and passing distance, and more parking and maneuvering space than does a car.

Always be aware of the size of your motor home. The added height of roof air conditioners, TV antennas or luggage boxes may cause clearance problems around some tunnels, canopies and hanging signs. Know the height of your unit so you can observe posted clearance limits. Also, remember that some bridges, old ones in particular, may not support the weight of your motor home. Know the weight of your unit and observe any posted weight limits.

Remember: Always use your seat belt and be sure your passengers do so as well. We also advise making frequent rest stops while traveling to relieve stress on yourself, your passengers and your vehicle.

SERVICE AND ASSISTANCE

Your dealer will be glad to provide any additional information you need, as well as answer any questions you might have about operating the equipment in your motor home. When it comes to service, remember that your dealer knows your vehicle best and is interested in your satisfaction. Your dealer will provide quality maintenance and any other assistance that you may require during your ownership of this vehicle.

If you need warranty repairs while traveling, however, you may take your motor home to any Winnebago or Itasca dealership and they will assist you.

WARRANTY

Your new vehicle is covered by a factory warranty against defects in material and workmanship. This warranty should be validated immediately and returned to the factory by your dealer. For additional information, see your "New Vehicle Limited Warranty" included with this vehicle.

DRINKING AND DRIVING

Winnebago Industries supports the recommendations of the Presidential Commission on Drunk Driving.

- Exercise your good judgment and encourage others to do the same.
- Know the legal limits and do not exceed them.
- Also know your personal limits, which may be lower than the legal limits.
- Should you ever exceed your limits, find alternative transportation; call a cab, ask a friend to drive you home or call a family member to come and get you.

The presence of alcohol in significant levels in the blood increases the probability that the driver will be involved in an accident.

REPORTING SAFETY DEFECTS

If you believe that your vehicle has a defect which could cause a crash or could cause injury or death, you should immediately inform the National Highway Traffic Safety Administration (NHTSA) in addition to notifying Winnebago Industries, Inc.

If NHTSA receives similar complaints, it may open an investigation, and if it finds that a safety defect exists in a group of vehicles, it may order a recall and remedy campaign. However, NHTSA cannot become involved in individual problems between you, your dealer, or Winnebago Industries.

To contact NHTSA, you may either call the Auto Safety Hotline toll-free at 1-800-424-9393 (or 366-0123 in Washington, D.C. area) or write to: NHTSA, U.S. Department of Transportation, Washington, D.C. 20590. You can also obtain other information about motor vehicle safety from the Hotline.

VEHICLE CERTIFICATION LABEL

This label contains vehicle identification and other important reference information. The vehicle certification label is located on the sidewall to the left of the steering wheel, or on the driver's door. Never remove or destroy this label.

MANUFACTURED BY 		INCOMPLETE VEHICLE MANUFACTURED BY ① MOTOR CORP. MONTH AND YEAR OF MANUFACTURE: ② GVWR ④ LB _____ KG _____	
GAWR: ③ _____ FRT _____ LB _____ KG _____ RR. ⑤ _____ LB _____ KG _____		SUITABLE TIRE AND RIM CHOICE TIRE _____ RIM _____ COLD INFLATION PRESSURE PSI _____ KPA _____	
THIS VEHICLE CONFORMS TO ALL APPLICABLE FEDERAL MOTOR VEHICLE SAFETY STANDARDS IN EFFECT ON THE DATE OF MANUFACTURE SHOWN ABOVE. SERIAL NO. ⑩ _____ VIN ⑪ _____ TYPE ⑫ _____ MODEL ⑬ _____ COLOR ⑭ _____			

EXPLANATION OF DATA

1. Chassis manufacturer.
2. Chassis manufacture date.
3. Month and year of manufacture at Winnebago Industries.
4. Gross Vehicle Weight Rating: Total permissible weight of the vehicle, including driver, passengers, total cargo carried (including all liquids) and equipped with all options.
5. Gross Axle Weight Rating: Total permissible weight allowed for the front, intermediate* and rear axles (listed in pounds and kilograms).
6. Suitable Tire Choice: Tires recommended to meet handling and safety requirements. When replacing any of the tires on your vehicle, always replace with a tire that meets these specifications.
7. Suitable Rim Choice: Wheel rims recommended to meet handling and safety requirements. When replacing any of the rims on your vehicle, always replace with a rim that meets these specifications.
8. Cold Inflation Pressure: Inflation pressures recommended (while Cold) for the tires originally equipped on your vehicle. These pressure levels must be maintained to assure proper handling, safety and fuel economy.
9. Intermediate* and Rear Axle Wheel Configuration: Single or Dual.

10. Serial Number: This is the serial number assigned to the completed vehicle by Winnebago Industries.
11. Vehicle Identification Number (VIN): This number identifies the chassis on which the motor home is built.
12. Type: States the NHTSA designated usage classification for your motor home. MPV signifies a Multi-purpose Passenger Vehicle.
13. Model: Lists the Winnebago product model number of your vehicle.
14. Color: Signifies the color code number of the decor used throughout the vehicle. This number is necessary for ordering replacement cushions, curtains, carpet, etc.

*Intermediate (INT) data applies only to Class-A models equipped with tag axle.

EXTERIOR FEATURE IDENTIFICATION

Composite model shown for illustration purposes only.
Actual locations of features depends on coach model and options.

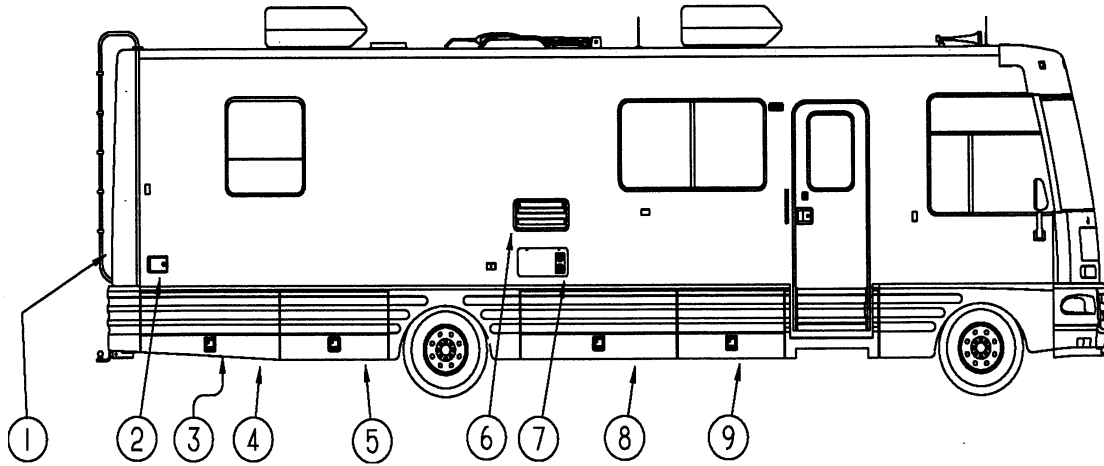

- | | |
|----------------------------------|--------------------------------|
| 1. Trunk Compartment | 6. Refrigerator Service Access |
| 2. Fresh Water Tank Gravity Fill | 7. Furnace Service Access* |
| 3. Spare Tire Carrier | 8. Storage Compartment** |
| 4. Storage Compartment | 9. Storage Compartment |
| 5. LP Gas Tank Compartment | |

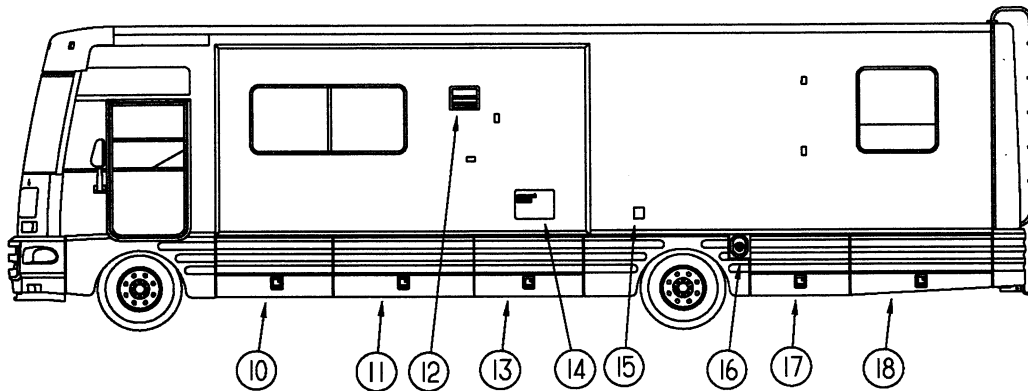

- | | |
|----------------------------------|---|
| 10. Storage Compartment | 15. Shoreline-Coach Input Connection |
| 11. Storage Compartment | 16. Fuel Fill |
| 12. Range Hood Vent Outlet | 17. Utility Systems Compartment |
| 13. Storage Compartment | 18. Aux. Electric Generator Compartment |
| 14. Water Heater Service Access* | |

NOTE: Some equipment shown may be optional.

*CAUTION: Be careful. These features may become HOT while water heater or furnace are in use.

**Also contains Exterior Entertainment Center

Read and understand all instructions and precautions in this manual before operating your new motor home. Throughout this manual, certain items are labeled NOTE, CAUTION and WARNING. These terms alert you to precautions that can involve risk to your vehicle or to your personal safety. Read and follow them carefully.

NOTE: Indicates special point of information.

CAUTION

Indicates that a failure to observe can cause damage to vehicle or equipment.

WARNING

This symbol is used to alert you to precautions that involve your personal safety as well as vehicle damage. Read and follow them carefully.

Listed below are some safety precautions that must be adhered to. These precautions as well as others that involve damage to equipment are also listed in the appropriate areas in this manual.

GENERAL WARNINGS

- Only seats equipped with seat belts are to be occupied while the vehicle is moving.
- Make sure all passengers have seat belts fastened in a low and snug position so the force exerted by the belt in a collision will be spread across the strong hip area. Pregnant women should wear a lap-shoulder belt whenever possible, with the lap belt portion worn low and snug throughout the pregnancy.
- All moveable or swiveling seats should be placed and locked in forward facing positions while the vehicle is moving.
- Never let passengers stand or kneel on seats while the vehicle is moving.
- Sleeping facilities are not to be utilized while vehicle is moving.
- Examine the escape window and be familiar with its operation, but do not use except in an emergency.
- Inspect the fire extinguisher monthly for proper charge and operating condition. This should also be done before beginning a vacation or any extended trip.

DRIVING

- Do not attempt to adjust the driver's seat while the vehicle is moving.
- Do not adjust tilt steering in a moving vehicle.
- Do not operate the cruise control on icy or extremely wet roads, winding roads, in heavy traffic, or in any other traffic situation where a constant speed cannot be maintained.
- Use care when accelerating or decelerating on a slippery surface. Abrupt speed changes can cause skidding and loss of control.
- Driving through water deep enough to wet the brakes may affect stopping distance or cause the vehicle to pull to one side. Check brake operation in a safe area to be sure they have not been affected. Never operate any vehicle if a difference in braking efficiency is noticeable.
- Adverse weather conditions and extremes in terrain may affect handling and/or performance of your vehicle. Refer to your chassis manual for related information.

SECTION 1 SAFETY PRECAUTIONS

Sunflyer

FUEL & LP GAS

- All pilot lights must be extinguished and appliances turned off while refilling the fuel tank or LP tank.
- Never smoke while refilling vehicle fuel tank or LP gas tank.
- Avoid inhaling exhaust gases produced by burned gasoline, diesel fuel or LP gas in items such as the range, chassis engine, generator engine, refrigerator, furnace and water heater. They contain carbon monoxide, which is an odorless, colorless and poisonous gas.
- Do not bring or store LP gas containers, gasoline or other flammable liquids inside the vehicle because a fire or explosion may result. LP gas containers are equipped with safety valves which relieve excessive pressure by discharging gas to the atmosphere.
- Do not fill LP gas container(s) above 80 percent of capacity. Overfilling the LP gas container can result in uncontrolled gas flow which can cause fire or explosion. A properly filled container will contain approximately 80 percent of its volume as liquid LP gas.
- Never use an open flame to test for LP gas leaks. Replace all protective covers and caps on LP system after filling. Make sure valve is closed and door latched securely.
- Never connect natural gas to the LP gas system.
- When lighting range burners do not turn burner controls to "On" and allow gas to escape before lighting match.
- Portable fuel-burning equipment, including wood and charcoal grills and stoves, shall not be used inside the recreational vehicle. The use of this equipment inside the recreational vehicle may cause fires or asphyxiation.
- LP gas regulators must always be installed with the diaphragm vent facing downward.

Regulators are equipped with a protective cover. Make sure that the regulator vent faces downward and that the cover is kept in place to minimize vent blockage which could result in excessive gas pressure causing fire or explosion.

- The following warning label is located in the cooking area to remind you to provide an adequate supply of fresh air for combustion.

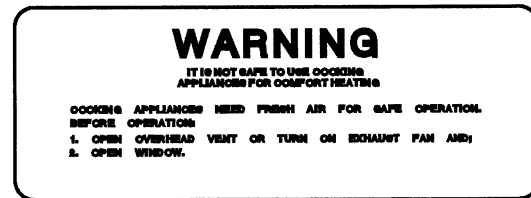

Unlike large homes, the oxygen supply inside a recreational vehicle is limited due to its size. To avoid danger of asphyxiation, provide proper ventilation when using the gas rangetop or gas oven. It is especially important that the gas oven and range top not be used for comfort heating. Danger of asphyxiation is greater when these appliances are used for long periods of time.

LP GAS LEAKS

The following label is located in the vehicle near the range area. If you smell gas within the vehicle, quickly and carefully perform the procedures listed.

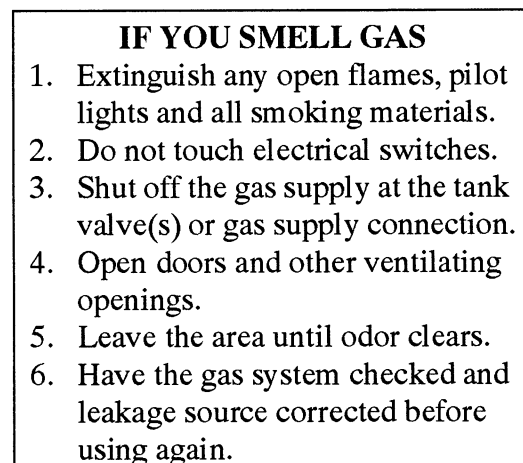

LP GAS ALARM

Your coach is equipped with an LP gas detector which sounds an alarm if an unsafe amount of LP gas is present inside the coach. Because LP gas is heavier than air, the detector is located on a cabinet face near the floor of the coach.

A green light on the face of the alarm shows when the unit is active. If the detector senses LP gas, the alarm will make a loud, pulsating sound and the red light will come on. Pressing the "MUTE" button will stop the alarm for 60 seconds. If there is no more detectable LP gas, the alarm will stay off. If the detector still senses LP gas by the end of the 60 second mute mode, the alarm will sound again.

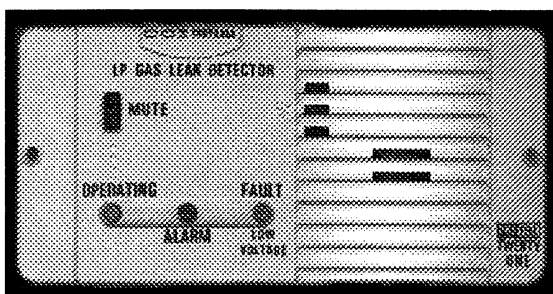

If The Alarm Sounds

If the alarm sounds, do not touch any electrical switches. Immediately turn off the main LP tank valve and all LP appliances, open all windows and roof vents, and leave the coach until the alarm stops sounding.

If the alarm keeps sounding at regular intervals, a leak may be present. Contact your dealer or an LP gas service center to have the problem corrected before using the LP system again.

WARNING

Never use an open flame to test for gas leaks. When testing for gas line leaks with a soapy water solution, DO NOT use a detergent containing ammonia or chlorine. These substances may generate a chemical reaction causing corrosion to gas lines, resulting in dangerous leak conditions.

Power Connection

The gas alarm is powered by the coach batteries. If the battery cable is disconnected from the batteries, auxiliary battery switch is shut off, or the fuse is blown, the alarm will not work. The LP gas alarm breaker is located on the coach circuit breaker panel shown on page 6-7.

Because the LP gas alarm is connected directly to the auxiliary battery, it is always drawing a small amount of current. Even though this current draw is slight, it could drain the coach battery during storage periods of 30 days or longer. We recommend turning the auxiliary battery switch off or disconnecting the battery cables from the auxiliary battery during extended storage periods to avoid discharge.

If the coach batteries become extremely drained (8.5 volts or less), the amber Low Voltage/FAULT light on the face of the alarm will come on, and in some rare cases the LP alarm may begin to sound on its own. This condition is not likely to occur except during storage situations when coach battery charge is not being restored by the converter charger or solar charger.

Other Combustible Fumes or Vapors

This alarm is designed to detect the presence of LP gas, however there are other combustible fumes or vapors which may be detected by the sensor. These include: alcohol, liquor, deodorants, colognes, perfumes, wine, adhesives, lacquer, kerosene, gasoline, glues, most all cleaning agents and the area is closed up. Glues and adhesives may exhaust hydrocarbon vapors for months after they are applied. They are easily activated by high temperatures. If you close up an RV coach on a hot day, the chemicals used in its construction may be detected for months after the coach was manufactured.

Further Information

See the manufacturer's information entitled "Your LP Gas Detector" in the operations manual binder for further instructions on nuisance alarms and care and testing of the LP gas detector.

ELECTRICAL

- Careless handling of electrical components can be fatal. Never touch or use electrical

SECTION 1 SAFETY PRECAUTIONS

Sunflyer

components or appliances while feet are bare, while hands are wet, or while standing in water or on wet ground.

- Improper grounding of the vehicle can cause personal injury. Do not plug the utility power cord into an outlet which is not grounded and do not adapt the plug to connect to a receptacle for which it is not designed.
- Do not attach an extension cord to the utility power cord.
- Be sure that all electrical appliances to be used contain 3-prong plugs for proper grounding.
- Avoid overloading electrical circuits. Replace fuses or circuit breakers with those of the same size and amperage rating only. Never use a higher rated fuse or breaker.
- Use caution when handling or working near electrical storage batteries. Always remove jewelry and wear protective clothing and eye covering. Avoid creating sparks.

LOADING

- Store or secure all loose items inside the motor home before traveling.
- Be aware of GVWR, GAWR and individual load limit on each tire or set of duals. (See "Loading the Motor Home" in Section 4.)
- Never load the motor home in excess of the gross vehicle weight rating or the gross axle weight rating for either axle.

MAINTENANCE

- Do not remove the radiator cap while engine and radiator are still hot. Always check coolant level visually at the see-through coolant reservoir.
- Never get beneath a vehicle that is held up by a jack.
- Do not mix different construction types of tires on the vehicle such as radial, bias or belted tires, as vehicle handling may be affected.

Replace tires with exact size, type and load range.

- Do not attempt to start the vehicle by hot wiring.

FORMALDEHYDE INFORMATION

WARNING

Some components in this vehicle contain formaldehyde based adhesives which may release formaldehyde fumes into the air for an unknown period of time until total dissipation occurs. Individuals who are allergic to formaldehyde gas fumes may experience irritation to eyes, ears, nose and throat. Reaction in infants may be more severe. Although long range effects are not well understood, testing to date has not revealed any serious health effects in humans at the level of emission from these products.

IMPORTANT

To aid in dissipation, ventilate the vehicle by opening all windows and circulating the air with a fan.

CARBON MONOXIDE WARNING

WARNING

Avoid inhaling exhaust gases, as they contain carbon monoxide, which is a colorless, odorless and poisonous gas.

If you suspect that exhaust fumes are entering the passenger compartment, have the cause determined and corrected as soon as possible. If you must drive under these conditions, drive only with **ALL WINDOWS FULLY OPENED**.

The best protection against carbon monoxide entry into the vehicle body is a properly maintained engine exhaust and ventilation system. It is recommended that the exhaust system and body be inspected by a qualified motor home service center.

- Each time the vehicle is raised for an oil change.
- Whenever a change in the sound of the exhaust system is noticed.
- Whenever the exhaust system, underbody or rear of the vehicle is damaged.

To allow proper operation of the vehicle's ventilation system, keep front ventilation inlet grill clear of snow, leaves or other obstructions at all times. **DO NOT OCCUPY A PARKED VEHICLE WITH ENGINE RUNNING FOR AN EXTENDED PERIOD.**

Do not run engine in confined areas, such as a garage, except to move vehicle in or out of area. When vehicle is stopped in an UNCONFINED area with the engine running for any more than a short period, adjust heating or cooling system to force outside air into the vehicle as follows:

1. Set fan to medium or high speed and vent control to air.
2. On vehicles equipped with air conditioning, set fan to medium or high speed and set control to obtain maximum vent air.

Rear windows should be closed while driving to avoid drawing dangerous exhaust gases into the vehicle.

CARBON MONOXIDE ALARM

If your coach is equipped with a carbon monoxide (CO) alarm, it will be located on the ceiling in the bedroom area.

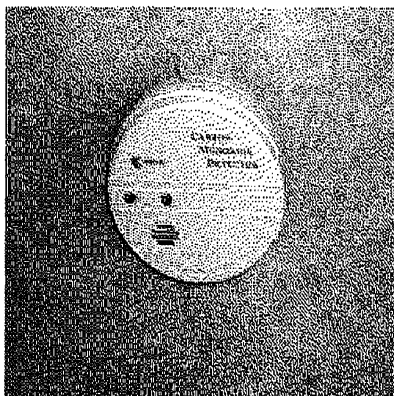

The CO alarm is powered by a 9-volt battery and contains a sensor that is designed to detect toxic carbon monoxide gas fumes resulting from

incomplete combustion of fuel. It will detect CO gas from any combustion source such as the furnace, gas range/oven, water heater, refrigerator, chassis engine, and electric generator engine.

Monthly Testing

Press the TEST button on the face of the alarm periodically (at least monthly) to check the function of the alarm and condition of the battery. If the alarm begins to beep every few seconds, the battery may be weak and need replacement. (Press the TEST button to be sure before replacing the battery. If the alarm sounds, the battery may still be okay. If the alarm still beeps every few seconds, check the smoke detector also. The "low battery" warning beep is similar on many alarm devices, so the origin of this electronic sound can be deceiving.)

Further Information

Please read the information provided by the manufacturer, which is included in your Motor Home Operations Manual binder. It includes information on precautions, operational testing, and battery/sensor replacement.

EMERGENCY EXITS

Emergency Exit Windows

Your motor home is equipped with an emergency exit window in the rear or side of the vehicle which functions as an escape exit in an emergency situation.

Rear Escape Window

In rear escape windows, the glass is installed with a rubber extrusion, it is opened by pulling on the red plastic loop located at the bottom of the window, until the rubber cord is completely removed. This allows the window to be pushed out.

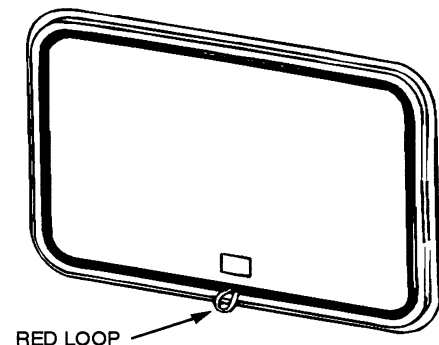

SECTION 1 SAFETY PRECAUTIONS

Sunflyer

Instructions for removal are also located on a label on the glass for quick reference and for passengers who may not be familiar with the exit. Never remove or destroy this label.

WARNING

Use emergency window for emergency exit only. Do not test for proper operation.

If the cord is released by accident, but the glass remains in place, the cord can be replaced using a blunt instrument, preferably one made of plastic. We suggest you contact your dealer for assistance.

WARNING

Use care when exiting emergency window, as broken glass may be present in the exit area.

Side Escape Window

The side mounted escape window is secured by two red safety latches and can be opened by first releasing these two latches and then pushing outward on the lower part of the window. Identify which type of emergency exit window is in your vehicle.

Instructions for removal are also located near the latches for quick reference and for passengers who may not be familiar with the exit. Never remove or destroy this label.

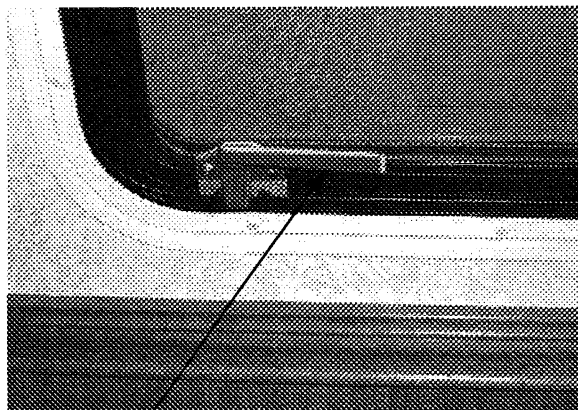

Lift Both Handles Up
Push Out on Bottom

Using Slider Windows as Emergency Exits

Most single and double slider windows along the side of the motor home can also be used as emergency exits, should the need arise. To use the windows as exits, slide the window glass and screen open.

FIRE EXTINGUISHER

A dry chemical fire extinguisher is located near the floor by the side entrance door.



We recommend that you become thoroughly familiar with the operating instructions displayed on the side of the fire extinguisher or in the information supplied in your Motor Home Operations Manual binder.

We also recommend that you inspect the fire extinguisher for proper charge at least once a month in accordance with National Fire Protection Association (NFPA) recommendations as stated on the label.

If the charge is insufficient, the fire extinguisher must be replaced.

WARNING

Do not test the fire extinguisher by discharging it. Partial discharge can cause leakage of pressure or contents which would render the unit inoperative when needed. When using the fire extinguisher, aim the spray at the base of the fire.

5. Smoke alarms have technical limitations and may not respond in all situations. FIRE PREVENTION is your best safeguard.

See your Motor Home Operation Manual binder for further information.

SMOKE ALARM

Your motor home is equipped with a smoke alarm located on the ceiling in the galley area. This alarm meets U.L. Standard 217 and NFPA Standard 74 for operation of smoke detection devices.

1. The smoke alarm should be tested for correct operation each time the vehicle is brought out of storage, before each trip, and at least once a week during motor home use. To test the electronics, firmly depress the button. To test that smoke reaches the sensor, blow smoke in a careful, fire-safe manner into your smoke alarm.

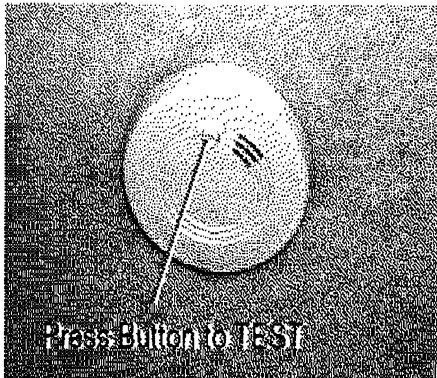

2. Your smoke alarm will not work without power. Never remove the battery to quiet the alarm. When your smoke alarm “beeps” about once a minute the battery is weak. Install a new battery immediately. Be sure to use only batteries specified in manual or on unit. Test unit after installing a new battery.
3. Clean and vacuum the openings on your smoke alarm once a month.
4. Do not open the smoke alarm or try to repair it. For replacement information see warranty in Owner’s Manual.

(See also Safety Precautions, Section 1 of this manual.)

NOTE: See your Chevy, Ford or Freightliner chassis operator's guide for information on starting the engine, operating the transmission, steering column controls descriptions of instrument gauges and other chassis related information.

Some items described in this section may be optional or unavailable on your coach.

BEFORE ENTERING YOUR VEHICLE

Before entering your vehicle, there are a few recommended procedures that will aid in your driving safety and equipment.

1. Be sure that the windows, mirrors and light lenses are clean and unobstructed.
2. Make sure all exterior lights operate properly.
3. Check tires for proper cold inflation pressures.
4. Check wheel lug nuts for tightness.
5. Look beneath the vehicle for noticeable fluid leakage.
6. Check fluid levels and fill if necessary. This includes engine oil, transmission fluid, coolant, brake fluid, power steering fluid and windshield washer solvent.

WARNING

The engine should be shut off unless specifically required for a certain procedure.

Chevy/Ford: Transmission must be in P (Park) and park brake applied while performing any checks or adjustments.

Freightliner: The transmission must be in N (Neutral) and park brake applied while performing any checks or adjustments.

7. Unhook and store sewer and water supply hoses.
8. Retract step.
9. Be sure that all of your cargo is secured in event of a sudden stop or an accident.
10. Check around your vehicle in all directions to assure that you have proper clearance.
11. Lower TV antenna.
12. Disconnect and store shoreline.

WARNING

Before driving your vehicle, be sure you have read the entire operator's manual and that you understand your vehicle's equipment completely and how to use the equipment safely.

BEFORE DRIVING YOUR VEHICLE

Before preparing to drive your vehicle, here are a few recommended procedures that will add to your driving safety and enjoyment.

1. Be sure that you adjust the interior and exterior rear view mirrors to your driving preference.
2. Adjust the driver's seat for proper distance from foot pedals and steering wheel to allow for safety and ease in controlling your vehicle.

3. Place front seats in the forward facing position.
4. Be sure to fasten all safety belts to fit you comfortably, but tight enough to obtain the full safety of the belts.
5. Make sure all doors are completely shut and locked. When the doors are shut and locked, there is less chance of the doors flying open in event of an accident. It also prevents unintentional opening of doors and keeps intruders out of your vehicle.
6. Check to see that all gauges are operating properly.
7. Check the fuel level in the vehicle.
8. Be certain that the fire extinguisher is fully charged and secure in its mounting bracket.

CAUTION

Be sure hood and all compartment doors are latched securely before driving vehicle

GASOLINE FUEL FILL

Removing the Fuel Cap

When removing the gasoline cap, slowly rotate it **only far enough to allow pressure to release**. After any "hissing" sounds stop, continue removing the cap.

Filling the Tank

Do not overfill the fuel tank. Allow gasoline to pump into the tank until the auto-shutoff valve in the fuel pump nozzle stops the flow of fuel, indicating a full tank. This provides a pre-determined vapor space at the top of the tank to allow for expansion of the gasoline.

CAUTION

Continuing to fill above this level may cause damage to the fuel/evaporative emission system.

Replacement Fuel Caps

To protect gasoline system from excessive pressure or vacuum, or from sudden pressure, replace lost caps with caps of the same design available from your Winnebago Industries dealer or a dealership that sells Chevy or Ford vehicles.

STARTING AND STOPPING ENGINE

Refer to your chassis operating guide for the manufacturer's recommendations on starting and stopping the engine.

Brake-Shift Interlock (Chevy and Ford Chassis)

Chevy and Ford chassis are equipped with a brake-shift interlock safety feature. The shift lever cannot be moved from the Park position unless the ignition is ON and the service brake pedal is pressed.

NOTE: On Ford chassis, if the brake light fuse is blown, the interlock feature will not work properly and an alternate method must be used. See your Ford Owners Guide for detailed instructions on what to do in this situation.

FUEL INFORMATION

Fuel Tank Capacity:

Chevy chassis.....	75 gal.
Ford chassis.....	75 gal.
Freightliner diesel chassis.....	90 gal.

FUEL SELECTION

Refer to your chassis operating guide for the manufacturer's recommendations on proper fuel selection.

WARNING

Modern fuel systems may build up pressure within the tank as the gasoline warms during use or in hot weather.

Under certain conditions, sudden release of this pressure when removing the gasoline cap can spray gasoline from the fuel fill opening, causing a possible hazard.

Fuel Pump Shut-Off Switch (Ford Chassis Only)

Vehicles built on Ford chassis are equipped with an inertial type switch that shuts off the fuel pump in the event of collision. This switch must be manually reset to resume the fuel supply to the engine.

See your Ford chassis operating guide for location and reset procedures for this switch.

NOTE: It is possible to accidentally trigger the fuel pump shut-off switch by abruptly striking an object such as a curb or parking block. If your vehicle exhibits symptoms of running out of fuel immediately after such an occurrence, the fuel pump shut-off switch may need to be reset. Consult your chassis operating guide for additional information.

FUEL SELECTION - FREIGHTLINER DIESEL CHASSIS

Refer to your Freightliner chassis operating guide for the manufacturer's recommendations on proper fuel selection.

Winter Fuel Waxing and Anti-Gel Additives

In sub-freezing temperatures, #2 diesel fuel can form small wax crystals that become trapped in the fuel filter and block the fuel flow to the engine, causing it to stall out. At sub-zero temperatures, the fuel can congeal and turn "slushy". If this happens, the only remedy is to have the vehicle towed into a heated facility to allow the fuel to warm up and become fully liquid again.

During winter time, most truck stops and reputable filling stations have winter blend diesel fuels available that are less susceptible to waxing.

There are also commercially available products, typically called anti-gel additives, to add to diesel fuel while filling the tank to inhibit wax formation in freezing temperatures.

Consult your Freightliner chassis guide or Cummins engine guide for more information on fuel requirements and additives.

Filling the Fuel Tank

Diesel fuel, especially #2 grade, can foam up while being pumped into the tank. Sometimes this foam can cause the pump nozzle to shut off before the tank is actually full. Allow the foam to settle then resume filling at a slower flow rate until the tank is full.

Fuel Tank Capacity: 90 gals. diesel

STARTING AND STOPPING DIESEL ENGINE

Refer to your Freightliner chassis operating guide for the manufacturer's recommendations on starting and stopping the engine.

See also "Engine Block Heater" in this section.

Cold Weather Starting: Please note the following cold weather starting precautions. This label is also located in appropriate areas of the coach. Failure to follow these precautions could cause serious damage to your diesel engine.

WARNING
DO NOT USE ETHER
OR STARTING FLUID

INTAKE MANIFOLD HEATER
MAY CAUSE EXPLOSION
AND SEVERE INJURY.

FREIGHTLINER DIESEL ENGINE BLOCK HEATER

Your coach is equipped with an engine block heater to assist starting in freezing temperatures. The heater is connected to both the shoreline and the auxiliary generator, so extension cords are not needed under most circumstances. The power switch is on the bedroom wall on the driver's side of the coach.

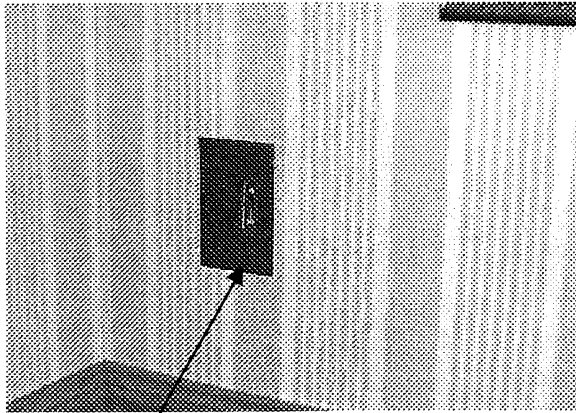

Engine Block Heater Switch
on forward left bedroom wall

To Use the Engine Heater

With the shoreline cord plugged into a shoreline hookup, turn on the engine heater power switch on the bedroom wall on the driver's side of the coach.

If a shoreline hookup is not available, just start the auxiliary generator to provide power to the engine heater.

REMEMBER! Turn the engine heater switch off after starting the engine. The heater will keep operating for as long as it is supplied with electricity. If the switch is left on, the engine heater will come on each time you hook up the shoreline cord or start the generator.

PARKING BRAKES

Chevy or Ford Chassis:

The parking brake pedal is located to the left of the foot service brake.

To set the parking brake, press the service brake pedal firmly with your right foot while you apply the parking brake with your left foot. The BRAKE warning light will go on as soon as you start to press the parking brake pedal. The brake will not prevent the vehicle from moving unless you push it down firmly and fully. Remove your foot from the service brake pedal and make sure there is no vehicle movement.

To release the parking brake, apply the service brake with your right foot and hold the parking brake pedal down with your left foot while you

pull the release lever. The release lever is located above the brake pedal.

NOTE: On some Chevy chassis the parking brakes are applied by pulling outward on the large diamond-shaped knob on the dash to the right of the steering column. Push the knob in to release the parking brakes.

Never drive your vehicle with the parking brake set as this will reduce parking brake effectiveness and cause excessive wear.

NOTE: Some Chevy chassis may have parking brakes that are applied by pulling outward on a large, diamond-shaped knob on the dash to the right of the steering column. Push the knob in to release the parking brakes.

Optional 16,500 lb. GVWR Chevy Chassis:

This chassis is equipped with an automatically applied parking brake that actuates when the shift lever is moved to the Park position.

Freightliner Diesel Chassis:

The parking brakes are applied by pulling outward on the large diamond-shaped knob on the dash to the right of the steering column. Push the knob in to release the brakes.

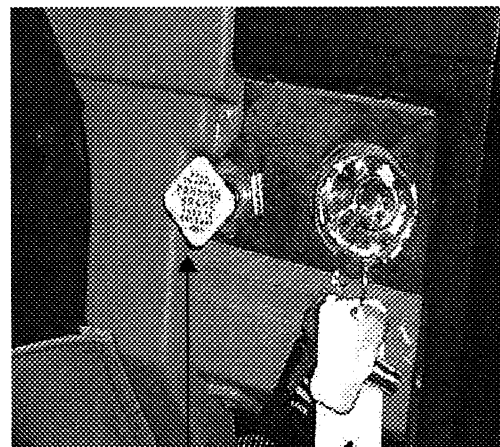

Parking Brake Knob

Use the parking brakes whenever the vehicle is parked. Never try to drive the vehicle with the park brake applied. This can cause excessive wear on the brakes and may damage the transmission.

ENGINE EXHAUST BRAKE

Model 36WL on Freightliner diesel chassis only

To Use the Exhaust Brake: The switch is located on the lower left side of the dash.

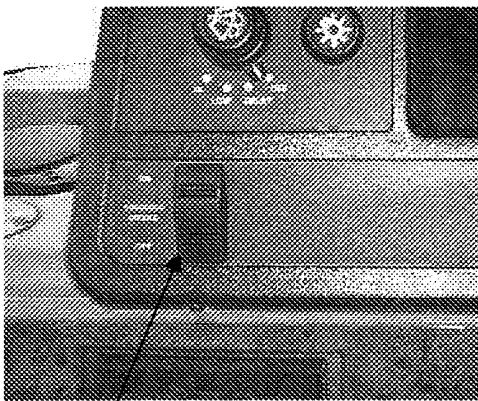

Exhaust Brake Switch

Press and release the ON side of the switch to activate the exhaust brake system. The exhaust brake will operate along with the regular chassis brakes whenever you press the brake pedal while the switch is ON. An indicator light near the switch will glow while the exhaust brake is activated.

Press and release the OFF side of the switch to deactivate the exhaust brake system and return to chassis brakes alone.

How It Works: The Jacobs® Extarder™ is an engine compression retarder that generates “braking” power by controlled restriction of the engine’s exhaust gas flow.

When the exhaust brake is activated, a valve closes off the engine’s exhaust causing the exhaust back pressure to increase, which causes the vehicle to slow down.

The increased back pressure would normally stop the engine except the forward momentum of

the vehicle keeps the drivetrain and the engine turning.

This controlled back pressure helps to regulate a vehicle’s downhill speed, such as on mountainous or hilly roads. It also provides “braking” on level or near-level roads.

For More Information: See your Jacobs® Extarder™ user guide in the blue binder for complete operating instructions and precautions.

ENTRANCE DOOR LOCK AND HANDLE

The entrance door may be opened by pulling the door handle outward. When the door is locked, neither the inside nor the outside door handle can be operated. It can be locked and unlocked from the outside of the vehicle by inserting the key into the lock and turning.

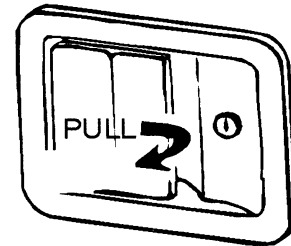

Entrance Door Handle - Outside

To lock the door from inside, rotate the lock levers as indicated. The deadbolt lock is for added security and should be used as a security night lock.

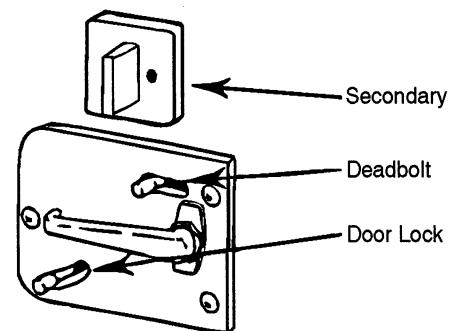

Entrance Door Handle - Inside

Lubricate the locks periodically with graphite to maintain good working condition.

CAUTION

When releasing security night lock, be sure to retract bolt before opening door latch to prevent drag on bolt pin. Instruct all passengers in operation of this door catch system as well as emergency exit window.

KEYS

Your motor home is supplied with several sets of keys. In addition to the chassis manufacturer's ignition key, you receive keys for front doors, entrance door, and exterior compartment doors.

Each set of keys has an identification number, either on a small metal tag or stamped into the key head. Record these numbers and keep them in a safe place. In case keys are lost or stolen, your dealer or a locksmith can provide you with duplicate keys or modify the locks.

NOTE: Keys should always be removed when leaving the vehicle. Since doors can be locked without keys, make sure they have been removed from the ignition before locking the driver's compartment.

ENTRANCE STEP - Powered

WARNING

Do not use steps unless they are fully extended.

Do Not Stand on electric entrance step when coach engine is being started. The step will automatically retract, which could cause personal injury.

The electric entrance step will extend automatically when you open the entrance door, and retract when you close the door. You can also switch the step power off if you want to keep the step extended while parked at a campsite, when you exit and enter the coach frequently. This saves wear on the step mechanism and conserves coach battery power.

The step power switch is located on the entry switch panel to the left of the doorway as you enter the coach. The step will extend when the door is opened even if the switch is off. The step will not retract, however, unless the switch is on.

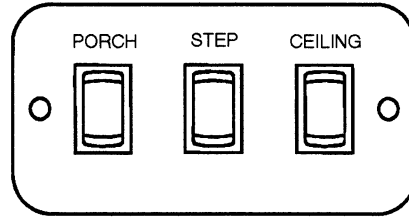

Entry Switch Panel

If the step will not extend or retract, check the step power switch.

This step has a unique safety retraction feature that prevents damage to the step by driving off with the step extended. Even if the step is extended with the step switch turned off and the entrance door closed, the step will automatically retract when the coach engine is started.

See the power step owner's manual in your Motor Home Operations Manual for operating instructions and additional information.

CAUTION

Always remember to retract the entrance steps before traveling or moving the vehicle.

LUGGAGE COMPARTMENT DOORS

To ensure that compartment doors have latched properly, press the bottom edge of the door with the palms of your hands.

This is more important for smaller and lighter compartment doors because when the door is "dropped" closed, the air trapped inside the compartment may create a cushioning effect that could prevent door latches from engaging properly.

SEATS

The driver and co-pilot seats may be independently adjusted to suit individual preference. To move the seat forward or backward, press the slide release button, located on the side of the

seat, and exert slight body pressure in the direction desired.

The seats may be swiveled to provide easy entrance and exit. The swivel feature also allows the seats on some models to be turned toward the living area for additional seating while the unit is parked.

To swivel the seats: Press the release button, located on the side of the seat, and rotate seat. The seats are designed to lock only when returned to the forward facing position.

NOTE: If your driver seat is equipped with power seat controls, the swivel release button is located beneath the seat on the right side of the seat.

To recline the seats: Lift the reclining lever, lean back to desired incline and release the lever. To return to the upright position, lift the lever and lean body forward. Allow the seat to return to the desired position and release the lever.

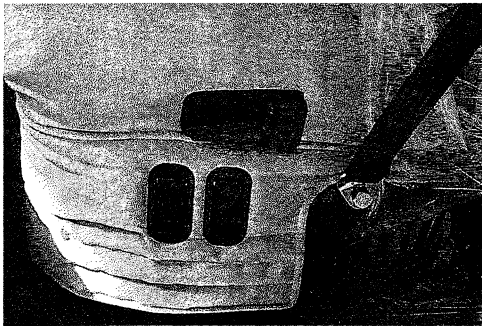

WARNING

Do not adjust driver's seat while vehicle is in motion.

After adjusting seat, always use body pressure to make sure slide and swivel locking mechanism have engaged.

6-Way Power Seat Controls

The power seat controls are located on the lower right hand side of the seat base.

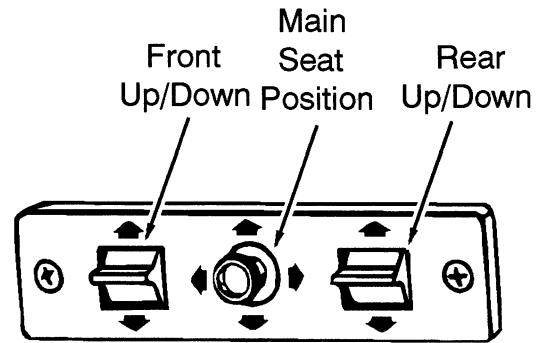

Power Seat Control

ARM REST ADJUSTMENT

The driver and co-pilot seat armrests may be adjusted to rest at two different positions as shown.

Position 1 - This is the normal default position of the armrest. If the armrest is in position 2, raise armrest, until it pops outward from the seat, and lower into position. This position would generally be used when the seat is in the upright position.

Position 2 - Raise armrest, push inward firmly toward seat, and lower into position. You may wish to use this position when you recline the seat.

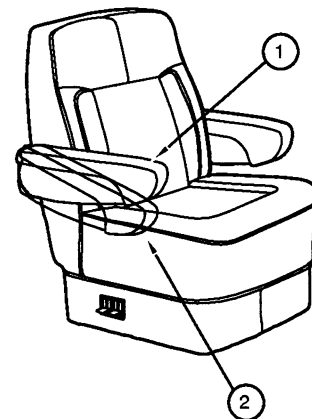

LOUNGE CHAIRS

Your coach may be furnished with one of the types of swivel/slider lounge chairs shown here.

The swivel feature will lock in the center facing position for your safety while the vehicle is moving.

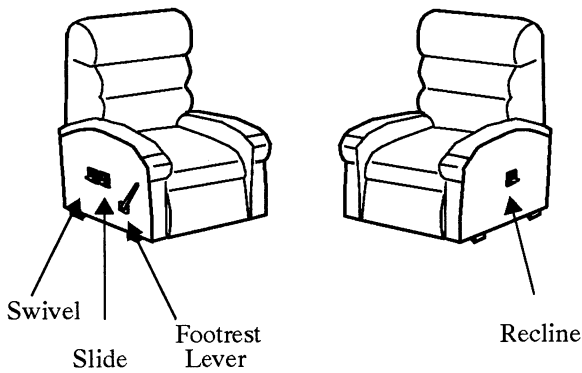

Swivel: Pull up on the swivel lever located on the side of the seat. The seat will lock into place whenever it reaches the center aisle facing position.

Always return the seat to the aisle facing position for proper use of seat belts while traveling.

Slide: Pull up on the slide lever located on the side of the seat. Slide to desired position and release lever.

SEAT BELTS

Seats intended for occupancy while the vehicle is in motion are equipped with seat belts for the protection of the driver and passengers.

Lap Belts

The lap belts must be worn as low as possible and fit snugly across the hip area. Always sit erect and well back into the seat. To gain full protection of the safety belt, never let more than one person use the same safety belt at any one time, and do not let the safety belts become damaged by pinching them in the doors or in the seat mechanism. After any serious accident, any seat belts which were in use at the time should be replaced.

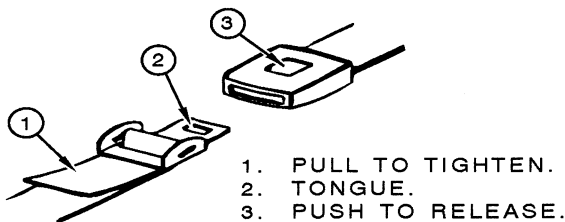

Adjustment: To lengthen belt, turn tongue at a right angle to belt and pull to desired length. To shorten, pull loose end of belt.

To Fasten: Be sure belt is not twisted. Grasp each part of the belt assembly and push tongue into buckle. Adjust to a snug fit by pulling the loose end away from the tongue.

To Release: Press button in center of buckle and slide tongue out of buckle.

WARNING

Snug and low belt positions are essential. This will ensure that the force exerted by the lap belt in a collision is spread over the strong hip area and not across the abdomen, which could result in serious injury.

Only seats equipped with seat belts are to be occupied while vehicle is in motion.

THREE-POINT LAP-SHOULDER BELTS

The driver and co-pilot seat belts in your coach are equipped with automatic locking retractors that let you easily adjust your seat belt to the proper length for passenger safety.

Fastening:

- Grasp the belt just behind the tongue using the hand nearest the door or sidewall. Be sure the belt is not twisted before fastening.
- Pull the belt smoothly outward from the wall and across your body, then insert the tongue into the buckle on the aisle side of the seat until it locks with a positive "click".

(NOTE: Do not pull the belt away from the wall too quickly or it will "lock" and prevent you from pulling it any farther. If this happens, relax your pull on the belt slightly then continue pulling it less quickly.)

- Feed any excess belt length back toward the wall so the belt retractor will lock the belt at the proper length for your body when released.

- The lap belt portion must be worn snug and low across the pelvic area.
- The shoulder strap portion must be worn diagonally across the chest and over the shoulder, but not against the neck.
- Seat belts offer optimum protection only when worn properly on the body and when the seat is in an upright position.

Unfastening:

- Press the release button in the buckle.
- Hold onto the tongue when you release it from the buckle to keep it from retracting too rapidly.

WARNING
Never wear the shoulder belt in any position other than as stated above. Failure to do so could increase the chance or extent of injury in a collision

CARE AND CLEANING

- Be careful not to damage the belt webbing and hardware. Take care not to pinch them in the seat or doors.
- Inspect the belts and hardware periodically. Check for cuts, frays, and loose parts. Damaged parts should be replaced. Do not remove or modify the belt system.
- Keep belts clean and dry. If the belts need cleaning, use only a mild soap and water solution. Do not use hot water. Do not use abrasive cleaners or bleach. These products may weaken or damage the belts.
- Replace any belt assembly that was used during a severe impact. Replace the complete assembly even if damage is not apparent.

CHILD RESTRAINTS

All 50 of the United States and the District of Columbia now require the use of the child/infant restraint systems for children in vehicles.

A properly installed and secured child restraint system can help reduce the chance or severity of personal injury to a child in an accident or during a sudden maneuver. Children may be injured in an accident if they are not seated in a child restraint which is not properly secured.

A child restraint system is designed to be secured in a vehicle seat by a lap belt or the lap belt portion of a lap-shoulder belt. According to accident statistics, children are also safer when properly restrained in rear seating positions than in front seating positions.

When purchasing a child restraint system:

1. Look for the label certifying that it meets all applicable U.S. Federal Motor Vehicle Safety Standards (FMVSS) or, in Canada, requirements of the Children's Car Seats and Harnesses Regulations (CCSHR).
2. Make sure that it will attach to your vehicle and restrain your child securely and conveniently so that you are able to install it correctly each time it is used.
3. Be certain that it is appropriate for the child's height, weight and development. The instructions and/or the regulation label attached to the restraint typically provides this information.
4. Review the instructions for installation and use of the restraint. Be sure that you understand them fully and can install the restraint properly and safely in your vehicle.

POWER ELECTRIC MIRRORS

Always adjust mirrors for maximum rear visibility before driving off. Make sure the seat is adjusted for proper vehicle control and that you are sitting back squarely into the seat.

The electric mirrors are adjusted using a multi-directional switch located on the instrument panel to the left of the steering wheel.

Mirror Adjustment Control Mirror Heat Switch

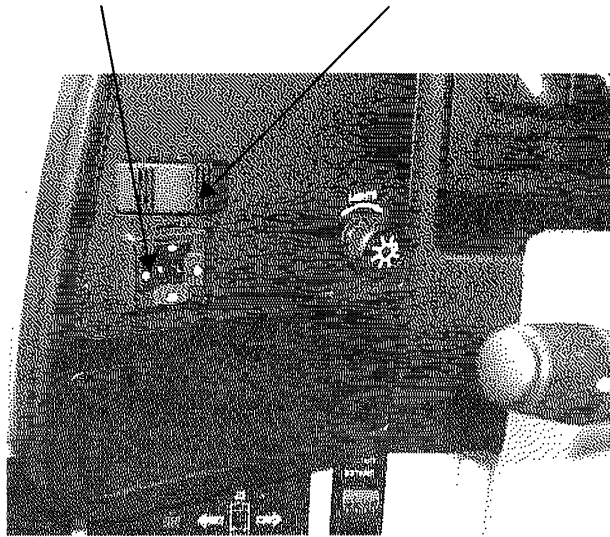

Select the mirror to be adjusted by pushing the switch in the middle of the control to the right or left. Then press the arrow buttons as necessary to obtain the best view.

When mirrors are adjusted to preference, place the selector switch back in the middle position to cancel power to the buttons. This prevents accidental misadjustment of mirror settings.

The mirrors also contain heating elements to defog or de-ice the mirror glass during cold weather operation. An ON-OFF switch for the mirror heaters is located near the remote mirror controls.

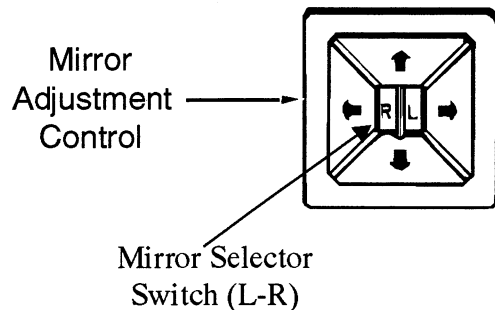

The power mirror control switch is intended for fine adjustment of the mirrors. If you cannot adjust a mirror properly using the control switch, it may need a coarse adjustment.

To do this, loosen the 2 set screws at the ball and socket base of the mirror. Adjust the mirror

to the proper viewing angle, then retighten the set screws. Fine adjustment can now be done with the control switch.

SONY REARVIEW TV MONITOR SYSTEM - Optional



If your motor home is equipped with this optional system, refer to the Motor Home Operation Manual binder for specific instructions provided by Sony.

INSTRUMENT PANEL GAUGES AND CONTROLS

The illustrations on the following page showing switches and features provided by Winnebago Industries.

See your chassis owner's manual for detailed information on the instrument gauges, steering column controls, brakes, and other chassis original equipment.

INSTRUMENT PANEL

- | | |
|---|--|
| 1. Park & Level Controls (n/a Freightliner) | 13. Rear Auto Heater Switch |
| 2. Power Mirror Adjustment Control | 14. Aux. Defrost Fan Switch |
| 3. Power Mirror Defrost Switch | 15. Jet Air Suspension (Low Air) Warning Light |
| 4. Headlight/Panel Light Switch* | 16. Leveling "Jacks Down" Warning Light |
| 5. Aux. Start Switch | 17. Cigarette Lighter/12V Socket |
| 6. Fog Light Switch | 18. Auto Heater/AC Controls |
| 7. Instrument Panel* | 19. Park Brake Knob (Freightliner and Opt. Chevy) |
| 8. Rear View (Backup) Monitor** | 20. Ignition Switch (Freightliner) |
| 9. Radio/Cassette or CD Player | 21. Slide-Out Room Switch |
| 10. Aux. Generator Start Switch | 22. Leveling Jack Control Pad (Jack Levers on Floor) |
| 11. Aux. Battery Switch | 23. Engine Exhaust Brake Switch (Freightliner) |
| 12. Radio Power Switch | 24. Windshield Wash/Wipe Switch (Freightliner) |

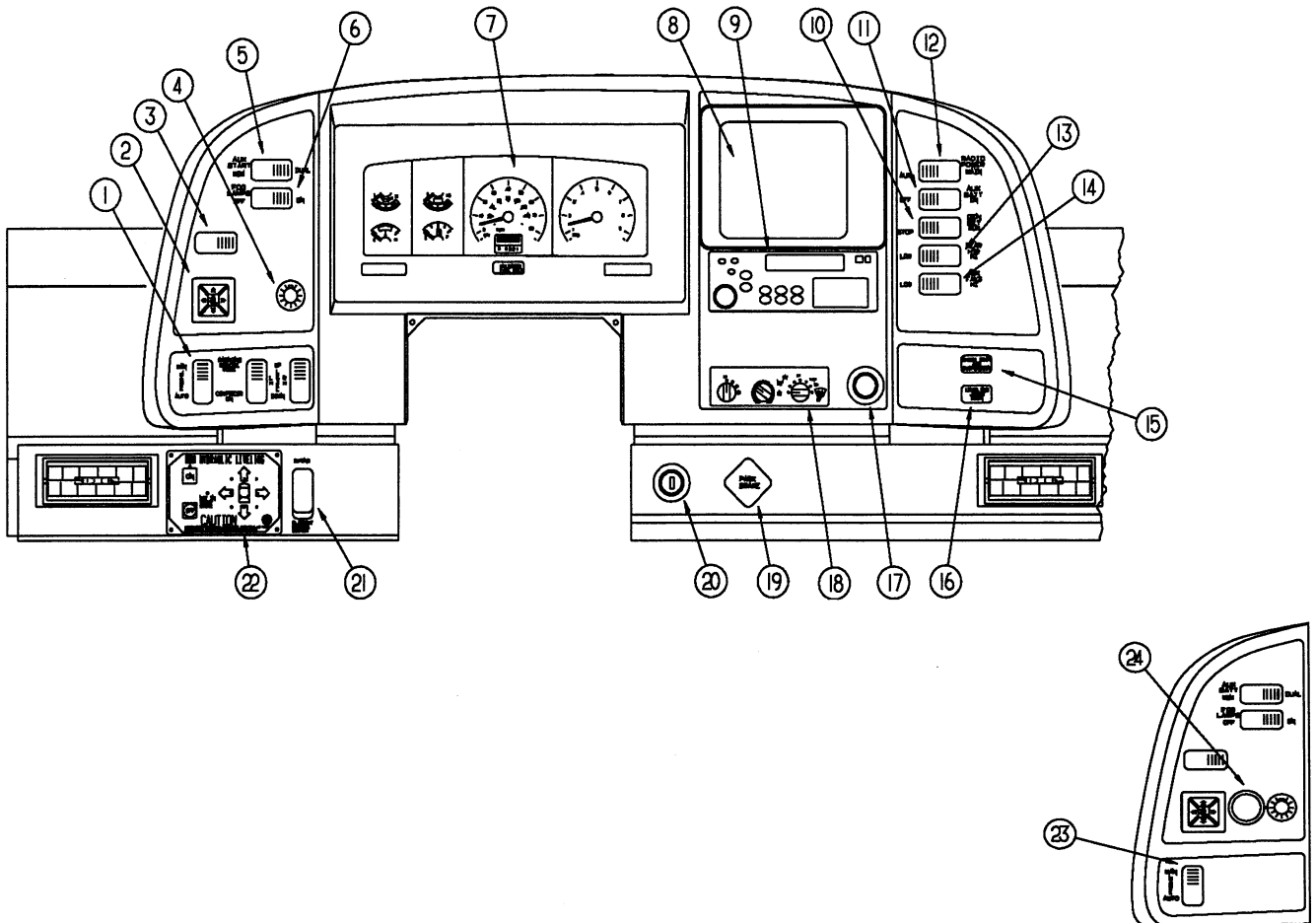

* See your Chevy, Ford or Freightliner chassis operating guide.

**If not equipped with monitor system, this space contains 6-tape cassette storage caddy.

NOTE: Some equipment or controls shown may be optional or unavailable on your model.

Ford instruments shown for illustration purpose only.

MULTI-FUNCTION SIGNAL LEVER

The multi-function signal lever controls the turn signals, high/low beam changing, windshield washer, wipers and wiper delay, and the electronic speed control (cruise) on some models.

See your chassis operating guide for complete operating information.

HEADLIGHT BEAM CHANGE AND TURN SIGNALS

Move multi-function lever upward for right turn signal and downward for left turn signal.

Pull end of handle toward you to switch high beam to low, or low beam to high.

WINDSHIELD WIPERS AND WIPER DELAY

See your chassis operating guide for complete operating information.

WINDSHIELD WASH/WIPE SWITCH (Freightliner Chassis)

Wash: Press the control knob to pump washer solution onto the windshield. The wiper will also begin operating. The wiper will continue for 5 wipes after you release the washer knob.

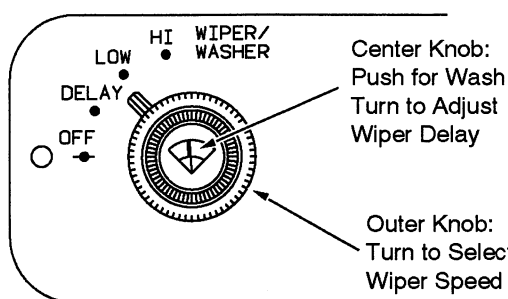

Wiper: Rotate the outer knob pointer to the desired setting - Delay, Low or Hi.

Delay: Turn the outer knob pointer to "Delay". Turn the center (wash) knob to set the time you want between wipes, from 1 second (all the way left) to about 90 seconds (all the way right).

HAZARD WARNING LIGHTS

See chassis manual or "Instrument Panels" in this section for location of hazard flasher switch.

See also Section 3 for further operating information.

CRUISE CONTROL

The electronic speed control (cruise) allows you to maintain a steady speed and relieve driving strain while traveling long distances.

See your chassis operator manual for complete instructions and precautions on the cruise control.

WARNING

Do not operate the cruise control on icy or extremely wet roads, winding roads, in heavy traffic, or in any other traffic situation where a constant speed cannot be maintained.

COMFORT CONTROLS

Auto Air Conditioner/Heater

Controls for the air conditioner, heater, defroster and vent are all combined into one control panel. Refer to the following instructions for use of individual controls.

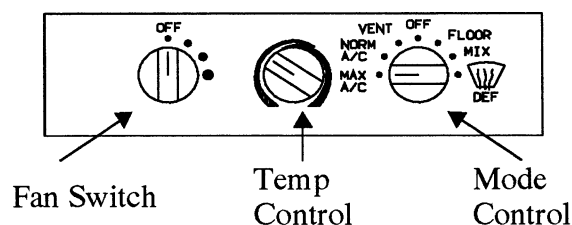

1. Front Heater Fan Switch
2. Temperature Control Knob
3. Mode Selection Knob

Heating

A. For maximum heating

1. Turn the mode selection knob HEAT or VENT.
2. Turn the temperature control knob to WARM (red).
3. Place the fan switch to high (largest dot).

B. For reduced heating:

1. Turn the temperature control knob to the left to an intermediate setting.

SECTION 2

DRIVING YOUR MOTOR HOME

Sunflyer

whether the dash radio or the TV and VCR for theater surround sound listening.

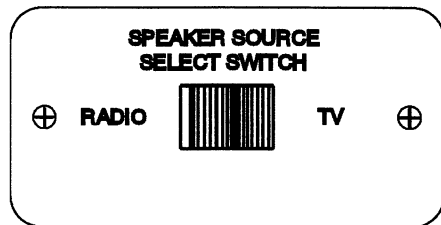
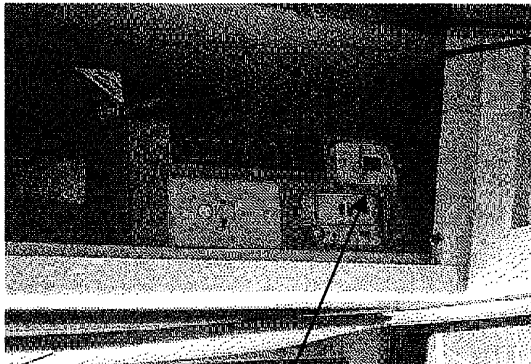

Compact Disc Changer (Optional)

The remote CD changer is located out of sight in the overhead cabinet above the driver's compartment. The changer cartridge holds up to 6 compact discs for several hours of listening enjoyment.

The controls are incorporated into the dash radio. See the Compact Disc Changer System operating guide in your motor home operations manual binder for complete operating instructions and basic troubleshooting.

AUX. START SWITCH

This switch can be used to provide emergency starting power from the motor home auxiliary battery if the automotive battery is dead.

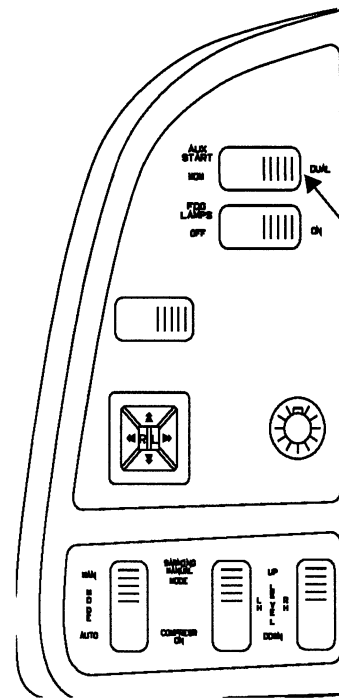

If engine battery is dead, press while turning ignition key for emergency starting power

AUXILIARY BATTERY (Aux. Batt) SWITCH

The AUX BATT switch disconnects the auxiliary (coach) batteries from the 12-volt system of your coach to avoid long-term battery drain by electrical items that are hooked directly to the coach batteries.

Always leave this switch ON except during long storage periods (a month or more).

CB RADIO WIRING (Optional)

If your coach is pre-wired for CB radio installation, the wires are located beneath the dash to the left of the steering wheel.

Look for a pair of wires, purple (+) and green (-), with connectors and flag labels, suspended from the wiring harness.

Be sure to read the wire labels before installing a CB radio. The labels contain important information and cautions.

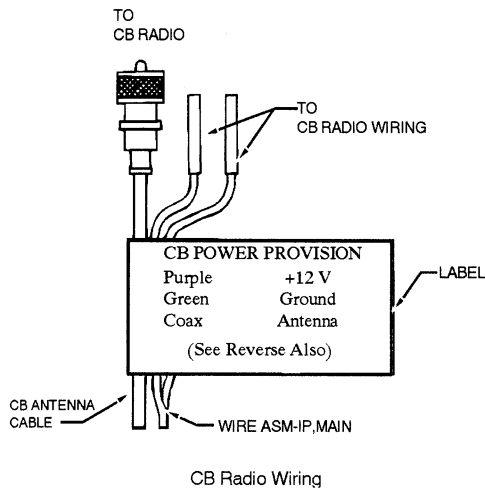

SWR ADJUSTMENT

To adjust CB antenna SWR (standing wave ratio), turn the adjusting ring of the antenna to achieve the lowest SWR reading. This procedure will help optimize transmitting and receiving capabilities of the radio system.

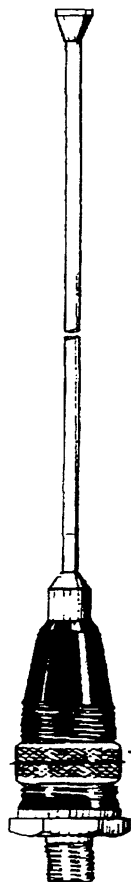

TO ADJUST:

CHECK SWR. ON
CH. 1 & CH. 40.
IF CH. 1 IS
**HIGHER THAN CH.
40** TURN TUNING
RING **CLOCKWISE.**
IF CH. 40 IS
**HIGHER THAN CH.
1** TURN TUNING
RING **COUNTER-
CLOCKWISE.**
USUALLY $\frac{1}{4}$ - $\frac{1}{2}$
TURN IS ENOUGH.
REPEAT UNTIL
CH. 1 & 40 ARE
THE SAME.
**DO NOT TRIM
WHIP.**

CAUTION

The CB radio could become damaged if CB antenna SWR is not adjusted before operating CB radio.

COACH LEVELING SYSTEMS

Your coach is equipped with a HWH® hydraulic leveling system.

This leveling system is designed to diminish problems in selecting a parking site, making "set up" easier and faster for you.

See the HWH Operator Manual in your Motor Home Operations Manual binder for complete operating instructions. It also contains additional precautions, technical information, and instructions for manual operation if automatic functions fail.

The leveling system control panel is located on the lower left dash panel.

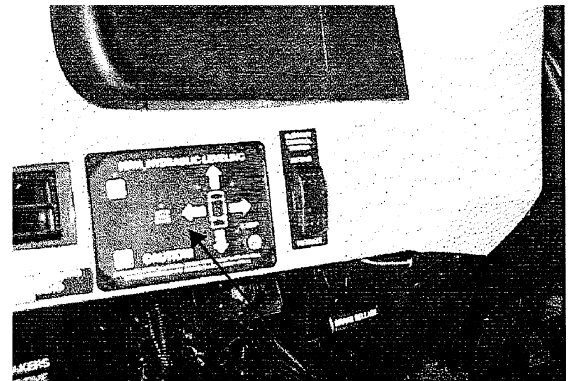

Automatic Leveling System
Control Panel

NOTE: When parking at an uneven site, always park the front of the motor home to the downhill side. This allows you to level by raising the front end rather than the rear. Since only the rear wheels are locked while in PARK, raising the rear wheels off the ground could allow the vehicle to roll off the jacks.

CAUTION

Do not try to drive vehicle unless 'TRAVEL' light is glowing with ignition switch on.

Do not try to drive the vehicle until the air suspension system has built up sufficient pressure if you have used the coach leveling system or have used the DUMP button to manually exhaust the air suspension system.

WARNING

Keep all people clear of the coach while the leveling system is operating.

Do not use leveling jacks to support vehicle for service or tire changing.

JET AIR RIDE™ PARK & LEVEL™ SYSTEM - Optional

(Not available on Freightliner Chassis)

Operating Instructions

Normal Driving Mode

The mode switch should be placed in the "Auto" position before driving off. A red warning light will alert you when the system is in the Park & Level™ (Manual) mode.

CAUTION

Do not drive the vehicle with the Auto/Manual position. Damage to suspension components could result.

NOTE: Automatic leveling is deactivated when the ignition is switched off, so the coach may appear "jacked up" in the rear under certain circumstances. This is not a malfunction and should be no cause for alarm. When the vehicle is restarted, the automatic leveling system will immediately correct this situation.

Park & Level™ System

The Park & Level system incorporates electronic air distribution controls for vehicle leveling purposes. It allows air spring pressure to be manually adjusted up-and-down or side-to-side to simulate the function of a hydraulic leveling system. This provides the vehicle owner with a reasonable degree of flexibility in parking/camping site selection.

Park & Level™ Controls

The Park & Level control panel is located at the lower left-hand side of the dash. It contains 3 rocker switches, a compressor indicator light; and a manual mode warning light.

Leveling

Press the mode switch to "Manual". A red warning light will illuminate to indicate that the leveling feature is activated. Level the vehicle by operating the level switches.

- When raising the rear of the vehicle, operate both springs at the same time to provide maximum lifting power.
- When parked on a side hill, raise both springs as mentioned above, then lower the spring on the "uphill" side until the vehicle is level.
- When you're ready to drive off, switch the mode to "Automatic" and wait until the springs automatically adjust for road travel.

NOTE: The air bags will inflate and deflate slightly about 5 to 8 times until the coach is leveled.

Compressor Light

The green indicator light labeled "Compressor On" will illuminate only while the compressor is operating. When air pressure depletes to a preset minimum amount, the compressor will operate until maximum pressure is restored.

It is normal for the compressor to operate periodically while driving to maintain air pressure in the system. It will also operate for a few minutes after starting the vehicle and switching the Auto/Manual switch back to "Auto" (when Park

& Level™ has been in use) to restore air pressure released during leveling.

Air Suspension Warning Light

CAUTION

The rear air suspension warning light, located on the lower instrument panel to the right of the steering column, will illuminate if a failure should occur in the rear axle/rear suspension system. If this should occur while driving, the vehicle may be carefully driven to the nearest Winnebago or Itasca dealer or a qualified truck air suspension service center. Although this condition does not totally disable the vehicle, it will cause less than satisfactory ride characteristics and should be serviced as soon as possible to restore proper performance.

System Fuse

If the Jet Air Ride system fails to operate, check the 30A plug-in fuse located on automotive circuit breaker/fuse panel on the firewall below the left side of the dash. Turn twist lock to the left to remove protective cover. Pull cover outward and up to remove.

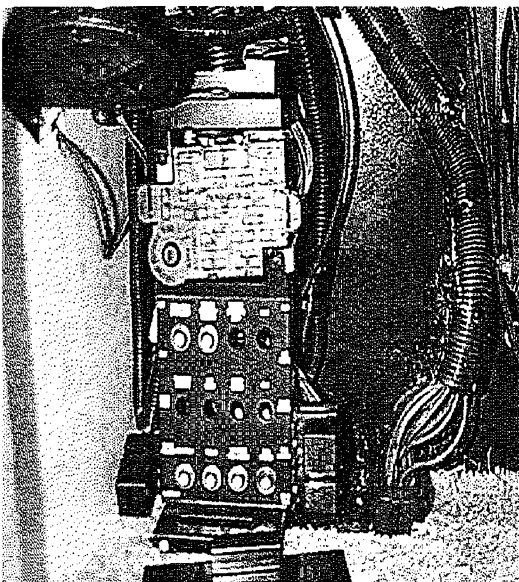

Automotive Circuit Breakers & Fuses
(Beneath left side of dash)

Always replace fuse with one of equal size and amperage rating.

Periodic Maintenance

See page 9-6.

SLIDE-OUT ROOM EXTENSION

CAUTION

Release slide-out room travel latches before attempting to extend slide-out room. Fasten travel latches before driving vehicle. See instructions below.

The slide-out room extension provides a spacious living area at the push of a button. The slide-out room is extended and retracted using a hydraulic mechanism with an electronic control system. The slide-out control switch is located on the lower left dash area.

Travel Latches

The Travel Latches **must be released before attempting to extend the room** or damage to the coach will result.

The travel latches are designed only to help keep the room extension secured against the coach sidewall to maintain an effective weather seal while the vehicle is in motion. They are not designed to withstand the force exerted by the hydraulic extension mechanism and will not prevent accidental extension of the room.

The travel latches are located at the bottom edges of the slide-out room side walls.

To Release:

- Pull the latch handle outward and down.
- Lift the black metal D-ring and push the J-hook back to disengage.
- Push the D-ring down to the floor and lift the latch handle upward against the wall.
- Repeat for other side of room.

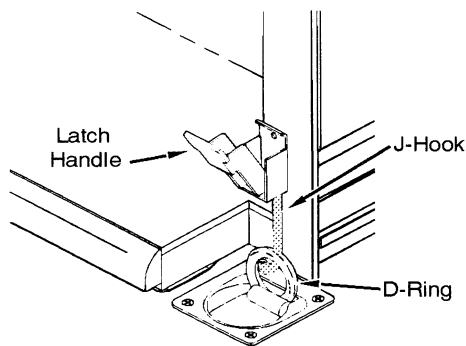

Travel Latches

To Fasten:

- Pull the latch handle outward and down.
- Lift the black metal D-ring up and engage the J-hook.
- Lift the latch handle upward and lock against the wall.
- Repeat for other side of room.

NOTE: If latches become loose and will not stay fastened, see your dealer for proper adjustment.

WARNING

Keep all persons clear of the slide-out room and moving parts while extending or retracting. Do not occupy the slide-out room while it is being extended or retracted.

To Extend Slide-Out Living Room:

- Level the coach.
- Leave leveling system on to provide power to the slide-out mechanism.
- Turn the ignition switch to ON or ACC and set the Parking Brake. An interlock relay system will then provide power to the slide-out control switch.
- Release travel latches.
- Press slide-out switch and hold until room is fully extended, then release switch.

Before Retracting Slide-Out Room

If it has rained recently before you retract the slide-out room, we recommend using the hydraulic leveling system to lean the coach and drain off any excess water possibly remaining on the roof before retracting. Lean the coach slightly to the left (driver's side) as shown by raising both right side jacks to let excess water flow away from the rooftop weatherseal and toward the outside of the slide-out roof.

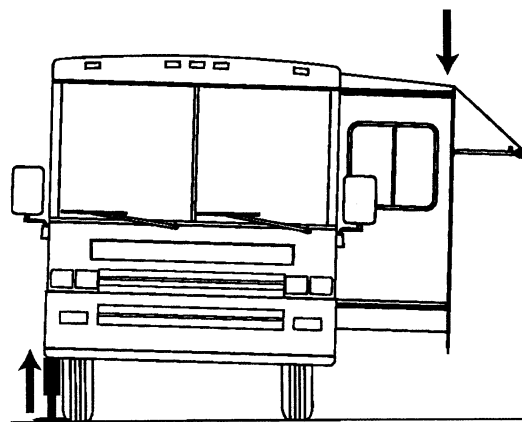

To Retract Slide-Out Room:

CAUTION

Although there is an awning over the roof of the slide-out room, there is a possibility of debris getting onto the roof. Because the slide-out roof is drawn into the interior of the coach when retracted, be sure there is no debris, such as excessive dirt, tree seeds, twigs, leaves, etc. on the roof before retracting.

- Remove all items from the coach living room floor. Turn leveling system on to provide power to the slide-out control switch.
- Press slide-out switch and hold until room is fully retracted, then release the switch.

High Wind Precaution

We remind you to be aware of high winds while the room is extended because of the effect they can have on the roof awning. It is a good idea to retract the room any time high wind con-

ditions exist that would also make it necessary to roll in the patio side awning. This will protect the slide-out room awning from possible wind damage.

If Slide-Out Room Will Not Operate (Troubleshooting)

- The chassis battery may be low on charge. Press the Aux. Start switch on the dash to the momentary (MOM) position while pressing the slide-out control switch. This momentarily connects the coach batteries to assist in retracting the room.
- One of the fuses may be blown. Fuses are located on the interior firewall beneath the dash, beneath the instrument panel dash pod, and inside the leveling control pad housing.
- If the batteries and fuses are okay, there may be a failure in the hydraulic system or electrical system. See “Manual Retracting Instructions” for help.

Slide-Out Room Extension Emergency Crank-In Procedure - (Use only when room will not retract using control switch)

If a failure occurs in the slide-out electrical or hydraulic systems, and the room will not retract using the control switch, you can manually crank the room in using an emergency winch system described below. The winch is generally stored beneath the dinette seat or in a cargo compartment on the passenger side of the coach.

Step 1 - Relieve Hydraulic Line Pressure

- Open the hydraulic pump valves to release hydraulic line pressure and let fluid bypass into the fluid reservoir. The pump is located beneath the coach, below the furnace and to the rear of the second storage compartment on the driver side of the vehicle. The valves can be reached best by lying on your back and reaching up between the mounting brackets.

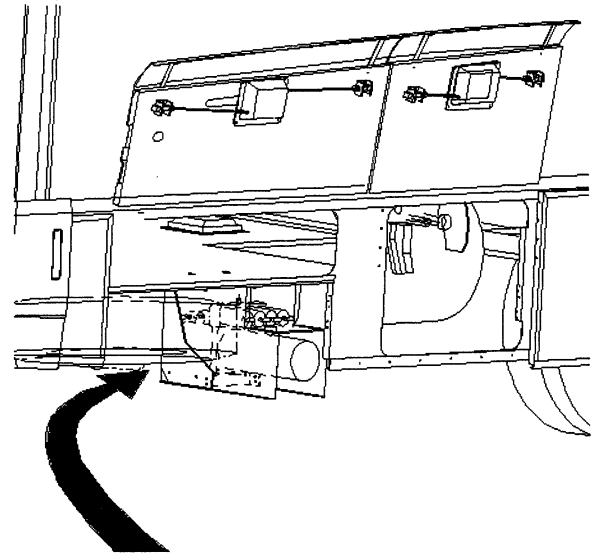

Slide-Out Room Hydraulic Pump

WARNING

Stop engine, place transmission in park position and apply parking brake before lying beneath vehicle for this procedure.

- Open the 2 T-handle valves on the inside end of the pump only. Turn T-handles counter-clockwise to open.

DO NOT OPEN ANY OF THE 4 VALVES ON THE OUTSIDE END OF THE PUMP because they regulate the leveling jacks.

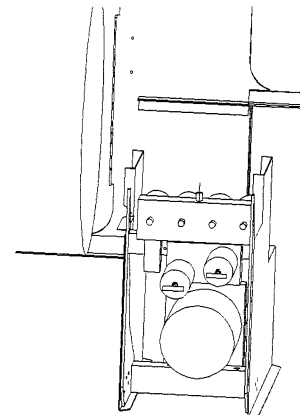

Hydraulic Pressure Release (T-handle) Valves - viewed from center of vehicle

SECTION 2

DRIVING YOUR MOTOR HOME

Sunflyer

NOTE: The T-handles may turn easily at first but will become more difficult to turn as internal springs are compressed. Be sure to open both valves completely (about 6 turns of each T-handle).

Step 2 - Attach Winch and Crank Room Inward

- Remove the register from the floor heat duct and anchor the winch in the floor. Insert the winch retainer bracket into the duct cutout in the floor as shown.

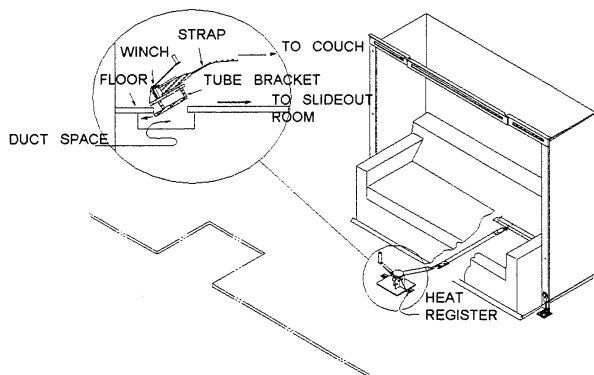

NOTE: Be sure the bracket extensions face away from the slideout room as shown for proper support while cranking.

- Insert the winch strap hook into the sewn loop end of the strap beneath the couch.
- Be sure the winch ratchet pawl is in the locking position (against the gear teeth) before cranking.
- Crank the winch handle clockwise slowly, a few “clicks” at a time, until the room is fully retracted. **Allow about 10 minutes to crank room in fully.**

NOTE: Attempting to crank the room in too quickly will raise pressure in the hydraulic fluid lines and make cranking more difficult.

- Unhook the winch and return the winch and straps to storage locations. Release the strap by putting slight pressure clockwise on the crank handle, then moving the ratchet pawl to the free-wheel position (away from gear teeth).

Step 3 - Secure Travel Latches and Close Hydraulic Line Valves

- Fasten the slide-out room Travel Latches as shown.

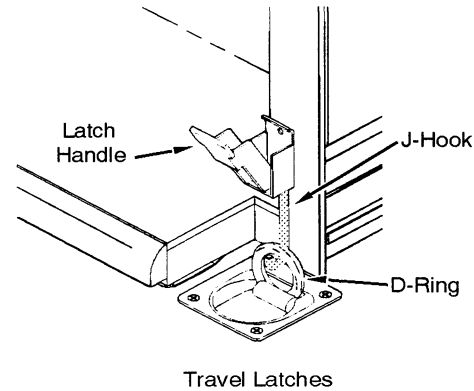

- Close the hydraulic pump valve T-handles completely.

NOTE: Close the valves snugly, but do not overtighten. Overtightening may cause internal damage to the valves.

- See your dealer for service of the room extension system before using again.

Further Information

See the HWH Hydraulic Room Extension operating guide included in your operation manual binder for further instructions and troubleshooting information.

HAZARD WARNING FLASHER

The hazard warning flasher provides additional safety when the vehicle must be stopped on the side of the roadway and presents a possible hazard to other motorists. When the flasher is on, it serves as a warning to the other drivers to approach and overtake your vehicle with caution.

WARNING

Operating the hazard warning flasher system while moving on the highway is illegal.

The front and rear turn signals will flash intermittently when the flashers are in operation. When it is necessary to leave the vehicle, the flasher system will continue to operate with the ignition key removed.

See your Chevy, Ford or Freightliner chassis operator's guide for information on operating the hazard warning flashers.

IF YOU GET A FLAT TIRE

In case of sudden tire failure, avoid heavy brake application. Gradually decrease speed. Hold steering wheel firmly and move slowly to a safe, off-road place. Park on a level spot, turn off the ignition, and turn on the hazard warning flasher system.

SPARE TIRE STORAGE

The spare tire is mounted on a cable hoist assembly beneath the rear of the vehicle.

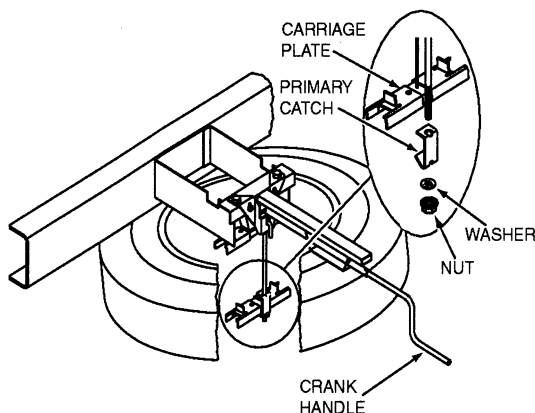

NOTE: On Freightliner diesel chassis the spare tire hoist is in the right rear. Insert the crank through the side after opening right rear compartment door.

To Access Spare:

1. Remove the primary latch bracket from the tire hoist assembly. To do this unscrew the wing nut and remove the bracket from the lower side of the carriage plate at the center of the wheel as shown.

CAUTION

Be sure hoist is tight before loosening primary latch. Tire could be free to drop if hoist is not tightened fully.

2. Insert the crank handle through the hole in the bumper. Be sure the pins on the crank handle engage with the slots in the hoist shaft.
3. Turn the crank handle counter-clockwise to lower the tire to the ground.
4. Remove the spare from the carriage plate by passing the plate through the large center hole of the wheel.

To Stow Spare:

1. Insert the carriage plate through the wheel and align so the retainers will engage into the center hole of the wheel.
2. Insert the crank handle into the bumper and crank clockwise to pull the tire up. Check to see that the carriage plate is firmly engaged in the center hole of the wheel as the cable becomes taut.
3. When the tire makes snug contact with the frame, crank the handle until a crisp break is heard and felt. Crank until a second crisp break occurs. This assures the hoist mechanism has reached its maximum stowing force. Remove and stow the crank handle.
4. Slide the primary latch bracket back onto the bolt. Be sure the lower hook-lip engages onto the lip on the underside of the carriage

plate, then place the washer and nut onto the bolt and tighten securely.

MOTOR HOME JACKING AND TIRE CHANGING

WARNING

We advise you to obtain qualified road service whenever possible. Do not try to change a tire yourself except under emergency conditions, and only by closely following instructions in this manual and the chassis operating guide.

If you do satisfactorily complete an emergency tire change, we recommend that you have the wheel nuts checked and properly torque tightened by qualified service personnel as soon as possible.

After a wheel has been properly torqued and inspected by qualified service personnel, it should be rechecked after traveling 100 miles, then again at each oil change.

NOTE: The jack referred to in the following instructions is not supplied with the vehicle. You can obtain one from your dealer.

A jack is designed for use as a tool for changing tires only, not for use as a leveling device or as a support when servicing.

WARNING

Tire change procedures should be used in emergency situations only. The operator is advised to obtain qualified road service when possible.

SAFETY PRECAUTIONS

Before trying to change either the front or rear tires, follow these precautions:

1. Park vehicle on level surface only.
2. Turn off engine and set parking brake.

3. Turn on hazard warning flasher.
4. Block both front and back of tire on opposite side of vehicle from wheel to be removed.
5. On soft ground, use a board or other material under jack as a firm base to ensure that the jack will not shift.

JACKING POINTS ON VEHICLE

Chevy: Front-under lower control arm; Rear-under axle.

Ford or Freightliner: See your chassis manual for specified jacking points.

FRONT WHEEL

Before trying to remove the front wheel, observe the above safety precautions, then follow the procedure below:

1. Place jack under jacking point specified by chassis manufacturer. See *Jacking Points* above. Position jack so it may be operated without placing your body beneath vehicle.
2. Screw jack extension pad out (up) until it touches jacking point surface.
3. Begin jacking until jack is firmly positioned and just begins to bear weight, but **do not** lift tire off the ground.
4. "Crack" wheel nuts loose with lug wrench, but do not unscrew nuts yet.
5. Resume jacking until wheel is free of ground.
6. Remove wheel nuts and wheel; put spare wheel in place.
7. Install wheel nuts and tighten as much as possible with wheel and tire off the ground.
8. Lower tire until tire just contacts the ground. Tighten nuts with lug wrench in sequence recommended by chassis manufacturer.
9. Finish lowering jack, then remove jack and blocks.

WARNING

Upon satisfactory completion of emergency tire change, it is highly recommended that wheel nuts be properly torqued and inspected by qualified service personnel as soon as possible.

DUAL REAR WHEELS

Before trying to remove the rear wheel, follow safety precautions in the beginning of the motor home jacking procedures. Then follow the procedure below:

1. Place jack under jacking point specified by chassis manufacturer. See *Jacking Points* on previous page. Position jack so it may be operated without placing your body beneath vehicle.
2. Screw jack extension pad out (up) until it touches jacking point surface.
3. Begin jacking until jack is firmly positioned and just begins to bear weight, but **do not** lift tire off the ground.
4. "Crack" wheel nuts loose with lug wrench, but do not unscrew nuts yet.
5. Resume jacking until wheel and tire are free of ground.

WARNING

DO NOT crawl under the vehicle when it is supported by a jack.

6. Remove wheel nuts and wheel.

NOTE: When installing the outer dual wheel and tire assembly, rotate the outer dual wheel so valve stems are accessible but not touching one another. In some cases this means that the inner and outer valve stems should be in separate wheel cutout locations

NOTE: When installing or tightening dual wheels, both wheels on the same side must be off the ground (not resting on the inner dual). This minimizes the possibility of loose wheels after correct mounting torque is applied.

7. Mount spare wheel on studs and replace wheel nuts. Refer to your chassis operating guide for wheel nut torque and tightening sequence.

WHEEL NUTS

To properly seat the wheel nuts and to eliminate the possibility of the wheel nuts becoming loosened while driving, they should be tightened at frequent intervals to the torque specified in your chassis operating guide. This is especially important after the first 100, 1,000 and 6,000 miles of operation after replacement of a wheel or wheel nuts.

RECOVERY TOWING

When calling a professional towing service, we recommend that you advise them of your coach length and approximate front axle weight. This will allow the towing operator to determine the proper towing equipment to use. (This information is found on the vehicle certification label located to the left of the steering wheel.)

We recommend that you ask for an underlift (wheel lift or frame lift) type towing assembly for safe towing.

Winnebago Industries does not assume responsibility for damage incurred while towing this vehicle.

NOTE: Consult the chassis operating guide for any additional towing instructions or precautions provided by the chassis manufacturer.

CAUTION

Do not lift on bumper. Damage will result to front end body parts.

WARNING

Stay out from beneath the motor home while it is suspended by the towing assembly unless the vehicle is adequately supported by safety stands. Do not allow passengers to occupy a towed vehicle.

NOTE: Know and obey all state and local towing regulations. Tow at reduced speed.

JUMP STARTING

WARNING

Automotive batteries produce caustic acid, explosive gases, and electrical current which may cause burns. It is important that the instructions below are followed **exactly**, or personal injury (particularly to eyes) or property damage may result due to battery explosion, battery acid, or electrical (short circuit) burns.

- NEVER smoke near the battery or expose it to open flame or electrical sparks.
- Wear eye protection or shield your eyes while working near battery, in case an explosion does occur. NEVER lean over a battery.
- Do not allow battery fluid to contact eyes, skin, clothing, or painted surfaces. Immediately flush any contacted area with water. If eyes are affected, seek medical help after flushing.
- Remove all metal jewelry to lessen the risk of a short circuit occurring.

CONNECTING JUMPER CABLES

1. Make sure that the other vehicle has a 12-volt battery and negative ground compatible with your vehicle's electrical system.
2. Position the vehicle with the good battery so that the jumper cables will reach, but **do not allow the vehicles to touch**.
3. Turn off all electrical accessories, motors, and lights except those needed for safety or to light up the work area. Place automatic transmission in P (Park). Be sure parking brakes are engaged in both vehicles.
4. If the weak battery has filler caps, make sure the electrolyte is at proper level. Add distilled water if fluid is low. If electrolyte is not visible or appears to be frozen - **do not attempt jump starting!** A battery may rup-

ture or explode if the electrolyte is frozen or not filled to the proper level.

5. Connect one end of the positive "+" (red) jumper cable to the positive "+" terminal of the weak battery. Connect the other end to the positive "+" terminal of the charged battery.
6. Connect one end of the negative "-" (black) jumper cable to the negative "-" terminal of the charged battery.
7. Finally, connect the remaining end of the negative "-" (black) cable to a solid, metal grounded location on the engine of the vehicle with the weak battery, at a point at least 18 inches from the battery. Do not connect to any moving parts. **THE MAIN SAFETY PRECAUTION IS TO MAKE THE FINAL GROUND CONNECTION ON THE ENGINE AT A SAFE DISTANCE FROM THE BATTERY. THIS HELPS TO REDUCE THE CHANCE OF EXPLOSION DUE TO SPARKS.**
8. Start the engine of the vehicle with the charged battery, and allow it to run for a few minutes at moderate r.p.m. Then start the engine of the vehicle with the discharged battery.
9. Reverse the above sequence **EXACTLY** when removing the jumper cables. Start by removing the cable from the ground location on the engine first, then continue in reverse sequence.

WARNING

Do not attempt to push-start this vehicle. Damage to the transmission or other parts of the vehicle could occur.

CONNECTING A BATTERY CHARGER

To connect a battery charger, first make sure the engine is switched off. Disconnect the positive (+) lead from the battery. Never disconnect the battery while the engine is running or alternator damage could result.

Connect the positive "+" (red) lead of the charger to the positive "+" terminal on the

battery. Next, connect the negative “-” (black) lead of the charger to a suitable ground. Finally, plug in or switch on the charger.

To disconnect the charger after charging, unplug the charger from the electrical outlets, remove the charger leads from the vehicle, and reconnect the vehicle leads to the battery.

ENGINE OVERHEAT

WARNING

Operating a vehicle under a severe overheating condition can result in damage to the vehicle and may result in personal injury.

An engine will overheat if the coolant is low or there is a loss of coolant because of one or more of the following:

- a leak in the cooling system
- a hose failure
- a drive belt breaking
- water pump failure

Also, be aware of the following situations, which can cause temporary engine overheating:

- climbing a long hill on a hot day
- idling while stopped in traffic for long periods of time
- towing a trailer or automobile
- stopping after a period of high speed driving

If the TEMP indicator on the instrument panel shows a rise in engine coolant temperature while driving, take the following steps to attempt to lower the overheating condition:

- If you are using the automotive air conditioner, turn it off.
- If you are stopped in traffic, shift the transmission into P (Park), and engage parking brake.

If the temperature does not drop within a minute or two:

- Pull the vehicle over to the roadside as soon as it is safe to do so.
- Place the transmission in P (Park) and press the accelerator to increase engine speed (r.p.m.'s) to twice that of normal idle speed,

and hold it there for approximately two or three minutes.

- If engine temperature does not go down, turn the engine off and wait until the engine has cooled before attempting to open the hood.

If you see or hear steam escaping from the radiator or the engine compartment or have any other reason to suspect an extreme engine overheating condition, pull the vehicle over to the roadside as soon as it is safe to do so, stop the engine and get out of the vehicle.

When no trace of escaping steam is heard or seen, open the hood to check for the cause of the overheat. Check hose connections and tighten if necessary. Make sure there are no broken belts, pulleys or hoses before adding any coolant to the radiator.

For further information in case of overheating, consult your chassis operating guide.

(See also SAFETY PRECAUTIONS, Section 1 of this manual.)

LOADING THE VEHICLE

When loading the vehicle, distribute the cargo load equally so that you do not exceed either the Front or Rear Gross Axle Weight Rating (GAWR) or the Gross Vehicle Weight Rating (GVWR). The Gross Axle Weight Rating (GAWR) means the weight value specified by the chassis manufacturer as the load carrying capacity of a single axle system as measured at the tire-to-ground interfaces. This is the total weight a given axle is capable of carrying. Each axle has its own rating.

Have your vehicle weighed to determine the proper load distribution for your vehicle. Also distribute cargo side-to-side so the weight on each tire or dual set does not exceed one half of the GAWR for either axle.

For example, if the Front GAWR is 6,000 lbs., there should be no more than 3,000 lbs. on each tire. (If the left side weighs 3,100 lbs. and the right side weighs 2,700 lbs., at least 100 lbs. of the load should be shifted from the left side to the right side.) The GVWR is listed on the Vehicle Certification Label. (See page 0-3).

The total combined weight allowed for the vehicle, including trailer towing load weight, is known as the Gross Combined Weight Rating (GCWR). If trailer towing is not recommended, the GCWR will equal the GVWR.

NOTE: We recommend that you dump all holding tanks before traveling to avoid carrying unnecessary weight.

CAUTION

The weight of the loaded vehicle (including options, attachments, passengers, water, fuel, luggage and all other cargo) must not exceed the GVWR or GAWR of either axle.

FRONT AXLE TIRE ALIGNMENT

We recommend that you have the front suspension and steering alignment checked and adjusted after you have fully loaded the vehicle according to your needs. Thereafter, have alignment inspected periodically to maintain vehicle steering performance and prevent uneven tire wear.

WEIGHING YOUR LOADED VEHICLE

To check the weight of your fully loaded coach, locate a commercial weighing scale that is capable of weighing large trucks.

Drive the entire coach onto the scale. This weight should not exceed the Gross Vehicle Weight Rating (GVWR) specified on the Vehicle Certification Label near the driver seat. (See sample on page 0-3.)



GAWR (Both axles)

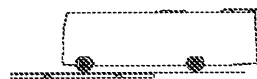

Front GAWR
(Front axle only)

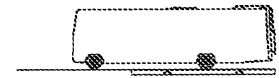

Rear GAWR
(Rear axle only)

To determine the weight on either front or rear axle, drive that axle only onto the scale. Neither axle weight should exceed the corresponding maximum axle weight rating specified on the certification label.

MAXIMUM OCCUPANCY

The following label is placed in a visible location in the driver compartment.

BELTED SEATING POSITIONS MAY EXCEED SLEEPING CAPACITY OF THIS VEHICLE. SEE OWNER MANUAL FOR OCCUPANCY AND WEIGHT RESTRICTIONS.

The number of belted seating positions in your motor home may exceed the number people used to determine maximum coach occupancy, called the Net Carrying Capacity (NCC) in the U.S. or Cargo Carrying Capacity (CCC) in Canada. To calculate the NCC or CCC, Winnebago uses vehicle sleeping capacity, however your coach may be equipped with more belted seating positions than sleeping positions to give passengers a choice of seating arrangements. You may use all of the belted seating positions providing you stay within your vehicle's GVWR listed on the Vehicle Certification Label (see page 0-3). However you use or load your vehicle, it is your responsibility to keep the weight within its stated gross vehicle weight rating.

ROOF LOADING

The roof is capable of carrying some light-weight articles while the vehicle is in motion. A roof-mounted luggage carrier designed for this purpose is available from your dealer. However, roof load while the vehicle is in motion is not to exceed 10 pounds per square foot or a maximum of 100 pounds.

When the vehicle is stationary, a cargo load of 100 pounds plus the weight of a 225 pound person to load the cargo or to conduct inspection and maintenance is permissible.

Weight added to both the roof and the trailer hitch contribute to the gross vehicle weight, which must not exceed the vehicle's GVWR.

TRAILER TOWING

The factory installed towing hitch on this coach is capable of pulling 3,500 lbs. (max.) and carrying 350 lbs. (max.) on the hitch ball. However, your coach's towing and hitch ball capacity may be less due to the coach's loaded weight and/or the towed vehicle's weight and hitch ball

weight. The combined weight of the coach and the towed vehicle should not exceed the coach's Gross Combined Weight Rating (GCWR). Also, the combined weight of the coach and the towed vehicle's hitch ball weight should not exceed the coach's Gross Vehicle Weight Rating (GVWR) or its rear Gross Axle Weight Rating (GAWR) listed on the Vehicle Certification.

Because of individual vehicle use and loading habits, we recommend weighing the vehicle while fully loaded to avoid exceeding any of the listed Gross Weight Ratings. See "Vehicle Certification Label" on page 0-3 for information on gross weight ratings.

Towing will affect vehicle handling, durability and fuel economy. Exceeding any of the listed Gross Weight Ratings will result in unacceptable overall vehicle performance. Maximum safety and satisfaction when towing depends on proper use of correct equipment. A hitch bar of appropriate steel and size should be selected to mate with the Winnebago towing receptor.

Installation of a proper trailer brake system is recommended. Check state regulations on trailer weight and trailer brake requirements to be sure you select the right equipment before towing.

Before descending a steep or long grade when towing a trailer, reduce speed and shift into a lower gear to control vehicle speed. Avoid prolonged or frequent application of brakes which could cause overheating and brake failure.

WARNING

For safety towing and vehicle handling, maintain proper trailer weight distribution.

The total weight of the motor home and the vehicle towed must not exceed the Gross Combined Vehicle Weight rating. Contact the chassis manufacturer to obtain the Gross Combined Vehicle Weight rating for your chassis.

CAUTION

Exceeding any of the recommended gross vehicle weight ratings may result in vehicle damage.

Do not install a frame equalizing type hitch on your vehicle.

See also - Trailer wiring connector, page 6-10.

PRE-TRAVEL CHECK LIST

Before starting the engine to leave on a trip, be sure your motor home has been properly prepared and maintained. This will ensure an enjoyable trip and help avoid delays. Use this checklist as a guide.

- Fluid Levels - Check and fill if necessary:
 - engine oil
 - transmission
 - power steering
 - radiator
 - brake
 - battery
 - windshield washer
- Wheel Lug Nuts - Check for tightness
- Tires - Check for proper cold inflation pressures as specified on the Vehicle Certification Label.
- Drive Belts - Check for proper condition and tension (not cracked, frayed, or loose, etc.)
- 110-Volt Generator (Optional) - Check oil level in generator engine.

WARNING

Never check oil level in generator while engine is operating.

- Fire Extinguisher - Make sure it is fully charged and secured in mounting bracket.
- Lights - Make sure all exterior lights operate.
- Sewer and Water Supply Hose - Unhook and store.
- TV Antenna - Make certain the TV antenna is lowered and seated in its support cradle.
- Loose Items Inside the Motor Home - Store or secure items.

- Pilot Lights - Make sure all pilots are off.
- Fuel Tanks - Check level.
- Water Tank - Fill with fresh water.
- Exterior Door and Step - Make sure doors are closed, locked and step retracted.
- Seats - Adjusted for comfortable position and locked in place.
- Mirrors - Adjust for maximum visibility from driver's seat.

TRAVEL TIPS

As you travel around the country in your motor home, you will pick up useful advice from other motor home owners.

A number of suggestions can also be obtained by reading articles and regular columns in outdoor and camping magazines. Some magazines and publishing companies print an annual park and campground directory. These can be found at your local news stand or RV supply dealer. Here are a few travel tips to begin with.

1. Always check for sufficient clearance. Know the height and width of your unit.
2. Always fill the fresh water tank at an approved potable water filling facility or a known purified drinking water source. Taste the water before filling the water tank in an unfamiliar location. The water in some areas may contain an undesirable taste. Do not use a new hose to fill the water tank. It can leave a distinct rubber or vinyl taste.
3. Showers can take a lot of water. Conserve water by taking a "Sea Shower". This is done by wetting down, turning off the water, soaping thoroughly and then rinsing.
4. Dump sewage only at approved dumping stations.
5. Store liquids in plastic containers with tight fitting caps to prevent spills.
6. Keep an eye on the water and holding tank levels. It is a good idea to dump the holding tank at least every two days.
7. When traveling with children, it is helpful to plan their wardrobe for a week. Place each days clothing in a plastic bag and label the bag with the child's name and day of the week for use.
8. Use sleeping bags whenever possible. They save laundry and take up less storage space than bedding.

SECTION 4

TRAVELING WITH YOUR MOTOR HOME

Sunflyer

9. Make sure all compartment doors have been closed and the door step has been stowed in the correct position before moving the vehicle.
10. Before traveling, make sure the refrigerator door has been secured. Use care when opening the refrigerator door after the vehicle has been stopped. Any articles that have shifted may fall out when the door is opened.
11. During peak tourist season and holidays, it is best to phone ahead and make reservations at the park where you plan to stop.
12. Some states or cities will not permit vehicles with LP gas containers to pass through highway tunnels. If your route includes a tunnel, check with the highway patrol or department of highways to avoid inconvenience.
13. Do not leave food or odor-causing material in your vehicle for extensive periods of time. Always allow damp clothing, swimwear, hunting gear, etc., to dry before stowing.
14. Become familiar with the fire extinguisher and make sure it is always fully charged. Remove and replace it and read instructions so you know the correct operating procedure before an emergency happens.
15. Make a list of all groceries, fresh meats, vegetables, newspapers, etc., that you may need and try to pick them up during your last fuel stop of the day. This will prevent leaving a good parking spot once you have arrived at your destination.
16. When you sit over the front wheels while driving, as in a motor home, you have a tendency to crowd the middle of the road. Check the side view mirror frequently to observe how close you are driving to the center line.

SEVERE WEATHER INFORMATION

One of the more serious conditions affecting the motor home traveler and camper is that of the weather. Whether you travel the high mountain terrain, the lower deserts and flatland or the plains of the midwest, the weather is always with you and subject to change, sometimes with little or no warning. However, adequate warnings are normally broadcast over local radio and TV stations.

Motor home travelers and campers often seek secluded areas for weekend recreation or extend-

ed summer vacations. Many recreational areas are vulnerable to severe weather situations, especially flash flooding conditions. A few simple precautions may help lessen the hazards of flash flooding or reduce your immediate involvement.

NOTE: We recommend that all motor home occupants become familiar with these safety precautions, and be alert to change in weather.

- Be alert, because thunderstorms can form at any time, in any month of the year. Thunderstorms can produce large amounts of rain over a small area in a short time, which may result in a flash flood. Listen frequently to weather reports on the radio for weather and flood conditions.
- When camping near a stream, leave plenty of sloping bank between you and the stream.
- Avoid deep canyons and dry washes during stormy or threatening weather. Be aware of alternate exits.
- If heavy rain occurs, move to high ground immediately (at least 30-40 feet above the canyon floor or bottom of dry wash).
- During a flash flood, if you cannot move your vehicle, abandon it. Do not attempt to return to your vehicle before the water has receded.
- Do not attempt to wade to your vehicle if the water is above your knees - fast moving water exerts an enormous amount of pressure, making it impossible to remain standing or walking.
- Do not try to drive through flooded areas.
- Follow instructions of local authorities. Leave immediately when advised to do so. Many lives have been lost because people did not heed warnings.
- Have on hand survival supplies for several days, including food, water, first aid equipment and necessary medications. In desert areas during hot weather allow 3-4 gallons of drinking water per person, per day.

- Before you leave home, inform someone of your destination and when you expect to return. Authorities at your destination should be notified immediately if you do not arrive on time.

REMEMBER THESE TERMS:

WATCH: Severe weather may develop in the specified area. Be alert and prepare for possibility of an emergency.

WARNING: Severe weather is occurring or is imminent in certain areas. Move to a safe location immediately.

We highly recommend that you obtain a weather radio. These radios offer up-to-date weather reports. The latest information and forecasts are broadcast by local National Weather Service offices in recorded messages that last from three to five minutes. These messages are replayed continually 24 hours a day. The recorded messages are revised every three to four hours, or more frequently when appropriate.

When severe weather threatens, forecasters at the local National Weather Service office interrupt the broadcasts with storm warnings, either recorded or “live” as the situation demands.

The frequencies used for NOAA Weather Radio (National Oceanic and Atmospheric Administration) nationwide are 162.40, 162.475 or 162.55 megahertz.

NIGHTTIME DRIVING

- Make sure all running lights and signal lights are clean and in working order. Have your headlights periodically checked and adjusted.
- Use care when passing other vehicles. Your motor home is a longer vehicle than a car, and you may have a more difficult time knowing when to pull back into your lane. If possible, have another person in the coach help you watch while maneuvering your motor home in traffic.

MOUNTAIN DRIVING

Special techniques must be used when driving in mountainous or hilly country.

Climbing A Hill

The transmission will automatically down-shift as needed to climb most hills. If the hill is long or very steep, however, you may need to manually shift to a lower gear to keep the transmission from repeatedly upshifting and downshifting. Select the lowest adequate gear range for the duration of the incline. See your chassis operating guide for more information.

CAUTION

Observe the engine temperature gauge more frequently than normal. If overheating occurs, pull off to the side of the road and allow the engine to thoroughly cool before refilling the radiator and restarting the engine.

Descending A Hill

When going down a long grade, you may need to manually shift to a lower gear, rather than keeping your foot on the brake pedal. A lower gear will allow the engine to provide a degree of braking action. Holding your foot on the brake pedal for an extended period may cause brakes to overheat, causing you to lose control of the vehicle. See your chassis operating guide for more information.

NOTE: Models on Freightliner diesel chassis are also equipped with an exhaust brake feature that works with the regular chassis brakes for enhanced braking when descending a hill. The exhaust brake is activated by a switch on the dash. See page 2-4 and the exhaust brake user's guide in your blue Operations Manual binder for more information.

CAMPSITE SELECTION

Try to pick as level a spot as possible on which to park your motor home. Whether you nose into a parking site or back into it depends on personal preference and the location of the site's utility hook-ups. Remember that the utility connections on your motor home are on the left (driver) side of the vehicle.

SECTION 4

TRAVELING WITH YOUR MOTOR HOME

Sunflyer

LEVELING

Leveling the motor home is very important, not only for your comfort but for appliances and plumbing as well. Some refrigerators are extremely sensitive to being off level. The ammonia vapor cooling system used in most RV refrigerators can “lock-up” and damage the refrigerator if it is not level. This is both inconvenient and costly. Also, water and holding tank level indicators may give false readings because water level is greater at one side of the tank than the other.

The refrigerator is installed level at the factory. So, if the refrigerator is level, the motor home is level. A small bubble-level sight is included in the refrigerator to help you determine refrigerator leveling.

Blocking

A motor home can be leveled using several methods, including sophisticated electronic-hydraulic systems. The most common and inexpensive method, however, is “blocking.”

This is done by stacking various lengths of planking (blocks) into a ramp-like formation in a low spot to drive the wheel onto, thus leveling the coach as shown.

Wedge a pair of wheel chocks or similar devices in front and back of a tire that is on the ground as shown to keep the coach from rolling forward or backward off the leveling blocks.

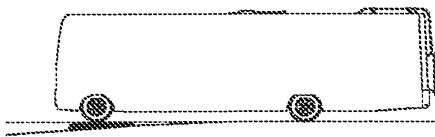

When placing blocks beneath a set of rear dual wheels, be sure the blocks support both tires so that the load weight is not resting on one tire, which could damage that tire.

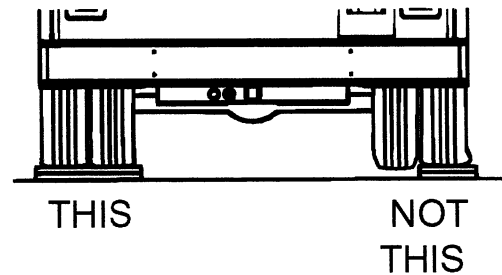

Blocking Rear Duals

To provide extra firmness, you can place inexpensive mechanical jacks, jack stands or hydraulic “bottle” jacks under the frame to keep the coach from moving on the suspension springs while walking around inside the coach. These devices are not intended to lift the coach; only to hold it rigid and steady.

NOTE: We do not recommend lifting any of the wheels off the ground for leveling. This could allow the coach to roll off the jacks, possibly resulting in damage to the vehicle.

EFFECTS OF PROLONGED OCCUPANCY

Your motor home was designed primarily for recreational use and short term occupancy. If you expect to occupy your coach for an extended period, be prepared to deal with condensation and humid conditions that may be encountered.

HUMIDITY AND CONDENSATION

Moisture condensing on the inside of windows is a visible indication that there is too much humidity inside the coach. Excessive moisture can cause water stains or mildew which can damage interior items such as upholstery and cabinets.

When you recognize the signs of excessive moisture and condensation in your coach, you should take immediate action to minimize their affects.

You can help reduce excessive moisture inside the motor home by taking the following steps:

Ventilate with outside air: Partially open one or more windows and a roof vent to circulate outside air through the coach. In cold weather, this ventilation may increase use of the furnace, but it will greatly reduce the condensation inside the coach.

Minimize moisture released inside the coach: Run the range hood fan while cooking, and open a bath vent while bathing or showering to carry water vapor out of the coach. Avoid making steam from boiling water excessively or letting hot water run. Avoid bringing extra moisture into the coach by way of soaked clothing or snow on shoes. Do not hang-dry wet overcoats or clothing inside the coach.

NOTE: Your coach is not designed or intended to be used as permanent housing. Using this product for long term occupancy or permanent housing may lead to premature deterioration of structure, interior finishes, fabrics, carpeting and drapes. Damage or deterioration due to long term occupancy may not be considered normal and, under the terms of the warranty, may constitute misuse, abuse, or neglect, and may therefore reduce your warranty protection.

(See also Safety Precautions, Section 1 of this manual.)

LP GAS SUPPLY

The LP gas system supplies fuel for the range, water heater, furnace and refrigerator (while in gas mode). When used and handled properly, this system is safe and economical and provides modern living conveniences wherever you travel.

SAFE USE OF THE LP GAS SYSTEM

The LP system is designed and built with strict adherence to both federal and recreational vehicle industry requirements for mobile LP gas equipment.

For your safety, there are many safety devices and backup systems installed, such as tank fill overflow valves, an interior LP gas detector/ alarm, and an interior carbon monoxide (CO) detector/alarm.

LP gas also contains an odor additive that you can smell if LP is present in the air.

Listed below are a few precautions to observe that will help you to use the LP gas system safely.

- Exercise caution at all times. Be familiar with the distinctive odor of LP gas. If a leak is suspected, turn off the supply valve immediately. Have the LP gas system checked by your dealer or a qualified LP gas service center.
- Do not tamper with the LP gas piping system, pressure regulator or gas appliances. Service and maintenance of LP gas system components should be performed only by your dealer or a qualified LP gas service center.
- Never attempt to connect natural gas to the LP gas system.
- Have the entire LP gas system inspected for possible leaks and missing or damaged parts at each tank filling. Also inspect before and after each trip, and any time trouble is suspected.
- Turn the LP supply valve off when not using

the LP gas system.

- Never use a wrench to tighten the tank supply valve. It is designed to close leak-tight by hand. If a wrench is required to completely close the valve, it is defective and must be replaced.
- Never allow the tank to be filled above the 80 percent level indicated by the flow of liquid gas out of the overflow valve or by the automatic stop-fill device.
- Be sure appliance and outside vents are open and free from obstruction when using the LP gas system.
- Never attach a lock or any device requiring a key to the LP tank compartment door. According to standards set for recreation vehicles, the LP supply valve must be readily accessible in an emergency.
- Exercise caution when drilling holes or attaching objects to the walls. Gas lines and electrical wiring could be seriously damaged and present an extreme safety hazard.

HOW LP GAS WORKS

LP (Liquified Petroleum) gas is a true gas compressed into liquid form for easy transportation and storage. LP gas is available in two types - propane and butane. It is also called tank gas, bottle gas, or simply LP.

LP is used by appliances in vapor form only, but is stored in the tank as a liquid under very high pressure. As the liquid gas is released, it reverts back to a vapor and expands to many times its compressed volume.

SELECTING FUEL TYPES

Butane burns hotter than propane, but will not develop a usable gas vapor at temperatures lower than 32° F. Propane, on the other hand, does not burn as hot but will convert to usable gas at temperatures down to -44° F. For this reason, propane is popular in cold climates, while butane

SECTION 5
LP GAS SYSTEM



and propane/butane mixtures are used most widely in milder climates.

NOTE: Most LP dealers normally handle only the type of LP gas commonly used in their climate and area. If you anticipate filling your tank in one of the warmer states prior to traveling to a colder area, it is advisable to request propane only. Otherwise your LP system may fail to operate if the temperature drops below 32° F.

LP GAS OUTPUT

Each gallon of liquid LP gas contains approximately 92,000 BTU's of heat energy; or about 36.2 cubic feet of dry gas for cooking, heating, water heating and refrigeration.

To find out how long a gallon of LP gas will last, you should determine the total BTU **input** on all your LP gas appliances in use. Let's say you have a furnace that has a 10,000 BTU **input** per hour of operation. A gallon of LP gas would last 9.2 hours of continuous operation (92,000 BTU's ÷ by 10,000 BTU's = 9.2). To estimate how long a gallon of LP gas lasts, try to determine what your total daily BTU input is, then divide into 92,000 to arrive at an approximate daily LP gas consumption.

LP TANK SYSTEM

The storage reservoir for the LP gas system is a horizontally mounted tank which is permanently attached to the vehicle frame. The tank is accessible only from the outside of the vehicle. The tank supply valve is located near the top center of the tank, next to the regulator. Before opening the supply valve, check to be sure all controls for gas appliances are in the "Off" or "Pilot Off" position. If this step is not performed, LP gas could accumulate inside the motor home creating a fire or explosion hazard.

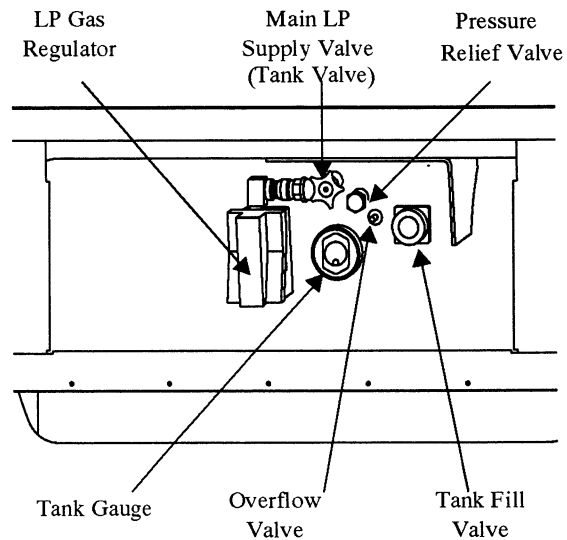

LP Gas Tank Capacity	
Models 33WB, 34WY, 35WH & 36WL (Chevy/Ford chassis)	*23 gal. (28 gal. w.c.)
Model 36WL (Freightliner chassis)	*30 gal. (39 gal. w.c.)

*LP Gas tank capacity shown is the usable "full" LP gas capacity, which is 80% of the tank manufacturer's listed water capacity (w.c. shown in parenthesis). An LP tank must have at least 20% of tank volume free to allow for expansion and proper vaporization of the liquid fuel. The tank is also equipped with mandatory safety shut-off equipment that prevents filling above this level.

REFILLING LP TANK

There are many LP gas refueling stations located throughout the country. These stations are listed in the telephone directory Yellow Pages under "Gas - Liquefied Petroleum - Bottled and Bulk."

Since the LP tank is permanently mounted to the frame, the motor home must be taken to an LP dealership for filling. Do not attempt to remove the LP tank from the vehicle. The tank is equipped with a fill adapter with both internal and external threads which allows easy filling with any LP filling equipment. The tank is full when liquid LP gas appears at the overflow valve.

NOTE: The LP tank is equipped with an automatic 80% stop-fill device.

WARNING

Make sure the filling attendant uses the 80% overflow valve when filling the tank. A tank should never be filled above 80% level to allow for vaporization and liquid expansion.

Do not place LP gas containers inside the vehicle. LP gas containers are equipped with safety devices which relieve excessive pressure by discharging gas to the atmosphere.

Do not place LP gas containers, gasoline, or other flammable liquids inside the vehicle. Fire or explosion may result

AIR IN THE LP GAS TANK

If your LP gas appliances do not stay lit or require frequent adjustment, even though you know the LP tank contains sufficient fuel, the problem may be air in the LP gas tank. Air in the tank mixes with the LP gas vapors causing them to burn poorly. This condition could linger for weeks if the air is not purged from the tank. Most LP gas dealers have equipment for purging air from LP gas tanks and will purge before refilling the tank.

TRAVEL WITH LP GAS

It is illegal for vehicles equipped with LP tanks to travel on certain roadways or through certain tunnels in the U.S. To avoid inconvenience, check state regulations concerning flammable gas transportation.

WARNING

Do not alter or remove LP tank gauge at any time.

WARNING

DO NOT FILL CONTAINER TO MORE THAN 80 PERCENT OF CAPACITY. Make sure the motor home is level when filling. It is possible to accidentally overfill the tank if the vehicle is unlevel, with the fill valve on the uphill side. Overfilling the LP gas tank can result in uncontrolled gas flow, which can cause fire or explosion. A properly filled container will contain approximately 80 percent of its volume as liquid LP gas.

All pilot lights must be extinguished and supply valve closed before refilling LP gas tanks or vehicle fuel tanks.

Do not smoke or expose an open flame while near an LP refueling area. LP gas is heavier-than-air and extremely flammable.

Never use an open flame to test for LP gas leaks.

Replace all protective covers and caps on LP system before filling.

Never fill the LP tank with engine or generator running.

REGULATOR

The pressure regulator is protected from the elements by a plastic cover which should be left in place at all times. Only your dealer or a qualified LP gas service should remove the regulator cover for adjustments.

WARNING

Inspect the pressure regulator vent hole periodically for blockage. If any obstruction is apparent, have the regulator serviced by your dealer or a qualified LP gas service center.

LP gas regulators are installed with the diaphragm vent facing downward. Make sure that the regulator vent always faces downward to minimize vent obstruction which could result in excessive pressure, causing a fire or explosion.

Regulator freeze-ups are caused by the presence of moisture in fuel. This moisture will pass through the cylinder valve and into the regulator where it can freeze. Fuel producers, tank and bottle manufacturers and LP gas dealers take every precaution to reduce moisture, but sometimes only a fraction of an ounce entering the tank can cause problems. To help avoid the possibility of freeze-up, always keep tank control valve closed when not in use, even when tank is empty, to prevent moisture from collecting on the inside.

If regulator freeze-up should occur, you may attempt to thaw the regulator using a light bulb. **DO NOT USE AN OPEN FLAME OR HEAT LAMP.**

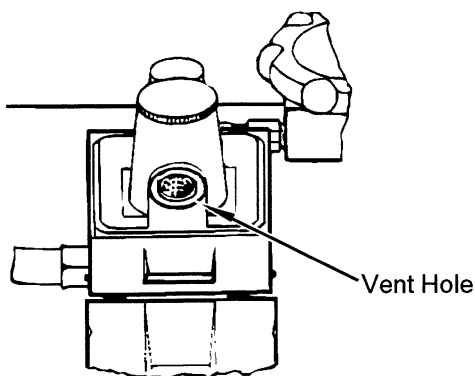

LPG PRESSURE REGULATOR
(COVER OPEN)

If moisture begins to cause problems, have your LP gas dealer inject a small amount of dry methyl alcohol in your tank (approximately one ounce to 20 pounds or one pint to 100 gallons) to help guard against regulator freeze-ups.

In very cold weather when a large volume of gas is being used for heating, it is possible to experience a loss of gas pressure. At first, this problem may appear to be caused by a regulator freeze-up, but is actually caused by failure of the liquid gas to vaporize as fast as it is needed. As the temperature becomes colder, it is increasingly harder for the liquid LP gas to vaporize. At the same time, the demand for LP to produce heat increases to the point where the system cannot maintain production.

The only solution to this problem is to reduce the consumption of gas where possible. Adjusting the temperature on the gas/electric refrigerator may be a first step. Using less hot water will help as well.

LP GAS LEAKS

The following label has been placed in the vehicle near the range area. If you smell gas within the vehicle, quickly and carefully perform the procedures listed.

IF YOU SMELL GAS

1. Extinguish any open flames, pilot lights and all smoking materials.
2. Do not touch electrical switches.
3. Shut off the gas supply at the tank valve(s) or gas supply connection.
4. Open doors and other ventilating openings.
5. Leave the area until odor clears.
6. Have the gas system checked and leakage source corrected before using again.

LP GAS ALARM - See page 1-3.

WARNING

Never use an open flame to test for gas leaks. When testing for gas line leaks with a soapy water solution, DO NOT use a detergent containing ammonia or chlorine. These substances may generate a chemical reaction causing corrosion to gas lines, resulting in dangerous leak conditions.

<u>Temperature</u>	<u>Percentage of BTU's Available at 0° F.</u>
20° F.	200%
10° F.	150%
0° F.	100%
-5° F.	75%
-10° F.	50%
-15° F.	25%
-20° F.	12 1/2%
-44° F.	Propane will not vaporize

WINTER USE OF LP GAS

Due to vaporization characteristics of LP gas, it is important that the winter camper knows how to most efficiently use the LP system. The vaporization rate of LP gas decreases in a direct relationship to a decrease in temperature. As explained in the "Selecting Fuel Types" section, butane does not vaporize below 32° F, so propane must always be used in cold climates. However, even propane vaporizes at a slower rate as it becomes colder.

The greater the amount of liquid gas in the tank (up to 80% level) the greater the amount of LP gas vapor generated. The following is an example of the number of BTU's available from an 84-pound tank at 0° F at three levels. As you can see, the number of BTU's decreases as the tank is emptied. Nearly twice as many BTU's are available from a full tank than one that is one-fourth full.

BTU's Available at 0° F.	
<u>Tank Level</u>	<u>BTU's</u>
80%	64,000
50%	50,400
20%	33,000

The following LP Gas Vaporization and Temperature Relationship chart typifies the LP gas loss with a decrease in temperature. The percentage figures are the increase or decrease of vapor that would be available at 0°F. These figures apply to any size LP gas tanks.

(See also Safety Precautions, Section 1 of this manual.)

Your motor home is equipped with an electrical system consisting of two separate voltages; a 12-volt DC system and a 110-volt AC system. The 12-volt system consists of two internal power sources, while the 110-volt system is operated from an outside power source or the optional 110-volt generator.

110-VOLT AC SYSTEM

The 110-volt system operates from an outside 110-volt utility service such as those at campgrounds, or from the optional 110-volt generator. When the power cord is connected to an outside power source, or when the generator is in operation, the power converter automatically changes a portion of the 110-volt current to 12-volt DC current. All equipment in the motor home that is normally powered by the auxiliary battery is then powered through the converter.

In addition, the following equipment is entirely dependent on the 110-volt generator or shoreline connection: roof air conditioner, refrigerator (when placed in 110-volt mode), microwave oven, and other 110-volt electrical equipment used at convenience outlets.

EXTERNAL POWER CORD (Shoreline)

The external utility power cord (commonly referred to as a "shoreline") is stored in the utility compartment on the left (driver's) side of the coach. The coach input socket is on the left side-wall.

WARNING

Do not connect the external power cord to any receptacle **until** you have contacted the owner and/or attendant of the premises to verify proper polarity and grounding.

It is the responsibility of the owner of the electrical receptacle to ensure that the receptacle is properly wired and grounded.

Reverse polarity and improper grounding of the vehicle can cause personal injury or death

The power cord is designed to ground the electrical system through the receptacle. It is also designed to carry the amperage output of most campground outlets. If the electrical receptacle to be used is designed to mate with the prongs on the power cord plug, the electrical connection can be expected to carry rated load.

Your coach may be equipped with either 30-amp or 50-amp shoreline service depending on the power requirements of electrical appliances and equipment in the coach. You can tell which type you have by looking at the prongs on the shoreline plug.

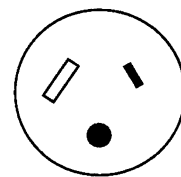

30 Amp Receptacle

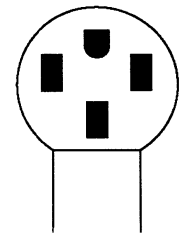

50 Amp.
Power Receptacle

The optional 50-amp shoreline gives your coach extra current handling capacity. This allows you to run the central air conditioning system at maximum (both compressors running) without the inconvenience of frequently tripping circuit breakers.

CONNECTING THE SHORELINE

Remove the cord from the storage compartment and plug the coach end of the cord (yellow plug) into the coach input receptacle.

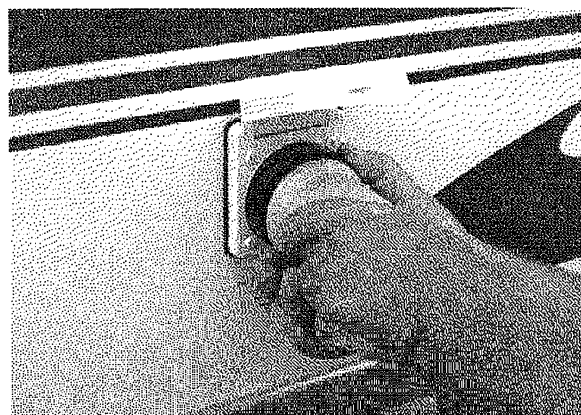

Align the plug with the prongs in the receptacle and insert firmly into receptacle. Twist the black retainer collar on the plug handle to lock the plug onto the receptacle during use.

Then plug the shore end of the cord (black plug end) into a suitable 50-amp power receptacle to provide external power to the coach and converter/charger system.

WARNING

Do not plug the power cord into an outlet which is not grounded, or adapt the plug to connect to a receptacle for which it is not designed.

Be sure that all the prongs of the supply cord are properly plugged into the receptacle.

Do not connect the power cord to an extension cord.

Park Fuses or Breakers

Most campgrounds are equipped with a fuse or circuit breaker at the receptacle. This protects the park's wiring, as well as the power cord on your vehicle, from electrical damage. If electrical power fails, contact the park attendants and have them check the fuse or breaker for your supply receptacle.

After disconnecting the power cord, neatly replace it in the storage compartment.

POWERLINE ENERGY MANAGEMENT SYSTEM (EMS)

The energy management system (EMS) monitors the electrical usage of the appliances and equipment in the coach and distributes the electrical loads to avoid nuisance tripping of the shoreline circuit breaker. This system works together with the energy efficient Coleman Power Miser roof air conditioner units to allow you to run both front and rear units at the same time on a 30-amp shoreline connection.

Please read your Power Line Energy Management System Owner's Guide for important information on running both front and rear roof air conditioner units at the same time. This guide will also explain how this system operates under several conditions, whether 20-amp, 30-amp or 50 amp connections.

POWER CONVERTER SYSTEM

The power converter changes 110-volt AC current from the auxiliary generator or the shoreline into 12-volt DC current for use by 12-volt equipment in the motor home.

Certain circuits, however, remain unchanged for use by items which require 110-volt current, such as the air conditioner(s), the refrigerator in AC mode, the microwave oven, etc.

Current drawn from the coach batteries passes through the power center unchanged, although it is routed through a series of protective circuit breakers located on the house 12-volt and 110-volt breaker panels.

NOTE: The converter will not change 12-volt DC current to 110-volt AC.

If your coach is equipped with a DC-AC power inverter, the converter does not function while the inverter is being used.

WARNING

Do not store anything around or on top of the converter, or in front of the cover. The converter generates heat while operating, and needs unrestricted air flow for proper cooling.

Power Converter and Circuit Breaker Locations

The converter system is made up of individual components located in various parts of the coach.

- **Converter Unit:** located in an exterior basement storage compartment. It may be located behind a protective plastic cover.

NOTE: The converter unit is replaced by the optional 1500W inverter/charger if your coach is thus equipped. See "1500W Inverter/Charger" on page 6-4.

- **House 12-Volt Circuit Breaker Panel:** behind small cabinet door below refrigerator; contains pop-out circuit breakers

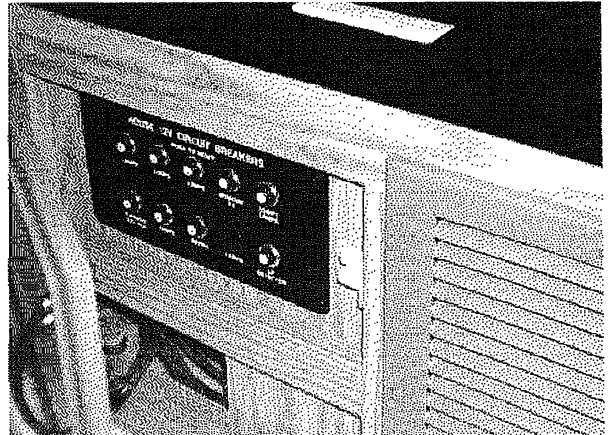

House 12-Volt Breaker Panel

- **110-Volt Breaker Panel:** behind access door on the lower aisle side wall near the bathroom.



House 110-volt Breaker Panel

110-Volt Circuit Breakers

The breaker panel protects all 110-volt components in the motor home from either an overload on the circuit or a short in the wiring or component itself. When an overload or short develops, the breaker will open preventing any further flow of electricity and, therefore, damage to the system.

Shut off the equipment (example: air conditioner) and allow a brief cooling period. Then reset the breaker by moving the switch to "Off" and back to "On". If the breaker is

continually tripped and no overload is evident, have the system checked for a short in the wiring or the appliances..

Charging Section

The converter charges coach batteries while 110-volt external power is connected. The converter will automatically “sense” the condition of the RV battery. If it is below “full charge”, the Charging Section will start charging the battery.

If the coach batteries have been extremely discharged, they will accept charge at a relatively high amperage rate. If they are only slightly discharged, they will charge at a lower amperage rate. The rate of charge will decrease as the batteries reach “full charge”, then will remain “trickle” charging at a very low amperage rate. If your storage battery does not charge as described above, it is possible the battery is defective.

Converter Overload Protector

The converter overload protector will shut-down the converter if it becomes overheated. This can result from operating above its maximum limit for an extended period of time or by obstruction of ventilation to unit.

NOTE: When the converter is not operating, 12-volt lights and motors will draw power from the coach batteries.

The converter overload protector will reset itself after a cool-down period. The lights and motors will resume operating from the converter. If the overload protector trips again shortly after reset, take immediate steps to correct cause of overheating. A portion of RV 12-volt load (lights or motors or both) should be turned off to reduce total load. Also, inspect power converter section to make sure ventilation is not obstructed.

NOTE: The converter will not change 12-volt DC current to 110-volt AC.

Further Information

Refer to the converter manufacturer’s information provided in your Motor Home Operations Manual binder for additional information about your power converter system.

110-VOLT RECEPTACLES (Outlets)

A number of standard AC electrical outlets are provided throughout the coach for connecting small appliances such as televisions, radios, toasters, etc. Outlets are also located on the outside of the coach near the entrance door.

GROUND FAULT CIRCUIT INTERRUPTER

Exterior, bath and galley outlets are connected to a GFCI (Ground Fault Circuit Interrupter), which is an extremely sensitive circuit breaker that will help to protect against severe electrical shock if a ground fault develops. If such a condition occurs, the GFCI will break the circuit by turning off the power to the protected outlets. Should this occur, unplug all the appliances on that circuit and press the reset button on the GFCI equipped outlet.

If the GFCI keeps tripping, have the electrical system checked and repaired if necessary before using again.

The GFCI outlet is located in the bath, bedroom or dinette area, depending on the floor plan of the vehicle.

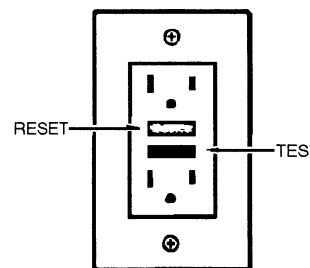

WARNING

The GFCI will not completely eliminate electrical shock. Small children and persons with heart conditions or other disabilities which make them especially sensitive to electrical shock may still be injured by a 110-volt receptacles even though protected by a Ground Fault interrupter.

NOTE: In compliance with CSA electrical codes, the appliance outlet in Canadian equipped coaches is not connected to a GFCI protected circuit.

AUXILIARY 110-VOLT GENERATOR

Optional

Consult the generator manufacturer's information provided in your Owner Operation Manual binder for instructions on operation, troubleshooting and maintenance.

This coach may be equipped with one of several models of generators. Consult the generator owner's manual in your Motor Home Operations Manual binder for specific instructions on starting, stopping your generator

NOTE: Gasoline powered or diesel powered generators draw their fuel from the main chassis fuel tank. LP gas powered generators draw fuel from the LP gas tank. After extensive generator use, you may notice decreased levels in the affected fuel tank.

WARNING

Careless handling of the generator and electrical components can be fatal.

Never touch electrical leads or appliances when your hands are wet, or when standing in water or on wet ground.

Do not attempt to repair the generator yourself. Service should be performed by an authorized service center.

Do not plug the power cord into the generator receptacle while the generator is running.

Automatic Power Transfer Switch

Your coach electrical system is equipped with an automatic power transfer switch. The transfer switch is normally connected to the shoreline cord.

When the generator is started, the transfer unit will switch the power feed to the generator after 20 seconds. The twenty-second delay is to allow the generator to start easily without an electrical load.

When the generator is shut down, power is automatically switched back to the shoreline cord.

STARTING AND STOPPING THE GENERATOR

This coach may be equipped with one of the several models of generators. Consult the generator owner's manual in your Motor Home Operations Manual binder for specific instructions on starting and stopping your generator.

NOTE: Gasoline powered or diesel powered generators draw their fuel from the main chassis fuel tank. LP gas powered generators draw fuel from the LP gas tank. After extensive generator use, you may notice decreased levels in the affected fuel tank.

Basic Generator Operation:

Starting:

For your convenience, generator switches are located on the dash, on the range hood, and on a nightstand cabinet in the bedroom as well as on the genset unit itself in the generator compartment. The generator starter circuit does not rely on the automotive battery, so the switch will operate whether the ignition switch is on or off.

- See generator manufacturer's operating information for specific instructions.
- Reduce all electrical loads. (Shut off lights, fans, appliances, etc.)
- If the generator has not been run for two weeks or more, you may need to prime the fuel system before attempting to start.
- Press the generator starter switch on and hold until generator engine is running, then release.

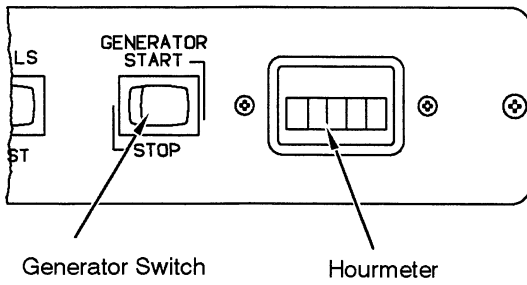

- Let the generator engine stabilize and run smoothly before turning appliances or electrical equipment on.
- Do not overload generator by turning too many items on. Overloading will cause the circuit breaker on the generator to trip. If this happens, the generator will run but no electricity will be present in the coach. You must then reset the circuit breaker on the side of the generator.
- Refer to the output specifications of your generator in the generator manufacturer's manual. Then see the following electrical load chart to estimate your typical loads.

Stopping:

- Before shutting generator down, turn off electrical loads and let engine run at no-load for a few minutes to cool down.
- Press the generator switch Off and hold until the generator engine comes to a complete stop.

CAUTION

Continuous generator overloading can cause high operating temperatures that can damage the generator windings. Keep the electrical loads within the generator wattage ratings.

Approximate Power Requirements of Common Appliances	
Appliance or Tool	Approximate Power Consumption (Watts/Amps)
Vacuum cleaner	200-500W/1.7-4.3A
Coffee Maker	550-700W/4.8-6.1A
Hair dryer	800-1500W/7.0-13.0A
Electric clothes iron	500-1200W/4.3-10.4A
Electric blanket	50-200W/0.4-1.7A
Television	80-100W/0.7A
Electric drill	250-750W/2.2-6.5A
Air conditioner	1400-2000W/13-19A
Converter	300-500W/2.6-4.3A
Microwave Oven	700-1500W/6.0-13.0A

GENERATOR HOURMETER (If Equipped)

This meter is located on the range hood. It registers the total number of hours that the generator has been operated. Refer to the hourmeter to determine when periodic maintenance is due and to record services which have been performed.

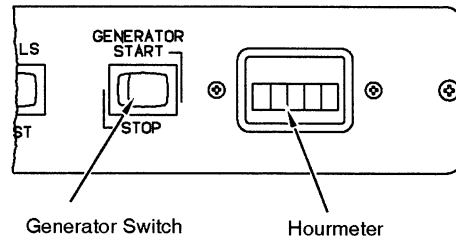

NOTE: While the generator is running it is normal for the hourmeter to make a periodic "ticking" sound.

OPERATION WARNINGS AND CAUTIONS

WARNING

The exhaust of all internal combustion engines contains carbon monoxide (CO). This poisonous gas is colorless, odorless, tasteless, and lighter than air. The exhaust systems of both your motor home engine and your generator engine have been installed with your safety in mind. However, certain precautions must be taken when using them to protect yourself from conditions beyond the control of the manufacturer.

1. **Do not** simultaneously operate the generator engine and a ventilator which could draw exhaust gases into the vehicle.
2. **Do not** open windows or ventilators on the end or side of the vehicle where exhaust pipe of the generator is located.
3. **Park the vehicle** so that the wind will carry the exhaust away from the vehicle. Also, note the position of other vehicles to be sure their exhaust will not enter your vehicle.
4. **Do not** operate the generator engine when parked if vegetation, snow, buildings, vehicles, or any other object can deflect the exhaust under or into the vehicle.

Check auxiliary generator oil level frequently during periods of use. Refer to the generator manufacturer's information in your Motor Home Operations Manual binder for specific recommendations.

WARNING

Never check generator oil level while generator engine is running.

12-VOLT DC SYSTEM

The DC voltage system consists of the automotive battery and the 12-volt motor home auxiliary batteries.

Automotive (Starting) Battery

The automotive battery is used solely to operate the engine starter and all automotive accessories and controls found on the instrument panel. This includes the horn, speed control, all exterior lights, radio, windshield wipers, rear auto heater fan, etc.

Coach Batteries

The coach batteries supply current to all 12-volt equipment located in the living area of the motor home. This includes interior lights, range exhaust fan, furnace fan, water pump, water level and holding tank gauges, 110-volt generator starting, refrigerator and bath roof vent fan. The coach battery may also be used to start the engine if the automotive battery is dead. Refer to "Aux. Start Switch."

The coach batteries are automatically charged by the engine alternator when the engine is running.

House 12-Volt Circuit Breakers

All 12-volt circuits and equipment in the coach (house) area of the motor home are protected by a circuit breaker panel. When a circuit is overloaded or a short develops in any part of the system, a breaker will shut down that circuit. If this happens, turn off all affected lights or appliances and reset the breaker.

A label on the panel states the amperage rating and circuit protected for each breaker.

The house breaker panel is mounted behind a small door, below the refrigerator.

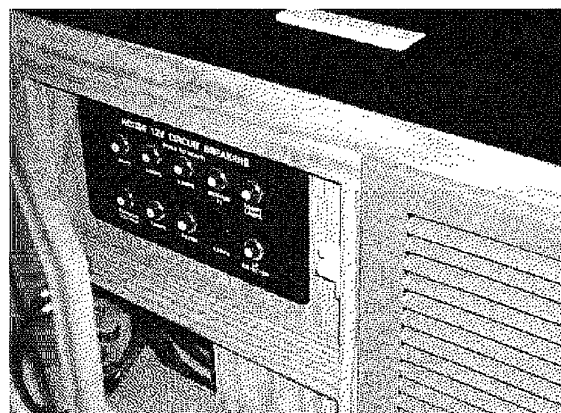

12-Volt Automotive Circuit Breakers and Fuses

The 12-volt automotive circuit breakers and fuses are located on a panel on the firewall beneath the left side of the dash, ahead of the driver's left foot while seated in the driver seat. To remove the protective cover, turn the twist lock to the left, then pull the cover outward and up.

SOLAR PANEL WIRING - Standard

Your coach is pre-wired for adding a roof mounted solar charger panel if your coach is not already equipped with this option. Because the 2-pin snap connectors are designed to connect the optional solar panel and charge indicator, we recommend that you obtain the correct components from your Winnebago Industries authorized dealer. (Panel: Winnebago P/N 115504-01-000/ Indicator: P/N 115505-01-000)

See your dealer for proper installation.

SOLAR CHARGER PANEL - Optional

The 10-watt roof-mounted solar charger panel uses the sun to help keep your batteries charged. A charger indicator light is located on a cabinet wall in the galley area near the dinette table and thermostat or range hood monitor panel.

The light will glow red when the solar panel is charging the coach batteries. The greater the rate of charge, the brighter the light. When the batteries reach full charge the light will gradually dim, then darken.

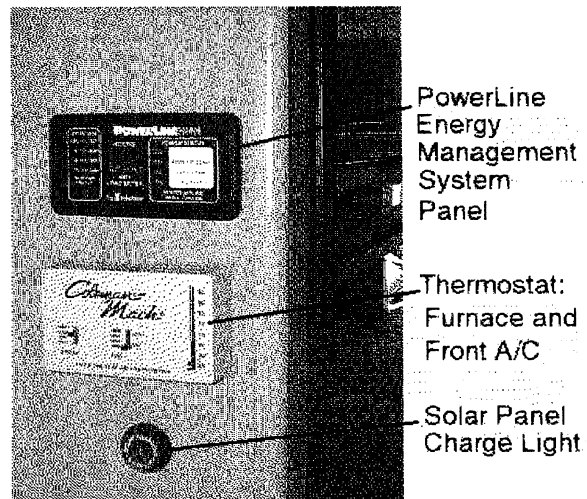

NOTE: The solar battery charger is not intended to make the coach battery system "maintenance free." The solar panel will not completely compensate for continuous low amperage draw from components such as the LP gas leak detector, the clock in the dash radio and the radio station memory circuitry, for example. Although the solar panel system can help to extend battery life, the coach shoreline should be plugged in routinely to "top off" the batteries. We also recommend following regular battery inspection and maintenance, especially in cold weather.

BATTERY INFORMATION

The coach batteries are "deep-cycle" type batteries specially designed for recreational vehicle use. They will provide longer lasting power than standard automotive batteries, and will withstand the frequent drain-and-recharge cycles that occur under the demanding conditions of a camping outing.

BATTERY ACCESS

The batteries are located beneath the top entrance step. Unhook the latch assembly fastening the top step and remove.

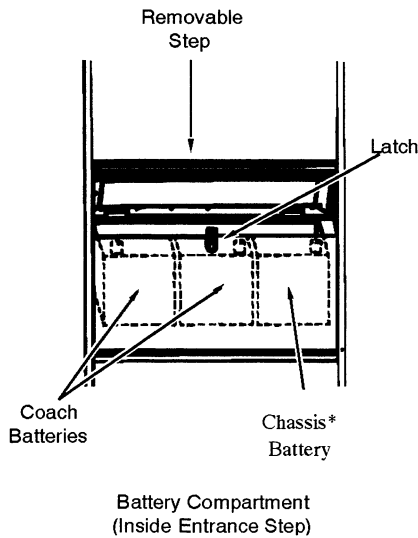

**NOTE: The chassis batteries for models on Freightliner diesel chassis are located in a compartment on the left side of the vehicle to the rear of the rear wheels. Two coach batteries are standard.*

BATTERY MAINTENANCE

Lead-acid type batteries are electro-chemical devices for storing and releasing electrical charge. As such, they are simply an electrical reservoir, not an electrical source. As soon as energy is removed from the battery, it should be replaced by the engine alternator or the RV converter system.

If a battery sits unused for 30 days or more, especially during warm weather, it can develop a deposit of sulfate crystals on the metal plates inside the battery. This condition is called sulfation or sulfating, and prevents the battery from either releasing or accepting a charge. If this condition occurs, the battery must be replaced.

If a battery does not contain at least 80% charge during freezing temperatures, the electrolyte can freeze and crack the battery case.

The two best defenses against sulfating and insufficient charge are to:

1) turn off the Auxiliary Battery switch to avoid parasitic discharge (the trickle discharge caused by directly connected components like LP gas detectors or digital clock displays in the range hood or radio, etc.), and

2) check the battery and recharge as necessary at least once a month during long storage periods.

Turn the Aux. Batt. Switch off to avoid electrical arcing when attaching or detaching charger clamps.

NOTE: We do not recommend leaving the shore-line plugged in continuously during storage periods because the batteries can lose electrolytic fluids and become damaged from continuous charging without periodic use. We recommend following regular battery inspection and maintenance, especially in cold weather.

Further precautions are:

- Remove the battery from the coach.
- Store it in a cool place on a wooden or rubber pad to inhibit conductive transfer.
- Check the state of charge periodically to avoid discharge or sulfating.
- Make sure the batteries always remain securely clamped in the battery tray.
- Make sure battery cable clamps are tight on the terminal posts and are free of corrosion.
- Neutralize corrosion buildup or acid film on top of battery by washing with a baking soda/water solution. Rinse with clear water.

NOTE: Make sure vent caps are on securely to prevent baking soda solution from entering the battery and contaminating the electrolyte fluid.

WARNING

Before removing any battery cables or battery, make sure all 12-volt equipment in the motor home is off and the power cord has been disconnected.

Replace any damaged cables at once. Always remove jewelry and wear protective clothing and eye covering when checking or handling batteries.

SECTION 6 ELECTRICAL SYSTEMS

Sunflyer

- Clean and tighten battery terminals and have the specific gravity checked at least once a year.
- Every two months, or more often in hot weather, check the battery fluid level. If necessary, fill with distilled water to approximately 3/8 inch above the plates. **DO NOT OVERFILL.** If water is added during freezing weather, either charge the battery or drive the motor home several miles to mix water and electrolyte to prevent freezing.
- Fluid level check may be omitted if equipped with maintenance-free batteries.

WARNING

To prevent wiring damage, it is essential when replacing the cables on the battery, or when using a "booster" battery, that the positive post and the positive cable be attached and the negative post and negative cable be attached. The posts are marked (+) plus and (-) minus. If a "fast charger" is used while battery is in the motor home, disconnect both battery cables before connecting the charger. Never attempt to charge or boost a frozen battery.

TM = Tail lights
GD = Ground
LT = Left Turn*
RT = Right Turn*
S = Brake lights
A = Backup lights

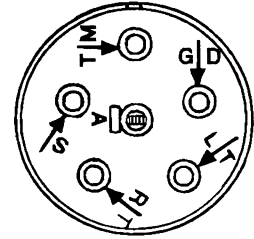

**NOTE: On Ford chassis, these turn signal connection also include a brake light function.*

BATTERY CONDITION METER

See related item under "Monitor Panel" in section 8, Appliances.

AUX. START SWITCH

See section 2, Driving Your Motor Home for information on Aux. Start Switch.

TRAILER WIRING CONNECTOR

Your coach is pre-wired for trailer or car towing lights with a 6-pin socket on the rear bumper. The connector plug is supplied in the coach parts package provided to you by your dealer when you took delivery of the vehicle.

The diagram shows proper connection of trailer or tow vehicle wiring to the coach light system. Remove the small screw near the end of the plug and slide the contact assembly out of the barrel.

FRESH WATER SYSTEM

The fresh water system provides water to the galley sink, shower, bathroom lavatory, toilet and water heater. Water may be supplied by either of two sources:

- a water tank located within the motor home, or.
- any external water source to which the motor home may be connected, known as “city water”.

FRESH WATER TANK FILLING PROCEDURES:

Always fill the fresh water tank at an approved potable water filling facility or a known purified drinking water source.

You can fill your water tank using either of two methods; gravity fill or city water pressure fill.

Gravity Fill: Insert hose into fill opening and turn water supply on. Tank is full when water flows from overflow tube beneath coach. The gravity fill tube is located behind a small, lockable door on the right (passenger) sidewall toward the back of the coach.

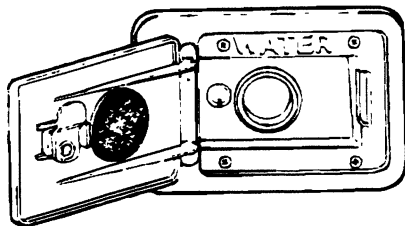

WATER TANK FILL

City Water Pressure Fill: Attach hose to city water connector. Turn fill valve to “Water Tank Fill”, then turn city water supply on. Tank is full when water flows from gravity fill tube. The city water connector is located in the utility system compartment on the left (driver) side of the coach.

NOTE: Because city water pressure varies from location to location, we recommend using an in-line water pressure regulator

to prevent damage to any components, connections and seals in your fresh water system.

A water pressure regulator may be obtained from any well stocked RV dealership retail center and some retail discount centers. These devices simply connect in-line between the supply hose and the city water input on the coach.

We recommend a regulator that controls water pressure to 40 psi maximum.

NOTE: Be sure to open the gravity fill door to prevent pressure build up while filling the tank from the city water connector.

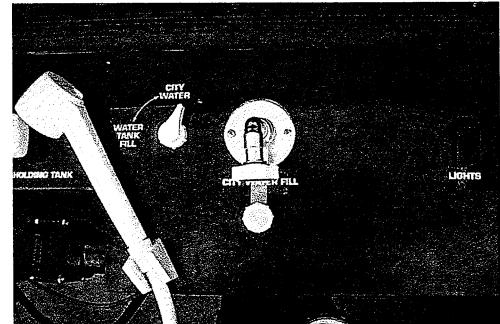

NOTE: Always keep the tank fill valve pointed to “City Water” unless you are filling the tank. If this valve is pointing to “Water Tank Fill” while using city water, the water will keep flowing into the tank and out the gravity fill tube.

Fresh Water Tank Capacity

Model 33WB & 35WH.....	70 gal.
Model 36WL (Freightliner chassis).....	86 gal.
Model 34WY & 36WL (Chevy/Ford chassis).....	100 gal.

WATER PUMP

Pressure for the water system is supplied by a water system demand pump which is fully automatic after initial priming. When a faucet is opened, the pump begins operation to provide a

constant flow from the tank. When the faucet is closed, the pump automatically shuts off.

Water Pump Switch

Your coach is equipped with water pump switches in three convenient locations:

- on the range hood monitor panel (See section 8)
- in the bathroom
- in the exterior shower compartment on the outside of the coach (See page 7-4).

Initial Start-Up

1. Make sure that all water drain valves are closed, including water heater valve. (Refer to Section 10.)
2. Turn water pump switch to "OFF" position.
3. Fill water tank.
4. Open all faucets, hot and cold.
5. Turn on pump switch.
6. Close each faucet as it begins to deliver a steady stream of water (close cold water first). Leave hot water faucets on until they also deliver a steady stream of water. This will ensure that the water heater is filled with water.
7. Check to be sure pump stops soon after all faucets have been closed.
8. Pump is now ready for automatic operation. Pump will start when a faucet is opened and stop when the faucet is closed.

ACCUMULATOR TANK

A pressurized accumulator tank is installed in the water line directly upstream from the water pump located in the rear compartment on the driver or passenger side of the coach.

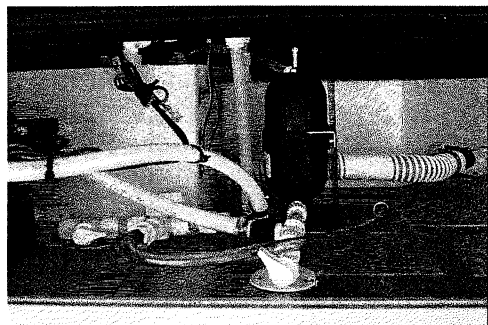

The accumulator tank holds a small amount of water under pressure of 20 psi to reduce water line pulsation noise and pressure variations when using the water pump system. This also contributes to longer pump life, less pump cycling, and less amperage draw by the water pump from the coach batteries.

NOTE: The accumulator tank has a precharge pressure which must be checked monthly and maintained at 20 psi for the system to work properly.

Adjusting Precharge Pressure

A tire-type valve stem is provided on the end or top of the accumulator tank to check or add air pressure.

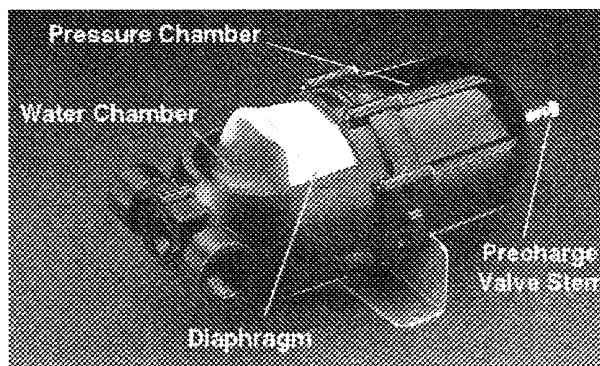

When adding air, do not exceed 20 psi tank precharge pressure because you may risk rupturing the pressure bladder inside the accumulator tank. Before checking precharge pressure, drain the accumulator tank by turning off the water pump and opening a faucet to drain off water line pressure. Because of the relatively small capacity of the bladder, check pressure with a standard tire pressure gauge before adding air, then if necessary, add air in small bursts, checking pressure between each burst until 20 psi is attained.

Overfilling will also push the bladder too far and reduce the volume of water held in the accumulator tank, making the system inefficient.

The precharge valve stem cap **must be tight** to prevent pressure leak-down.

Further Information

See manufacturer's information supplied in your motor home operation manual binder for complete maintenance instructions and precautions.

EXTERNAL WATER SUPPLY ("City Water")

To connect to an external source:

1. Turn the demand pump switch to Off. Also be sure fill valve is turned to "City Water" as shown
2. Attach a hose from the external water source to the city water connection in the utility compartment on the left side of your vehicle.
3. Turn on the external water source.

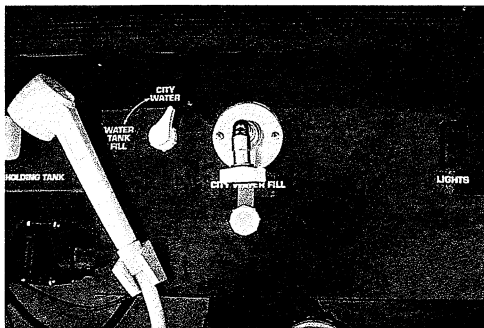

When connected to an outside source of water, the water bypasses the demand pump and storage tank and supplies pressure directly to individual faucets and toilet. A check valve built into the pump prevents water from entering the pump and filling the storage tank.

To disconnect from the external source:

1. Turn the external source off.
2. Open a faucet inside the vehicle to relieve line pressure.
3. Disconnect the hose from the coach.
4. Stick your finger up inside the connection and gently press the backflow valve upward to drain any water left in the line.
5. Replace the protective plug back into the threaded collar on the connection.

INSTRUCTIONS FOR DISINFECTATION OF FRESH WATER SYSTEMS ON RECREATION VEHICLES

(As approved by the U.S. Public Health Service)

To assure complete disinfection of your fresh water system, it is recommended that the following procedure be followed on a new system, one that has not been used for a period of time, or one that may have become contaminated. This procedure is also recommended before long periods of storage such as over winter.

1. Prepare a chlorine solution using 1 gallon of water and 1/4 cup of household bleach (sodium hypochlorite solution). With tank empty, pour chlorine solution into the tank. Use 1 gallon solution for each 15 gallons of tank capacity. This procedure will result in a residual chlorine concentration of 50 ppm in the water system. If a 100 ppm concentration is required as discussed in item 3, use 1/2 cup of household bleach with 1 gallon of water to prepare the chlorine solution. One gallon of the solution should be used for each 15 gallons of tank capacity.
2. Complete filling of tank with fresh water. Open each faucet and run the water until a distinct odor of chlorine can be detected in the water discharged. Do not forget the hot water taps.
3. Allow the system to stand at least 4 hours when disinfecting with 50 ppm residual chlorine. If a shorter time period is desired, then a 100 ppm chlorine concentration should be permitted to stand in the system for at least 1 hour.
4. Drain and flush with fresh water.

WARNING

Chlorine is poisonous - recap bottle and clean utensils after use.

Never use automotive type antifreeze in your potable water system as it is poisonous.

WATER PURIFIER SYSTEM

The water purifier system uses a flow-through activated carbon filter that removes chlorine and other impurities, resulting in clean, taste-free and odorless drinking water.

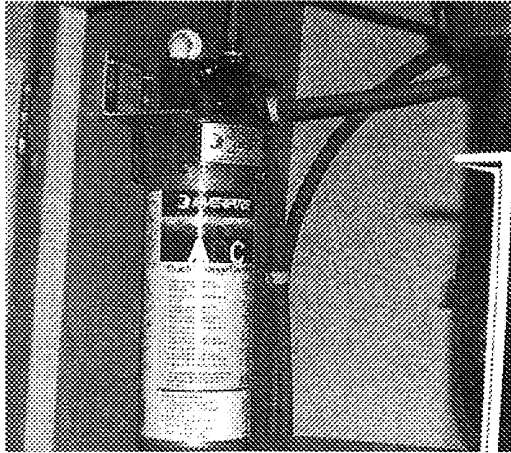

Water Filter Assembly -
Below Galley Sink

Replacing the water filter cartridge:

Replace the filter cartridge when water flow from the purifier faucet is too slow for convenience.

- Place a container beneath the filter to catch any any remaining water during removal.
- Raise the valve handle and turn the colored ring fully clockwise.
- Twist the filter cartridge counterclockwise about a quarter-turn and pull it down and out of the filter head.
- Raise the valve handle and turn the colored ring fully clockwise.
- Insert a new water filter cartridge up into the filter head as far as possible and turn it clockwise a quarter-turn.
- Turn colored ring fully counterclockwise to lock the filter cartridge in position between the head and colored ring.
- Lower valve handle to lock colored ring in place.

See “Winterizing the Water Purifier System” in Section 10.

SHOWER HOSE VACUUM BREAKER

After using the shower, you may notice water dripping from the shower faucet assembly. The dripping results when vacuum in the shower hose (after closing the shower faucet) slowly releases and allows water remaining in the hose to drain down. This is a normal function of the shower valve assembly and is not a leak or defect.

The International Association of Plumbing and Mechanical Officials Standard TSC 21-85 (PAR. 4.3) states:

“Shower heads which incorporate shutoff valves, shall have a minimum “drip rate” of one (1) quart in thirty (30) minutes.”

CAUTION

If items are placed into the shower tub before shower valve vacuum release is complete, they may become wet.

The label shown below is attached on or near the faucet to explain the operation of the vacuum breaker assembly.

For your protection, this faucet is equipped with a vacuum breaker (back flow preventer) to prevent contamination of your potable water supply. The water in the hand held shower hose will drain through this vacuum breaker when the faucet is turned off. This is not a leak. This drainage is inherent in the design of the vacuum breaker, and is evidence that it is functioning properly.

P.P.I. 0387

EXTERIOR SHOWER

The exterior auxiliary shower feature allows you to do things such as rinse off sand or salt after a swim, rinse off muddy boots, or bathe your pet outside the coach. It is located in the utility system compartment.

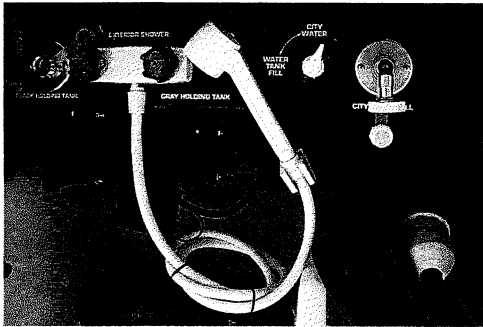

For your convenience, a water pump switch is located near the shower knobs. This allows you to turn the pump on or off from outside the coach.

The exterior shower also doubles as a water line drain valve. See drain valve locations on page 7-8 for further information.

WASTE WATER SYSTEM

The drainage system is self-contained, allowing use of the toilet, sinks, or shower even in areas where hook-up is not available. The drainage system has two holding tanks which hold the gray (waste) water and black (sewage) water.

The holding tanks are dumped through a common outlet located inside the utility compartment on the left side of the coach, ahead of the rear wheels.

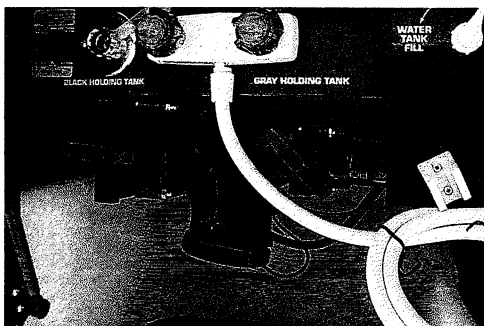

DUMPING HOLDING TANKS

1. Remove drain hose from exterior storage compartment.
2. Remove dust cap from drain and connect drain hose. Be sure it is firmly attached.
3. Place the other end of sewer hose into disposal opening.
4. Open the the black water valve with a quick

pull and make sure there are no sags in the hose. Move the hose gently about to dislodge any waste and ensure complete drainage. Close black water valve as soon as tank is empty.

NOTE: Do not open the gray water valve until the black water tank is drained and dump valve closed to avoid sewage back-up into gray tank. Gray water also rinses any black water solids from the drain hose.

5. Open the gray water valve. Be sure there are no sags in the hose to ensure complete drainage. Close gray water valve as soon as tank is empty.
6. After both tanks have been drained, run several gallons of water into the sewage tank through the toilet. Then open sewage dump valve and drain the tank again. Close valve and replace dust cap securely.
7. It is advisable to add an odor control chemical to the sewage holding tank. These chemicals are available at most R.V. stores.
8. Rinse sewer hose thoroughly with water and stow.

NOTE: We recommend that you dump all holding tanks before traveling to avoid carrying unnecessary weight.

Flushing your Black Water Holding Tank

The black water holding tank is equipped with an internal flushing head to allow you to rinse the inside of the tank with clean water after dumping.

1. Dump your black water holding tank in the usual manner at approved sewage disposal station.
2. Leave black water dump valve open while flushing tank.
3. Attach a garden hose from a city water hydrant to the Flushing System inlet fitting near the black water dump valve. (This inlet is clearly marked separate from the City Water inlet.)
4. Turn the water on to begin flushing; allow water to run for about three minutes.

SECTION 7 PLUMBING SYSTEMS

Sunflyer

5. Disconnect hose from flushing system fitting and close dump valves.

USING ON-SITE SEWER HOOK-UPS

The drain hose may remain attached to the dump outlet and be routed out the bottom of the compartment while the motor home is parked and connected to an on-site sewage hook-up.

When using a sewer hook-up, keep the dump valves closed until a tank becomes full or when preparing to leave the site. This keeps the solids in suspension, allowing them to be carried out with the liquids when the dump valve is opened. If the valve is left open, the liquids will drain off, leaving solids in the tank. Should this accidentally happen, disconnect the hose, fill the tank about half full with water, and drive a few miles to dislodge the solids. A few starts and stops will aid in the process. Then reconnect the hose and drain in the normal manner.

UTILITY LIGHT

A lamp is located up on the left sidewall to provide light in the utility hook-up area.

The switch is located inside the utility system compartment on the left side of the coach.

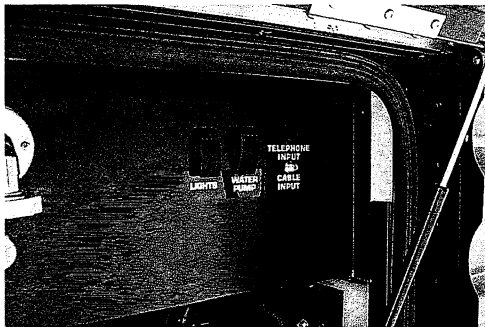

HOLDING TANK LEVEL INDICATORS

The holding tanks may be monitored on the wall mounted monitor center.

Press the "Levels Test" switch to check the level in each tank.

See pages 8-8 for further information on the monitor panel.

WATER DRAIN VALVES

The water drain valves are used to drain water from the water tank and the water supply lines when preparing the motor home for storage or when sanitizing the water system.

To open or close the drain valves, turn the handles in the directions indicated by the following illustration.

Drain valve locations are listed on the following pages.

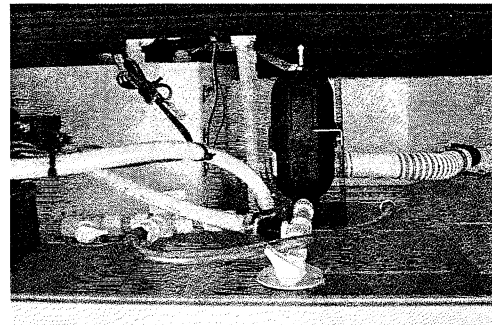
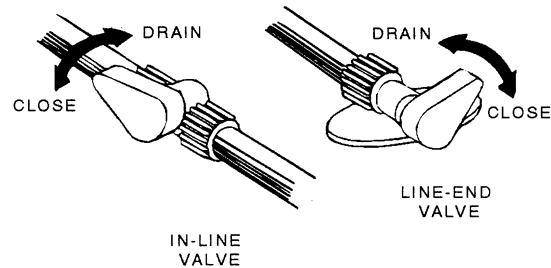

Models built on Freightliner diesel pusher chassis: The tank drain valve is operated by a remote cable/handle labeled and located near the sewage drain valve handles.

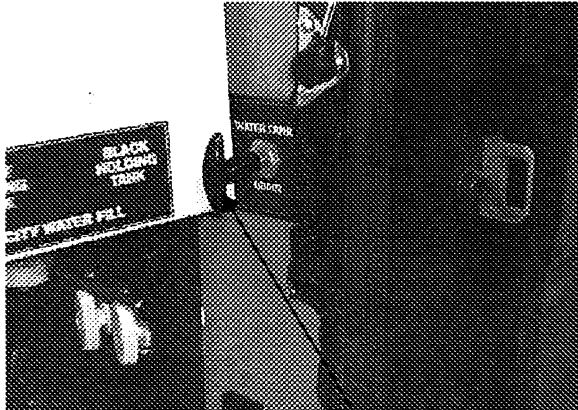

Water Tank Drain Valve -
Model 36WL Freightliner
Diesel

HOLDING TANK CAPACITIES

Model 33WB

- Tank 1 - Black (Toilet)55 gal.
- Tank 2 - Gray (Galley, Shower & Lavatory)53 gal.

Model 34WY

- Tank 1 - Black (Toilet).....55 gal.
- Tank 2 - Gray (Galley, Shower, & Lavatory)..... 53 gal.

Model 35WH

- Tank 1 - Black (Toilet & Lavatory)..... 55 gal.
- Tank 2 - Gray (Galley & Shower) 53 gal.

Model 36WL

- Tank 1 - Black (Toilet).....55 gal.
- Tank 2 - Gray (Galley, Shower & Lavatory)..... 53 gal.

WATER SYSTEM DRAIN VALVE LOCATIONS		
MODEL	SYSTEM	DRAIN VALVE LOCATIONS
33WB 34WY	Water Lines:	Hot and Cold water lines: One (1) valve near the water tanks in the rear cargo compartment on the passenger side of the coach. Open exterior shower faucet valves and lay shower head on ground to drain exterior shower line. Also the tip of your finger inside the city water connection and gently press the backflow valve (small “button” in center of connector) to drain any water left in the city water line.
	Water Tank:	One (1) valve near the water tank in the rear cargo compartment on the passenger side of the coach.
	Water Heater:	Drain plug on outside of coach, behind service door. Use socket to remove drain plug.
	Water Heater By-Pass Valve:	Located behind a removable black access panel beneath the galley sink cabinet.
	Winterization (Antifreeze) Valve:	Near the water tanks in the rear cargo compartment on the passenger side of the coach.
35WH	Water Lines:	Hot and Cold water lines: One (1) valve near the water tanks in the rear cargo compartment on the driver side of the coach. Open exterior shower faucet valves and lay shower head on ground to drain exterior shower line. Also place the tip of your finger inside the city water connection and gently press the backflow valve (small “button” in center of connector) to drain any water left in the city water line.
	Water Tank:	One (1) valve near the water tank in the rear cargo compartment on the passenger side of the coach.
	Water Heater:	Drain plug on outside of coach, behind service door. Use socket to remove drain plug.
	Water Heater By-Pass Valve:	Located in bottom of right rear wardrobe, beneath removable bottom shelf.
	Winterization (Antifreeze) Valve:	Near the water tanks in the rear cargo compartment on the driver side of the coach.

36WL	Water Lines:	Hot and Cold water lines: Valves located in water/drainage compartment on driver side of coach. Open exterior shower faucet valves and lay shower head on ground to drain exterior shower line. Also place the tip of your finger inside the city water connection and gently press the backflow valve (small "button" in center of connector) to drain any water left in the city water line.
	Water Tank:	Valve located in water/drainage compartment of driver side of coach. <i>Chevy or Ford chassis:</i> Turn the valve knob as shown in the previous illustration. <i>Freightliner diesel chassis:</i> Pull out small T-handle valve in water/drainage compartment. Push handle back in to close valve as soon as tank is drained.
	Water Heater:	Drain plug on outside of coach, behind service door. Use socket to remove drain plug.
	Water Heater By-Pass Valve:	Under galley sink cabinet.
	Winterization (Antifreeze) Valve	<p>In the middle cargo compartment on the passenger side of the coach.</p> <p>To properly winterize the shower, you must drain the line which runs from the shower faucet valves to the corner spout. A drain valve is located behind the vent panel in the aisle side of the shower base cabinet. Remove the screws to remove the vent, then turn the valve as shown in the illustration.</p>

(See also Safety Precautions, Section 1 of this manual.)

NOTE: Because this model is available in several sizes and floor plans, some items described may be optional or unavailable on your coach.

The appliances installed in your motor home are manufactured by reputable RV appliance makers and have been tested by independent laboratories to meet all applicable standards and codes set for RV appliances. These appliances are covered by your New Vehicle Limited Warranty. (Certain items may be covered by individual manufacturer's warranty.) See your New Vehicle Limited Warranty for details.

REFRIGERATOR

The refrigerator in your coach can be operated from either of two power sources available to the motor home:

- 110-Volt AC electric
- LP gas

The refrigerator is an absorption type which uses an ammonia-water solution for cooling. Basically, ammonia vapor is distilled from the solution by heat, produced from either LP gas or electricity and then carried to the finned condenser where it liquefies. The liquid then flows to an evaporator where it creates cold temperatures through evaporation.

LEVELING

Before operating the refrigerator when the motor home is stationary, place a small level on the freezer plate and make certain the unit is level.

CAUTION

To prevent permanent damage to the refrigerator cooling unit, turn the refrigerator off if the vehicle will be parked on an incline of over 3° side-to-side or 6° front-to-rear (such as steep driveways or parking lots, etc.) for more than one hour.

Normal vehicle leveling to provide comfort for the occupants is satisfactory for refrigerator operation. This will be well within the operation limits of 3° off-level side-to-side and 6° off-level front-to-back.

OPERATING INSTRUCTIONS

Norcold Model 900-Series Models with Electronic Auto Mode Control

Start-Up Instructions - Gas Mode

The control panel is located between the freezer compartment and fresh food compartment. It contains pressure sensitive touch switches and LED display. The AC, LP GAS, Battery, and AUTO LED's (A) illuminate to indicate the refrigerator's operating mode.

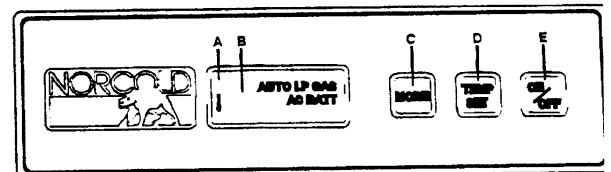

The ON/OFF button (E) turns the refrigerator On or Off. If the button is pressed, it will turn the refrigerator On and set the mode to AUTO. When the refrigerator is On, pressing this button for 2 seconds will turn the refrigerator Off.

Pressing and holding the MODE button (C) allows the user to cycle through the three mode choices; one AUTO and two manual modes (AC, LP GAS). The refrigerator will not switch to the new operating mode until the mode button is released.

The TEMP SET (thermostat) button (D) controls the refrigerator and freezer temperature during both gas and electric operation. Press and hold the TEMP SET button to select the desired temperature setting. The temperature settings are shown in the form of LED's (A). The illuminated LED indicates the temperature setting, with COLD on the left and COLDEST on the right. The temperature LED turns off after 10 seconds. Quickly press and release tempset button to display the temperature setting.

Start-Up Instructions - Auto Mode

When the AUTO mode is selected, the operating control automatically selects the power source using the following priority scheme:

- When 120 volts AC is available to the refrigerator, the AUTO LED and the AC LED will illuminate, indicating the refrigerator is operating on AC electric. After 10 seconds, the AC LED will turn off and only the AUTO LED will remain illuminated. Press and quickly release mode button to display the operating mode.
- If 120 volts AC is not available, the refrigerator will switch to the gas operation. The AUTO LED and the LP GAS LED will illuminate. After 10 seconds, the LP GAS LED will turn off and only the AUTO LED will remain illuminated. Press and quickly release mode button to display the operating mode.

During operation in the AUTO mode, when a higher priority power source becomes available, the operating controls will cease using the current power source and will switch to the higher priority power source. For example, if AC electric becomes available while the refrigerator is operating in the AUTO LP GAS mode, the refrigerator will switch to AUTO AC operation.

If an operating mode is not functional, its corresponding LED will flash and the refrigerator will attempt to operate in a lower power priority source. If a lower power priority source is not available, the LED will continue to flash, and the refrigerator will cease operation until the

energy source is corrected. Refer to the "Diagnostic" section on page 7 of the "Norcold 9100 Series Refrigerators Operator's Guide" in your blue binder.

Start-Up Instructions - Manual Mode

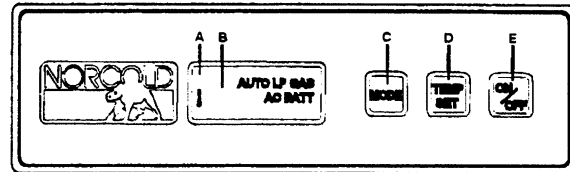

To operate the MANUAL mode, press and hold the MODE button (C) until the AUTO LED disappears and the desired operating mode is displayed. If the power source is interrupted while operating in the MANUAL mode, the AUTO LED disappears and the desired operating mode is illuminated. Unlike AUTO mode, the operating mode LED remains illuminated until an alternate mode is selected. If the energy source is interrupted while in the MANUAL mode, the corresponding LED flashes, and the refrigerator ceases operation until an alternative energy source is selected or the problem is corrected. Refer to the "Diagnostics" section on page 7 of the Norcold Operator's Guide in your blue binder for corrective actions.

AUTO and MANUAL Modes - Gas Operation Only

If the gas does not ignite within 30 seconds, which may occur on initial start-up, the refrigerator's gas valve will automatically close and the operating controls will select an alternate power source (AUTO Mode) or revert to a stand-by mode in which the LP GAS LED flashes. The LED continues to flash until the refrigerator is turned OFF and then ON. If the gas does not ignite after several attempts, check the input gas supply, or consult with your dealer or a Norcold authorized service center. A different mode of operation may be selected by pressing and holding the MODE button. The refrigerator will not switch to the new operating mode until the MODE button is released.

Backup Operating System (“BOS”)

Your refrigerator features a Backup Operating System which keeps the refrigerator cool in the event of a failure of the refrigerator’s operating controls. If a failure occurs, the TEMP SET LED flashes and refrigerator switches to the BOS mode. This mode provides refrigeration until the refrigerator is serviced. The fresh food and freezer compartment temperatures should be monitored to prevent over-freezing or thawing of refrigerator contents when operating in the BOS mode. If the refrigerator temperature is too cold, adjust the thermostat to the left in single LED increments. If the refrigerator temperature is too warm, adjust the thermostat to the right in single LED increments. Let the refrigerator operate at the new setting for one hour before rechecking the freezer and fresh food compartment temperatures. (Frequent door opening prevents the temperatures from stabilizing.) Although the refrigerator can operate in this mode, Norcold recommends that you seek service to restore manual operation as soon as practical.

Operating Tips

- The refrigerator should already be cold before placing items in it.
- Food and beverages should also be cold before placing in RV refrigerator. Never put warm or hot items in a cold refrigerator.
- Do not pack the refrigerator too full. The refrigerator needs room for cold air to circulate.
- Use smaller containers for each item. (e.g. a half gallon container of milk instead of a half-full gallon jug)
- Always put foods, especially liquids, in tightly sealed containers.
- Use crumpled paper between loose items to reduce rattling or “clinking” noises.

Further Information

For further information and operating cautions, see the Norcold refrigerator operating in-

structions included either inside the refrigerator or in your Motor Home Operations Manual binder.

WARNING

Most LP gas appliances used in recreational vehicles are vented to the outside of the vehicle. When parked close to a gasoline pump, it is possible that the gasoline fumes could enter this type of appliance and ignite from the burner flame, CAUSING A FIRE OR AN EXPLOSION.

FOR YOUR SAFETY, it is recommended that all LP gas appliances which are vented to the outside should be shut off when refueling.

How to Use the Refrigerator**Food Storage Compartment**

The food storage compartment is completely closed and unventilated, which is necessary to maintain the required low temperature for food storage. Consequently, foods having a strong odor or those that absorb odors easily should be covered. Vegetables, salads, etc. should be covered to retain their crispness. The coldest positions in the refrigerator are under the cooling fins and at the bottom of the refrigerator. The warmer areas are on the upper door shelves. This should be considered when placing different types of food in the refrigerator.

When the refrigerator is heavily loaded, it will take a longer time to lower the temperature; therefore, to get maximum efficiency the refrigerator and food items should be pre-cooled prior to loading. The shelves should not be covered with paper or plastic, and the food items should be arranged so air can circulate freely.

Frozen Food Storage Compartment

Quick frozen soft fruits and ice cream should be placed in the coldest part of the compartment, which is on the top freezer shelf. Frozen vegetables may be stored in any part of the compartment.

SECTION 8
APPLIANCES & INTERIOR FEATURES

Sunflyer

This compartment is not designed for deep or quick freezing of food. Meat or fish, whether raw or prepared, can be stored in the frozen food storage compartment provided they are pre-cooled first in the refrigerator. They can be stored about three times longer in the frozen food compartment as compared to the fresh food compartment. To prevent food from drying out, keep it in covered dishes, containers, plastic bags or wrapped in aluminum foil.

Ice Making

Ice cubes can be made in the ice trays placed in the freezer compartment. The trays should be filled with water to within 1/4" (5 mm) from the top. For faster ice making, the trays should be placed in direct contact with the freezer shelves.

To release the ice cubes, seize the tray with both hands and twist the tray. Cubes not required should be replaced in the tray. Refill the tray with water and replace the tray on the freezer shelf.

Ice will be made more rapidly if the thermostat is set at its highest position.

It is a good idea to do this a few hours before the anticipated need for ice, but be sure to move the thermostat back to normal setting, usually about mid setting when the ice is formed. Food in the lower compartment may be frozen if the setting is left on "COLDEST" position.

Defrosting

Shut off the refrigerator by pressing the main power ON/OFF button to the (OFF) position.

Empty the refrigerator, leaving the drip tray under the finned evaporator, and the cabinet and freezer doors open. Defrosting time can be reduced by filling the ice trays with hot water and placing them on the freezer shelves.

When all the frost has melted, dry the interior of the refrigerator and freezer with a clean cloth. Replace all food and set the thermostat to the COLDEST temperature setting for a few hours. Then reset the thermostat to the desired setting, usually at mid setting.

CAUTION

DO NOT use a hot air blower. Permanent damage could result from warping the metal or plastic parts. DO NOT use a knife or an ice pick, or other sharp tools to remove frost from the freezer shelves. They can create a leak in the ammonia system.

Cleaning

Cleaning the refrigerator is usually done after it is defrosted or put into storage. To clean the interior liner of the refrigerator, use lukewarm weak soda solution. Use only warm water to clean the finned evaporator, ice trays and shelves. NEVER use strong chemicals or abrasives to clean these parts as the protective surfaces will be damaged. It is important to always keep the refrigerator clean.

Shut Off - Storage Procedure

Shut off the refrigerator by pressing the main power ON/OFF button to the (OFF) position.

If the refrigerator will not be in operation for a period of weeks, it should be emptied, defrosted, cleaned and the doors left ajar. The ice trays should also be dried and kept outside the cabinet.

CAUTION

DO NOT store explosive substances in the refrigerator, such as cigarette lighter gas, petrol, ether or the like.

NOTE: The climate control will draw 12 volts DC power continuously when in the ON position. It should be turned OFF when a charging source is not available.

REFRIGERATOR COMPARTMENT

(Exterior)

The exterior refrigerator compartment allows access to the rear of the refrigerator for inspection, maintenance and service.

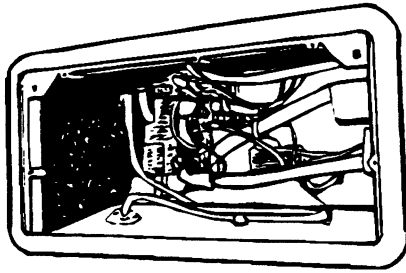

Refrigerator Access Compartment

To Open:

1. Use a coin to turn the latch knobs to the vertical position as shown.
2. Remove the door from the opening.

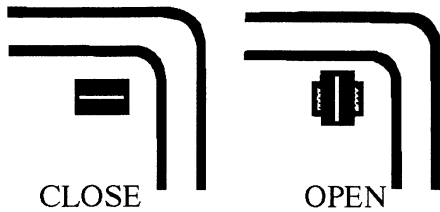

Refrigerator Access Door Latches

To Close:

1. Replace the door into the opening.
2. Push the latch knobs in while turning to the horizontal position as shown.

RANGE AND OVEN

The range and oven in your motor home are operated on LP gas and will provide nearly all of the functions that the range in your home does. One benefit of gas burners is that heat is available as soon as a burner is lit, as opposed to an electric element slowly heating up. The range has a "Pilot Off" position on the oven control which allows the oven pilot to be turned off when traveling or refilling the LP tank.

The following warning label has been located in the cooking area to remind you to provide an adequate supply of fresh air for combustion.

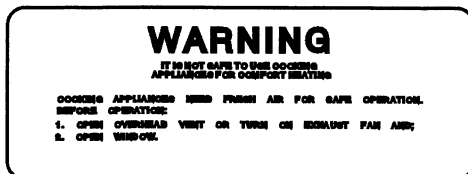

Unlike large homes, the oxygen supply inside a recreational vehicle is limited due to its size. To avoid danger of asphyxiation, provide proper ventilation when using the gas rangetop or gas oven. It is especially important not to use the gas oven and range top for comfort heating. Danger of asphyxiation is greater when these appliances are used for long periods of time.

WARNING

Portable fuel-burning equipment including wood and charcoal grills and stoves, should not be used inside the recreational vehicle. The use of this equipment inside the recreational vehicle may cause fires or asphyxiation.

Using Range Top Burners

1. Rotate the Spark knob clockwise to provide ignition spark.
2. While rotating the Spark knob, turn the selected Burner knob to ON.
3. When the burner lights, release the Spark knob and turn the Burner knob to adjust the flame height.

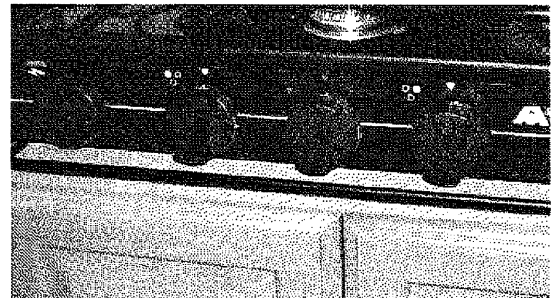

WARNING

Do not turn burner control knob to "On" and allow gas to escape before operating spark ignition or lighting match.

Lighting Oven Pilot

NOTE: If range has not been operated for a long period of time, a longer waiting period for ignition of the pilot may be necessary due to air in the gas line.

1. Be sure all valves are in the "OFF" Position. The oven control knob should be in "OFF" position.
2. Turn on main gas supply to range.
3. Press and turn control knob to the "PILOT ON" position. This will allow gas to oven pilot.
4. Open oven door and light oven pilot with a match. Small flame will be noted at the

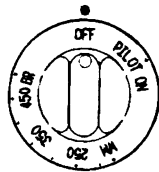

Oven Control Knob in "OFF" position

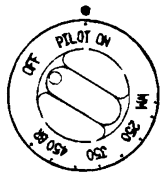

Oven Control Knob in "PILOT ON" position

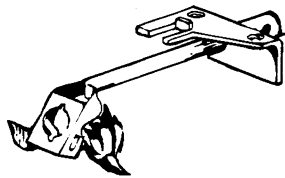

Lighting oven pilot (when pilot is located on left side of burner.)

Operating Oven Control

Push in and turn the oven control knob (counterclockwise) to the desired temperature setting.

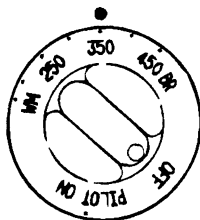

There is a delay of about 45 seconds before the main burner ignites. This is normal and there is no gas escaping during this delay. It is also normal for the oven burner flame to cycle off and on at all temperatures except broil (BR).

Shut Down Instructions

When oven cooking is finished, turn the oven control knob to the "PILOT ON" position, the oven standby pilot will remain lit.

When the recreational vehicle is not in use or while traveling, turn the oven control knob to "OFF" position and turn off main gas supply; this will turn off the oven pilot.

MICROWAVE OVEN (Optional)

For complete operating instructions, refer to the manufacturer's information provided with the oven.

RANGE HOOD AND MONITOR PANEL

The monitor panel is built into the face of the range hood. It provides central location of switches for the hood fan, hood light, water pump and tank level indicator lights.

The auxiliary electric generator start/stop switch and hourmeter are also located on the range hood panel. See section 6 for generator starting and stopping instructions and operating precautions.

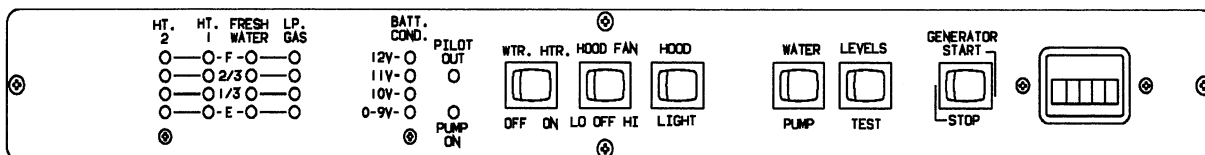
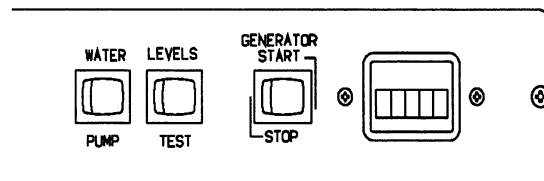

Range Hood Monitor Panel

At the push of a single button this monitor panel simultaneously displays the coach battery condition and levels of the water tank, holding tanks and LP tank. It also contains the water pump power switch and an indicator light to show when the pump switch is on.

Water and Holding Tank Levels

Press and hold the “Levels Test” switch to show approximate level on the monitor lights.

Approximate levels of the fresh water and holding tanks are measured by sets of electronic probes in the sides of the tanks. The liquid must be at or above a probe to illuminate the indicator lights to a given level.

For example, a water level of 1-2” above the 1/3 probe would register as only 1/3 full. Consequently, a level of merely 1” below the 1/3 probe would register empty. Generally speaking, there is actually more liquid in a tank than indicated.

Tank Capacities

See back of “To The Owner” page inside front cover of this manual.

LP Gas Level

Press and hold the “Levels Test” switch to show approximate LP tank level.

The LP level is registered by a sending unit on the tank. The gauge mounted on the side of the tank will give a more accurate indication of actual tank level if needed.

Water Pump Switch

When use of the self-contained water system is desired, turn the “Water Pump” switch on. The “Pump On” light will illuminate when the pump switch is on and the system is operable. Water will be available as soon as a faucet is opened. Refer to “Fresh Water System” for additional information on the water pump and initial start-up.

Generator Start/Stop Switch

See Section 6, Electrical Systems for generator start-up and shut-down instructions.

Generator Hourmeter

See Section 6, Electrical Systems for generator hourmeter information.

Battery Condition Meter

Push the “Levels Test” button to check the level of charge (voltage) in the 12-volt coach battery. The colored segments (red, yellow and green) will light from the bottom up to the amount of charge the battery contains.

- * Green - good or adequate charge.
- * Yellow - marginal charge.
- * Red - battery needs charging before use.

To get an accurate reading;

1. Both the chassis engine and the auxiliary generator engine must be shut off.
2. An interior light should be turned on to provide a small load which draws off the battery surface charge.

WATER HEATER

Direct Ignition Model

1. Place Water Heater switch in the “On” position. The switch and “WH Pilot” light are located on the lower face area of the galley cabinet.
2. If “W.H. Pilot” light stays on longer than 15 seconds, place switch in “Off” position and wait 5 minutes.
3. Repeat step one.
4. If heater fails to operate due to high water temperature, the heater will go into a lockout condition (“W.H. Pilot” light on). When water cools, reset by placing switch in “Off” position for at least 30 seconds, then return to “On” position.
5. If a lockout condition persists: contact your dealer, an Atwood Service Station or Atwood Service Department (Phone: 815-877-5700).
6. For complete shut-down before servicing:
 - a) Place Water Heater switch in “Off” position.
 - b) Remove red wire from left-hand terminal of ECO switch (ECO to valve).

Water Heater Switch and “W.H. Pilot” Indicator

Be sure the water heater is filled with water before pressing this switch. To fill the water heater, turn the water pump switch on and open a hot water faucet until water begins to flow.

SECTION 8
APPLIANCES & INTERIOR FEATURES



The “W.H. Pilot” light will glow for about 10-15 seconds after the water heater switch is turned on, then it will go off.

If the “W.H. Pilot” light comes on during normal operation, it means that the burner has gone into “lockout” mode. Turn the switch off for about 5 minutes, then turn back on.

Water Heater Capacity: 6 gal.

Pressure-Temperature Relief Valve

On occasion, water may be seen seeping from the water heater pressure temperature relief valve. This is no cause for repair or replacement of the valve.

P-T Relief Valve

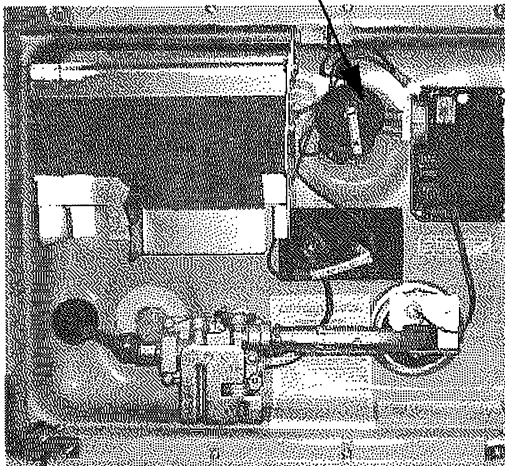

Normally there is an air gap at the top of the water heater tank which acts as a pressure buffer. In time, however, heated water may expand and fill this air gap, causing a slight increase in water pressure. This may cause the P-T valve to “weep” until the air gap is manually replaced.

OPERATE THIS VALVE ONLY WHEN THE WATER HEATER AND COOLING SYSTEM ARE COLD!

To Replace the Air Gap:

1. Turn off the water heater switch and incoming water supply (city water and/or demand pump).
2. Open a faucet in the motor home to relieve water pressure.

3. Pull the handle of the P-T valve straight out and allow water to flow until it stops.

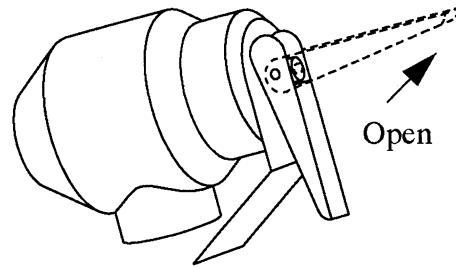

P-T Valve

4. Let the handle of the P-T valve snap shut.
5. Close the faucet and turn on the water supply before switching the water heater on.

Manually operate the pressure temperature relief valve at least once a year.

WATER HEATER BY-PASS VALVE

Your coach may be equipped with a water heater by-pass valve for easier winterization of water lines using RV antifreeze.

The valve is located behind the access panel on the lower face of the refrigerator cabinet.

NOTE: Your coach is not equipped with this valve if you have the optional automatic winterization system

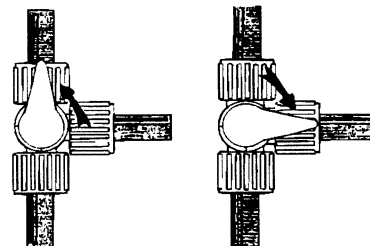

Normal Flow

By-Pass Mode

CAUTION

Leave by-pass valve handle in **NORMAL FLOW** position if draining water and blowing out water lines. Place in **BYPASS** position **ONLY** when using antifreeze solution in water lines.

MOTOR AID

(Not available on Freightliner diesel chassis)

The motor aid uses heat from the chassis engine cooling system to heat water in the water heater while driving. Hoses are routed from the engine to a heat exchanger surrounding the water heater tank.

Under normal conditions, the entire contents of the water heater can be heated to about 140°F in about two hours or 100 miles of driving. This means you can have hot water at the faucets immediately upon arriving at a site, or even while driving if needed.

The motor aid also increases the capacity of the engine cooling system, allowing the engine to run cooler under many conditions.

CAUTION

Any leak in the heat exchanger or its supply or return lines could cause loss of coolant and subsequent engine failure. We recommend that you periodically inspect these connecting lines and the heater to insure that no leaks have developed.

Motor Aid Water Heater and Rear Auxiliary Heater Maintenance

Have your authorized dealer check all hose clamp connections on the rear automotive heater and the motor aid water heater at least every six months and tighten them if necessary.

LP GAS FURNACE (SUBURBAN)

To Start Up:

1. Close the LP gas tank valve.

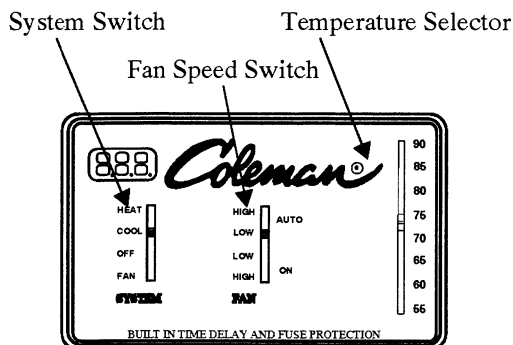

2. Slide thermostat switch from OFF to HEAT.
3. Set thermostat above room temperature to begin blower operation. A slight delay will occur before the blower comes on. Allow blower to run for 5 minutes for combustion chamber purge cycle.

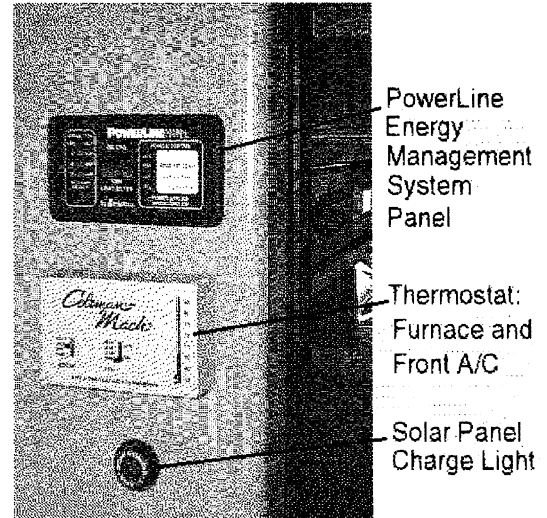

4. After 5 minutes, move thermostat lever below room temperature. Blower will remain on. Wait approximately 2 minutes for blower to go off.
5. Open LP gas tank valve.
6. Set thermostat to desired temperature. If set above room temperature, blower will come on.
7. Allow 30 seconds for main burner to light after blower comes on. This furnace is equipped with an ignition device which automatically lights the burner. Do not try to light the burner by hand.
8. If burner does not light, repeat Steps 1 through 5. (If heat does not come out of the heat duct after a minute or so, the burner is not lit.)
9. If after three (3) attempts with no ignition, go to shut-down and contact your dealer or a local recreational vehicle service center. Do not continue to cycle furnace through thermostat in an attempt to get ignition.

To Shut Down:

1. Slide thermostat switch to OFF position.
2. Close LP tank valve.

NOTE: For normal operation after initial start-up, be sure the thermostat switch is in HEAT position, then place the temperature selector to the desired temperature. The furnace will start and cycle on and off automatically.

For Further Information

Please see the Suburban furnace operating instructions provided in your Owner Information binder for further information, including operating precautions, and periodic maintenance.

DUCTED ROOF AIR CONDITIONING SYSTEM

Front and rear air conditioner units are controlled by separate wall thermostats. The front thermostat is located on a galley wall. The rear thermostat is located in the bedroom.

The front thermostat also controls furnace operation when the SYSTEM switch is placed in HEAT position. (See LP Gas Furnace).

NOTE: The ducted roof air conditioning system has ceiling registers than can be closed if necessary to force more cool air toward a specific area of the coach or to route cool air away from a specific area. If too many vents are closed, however, it can cause the air conditioner unit to ice up and stop cooling, particularly in high humidity conditions.

Operation

Refer to the manufacturer’s information in your Motor Home Operations Manual binder for complete operating instructions and recommended positions for SYSTEM and FAN switches.

NOTE: The ducted roof air conditioning system has ceiling registers that can be closed if necessary to force more cool air toward a specific area of the coach or to route cool air away from a specific area. If too many vents are closed, however, it can cause the air conditioner unit to ice up and stop cooling, particularly in high humidity conditions.

Further Information

See the air conditioner manufacturer’s operating instructions supplied in your Motor Home Operations Manual binder. They contain detailed operating instructions, special precautions and basic troubleshooting.

TV ANTENNA - Optional

The TV antenna on your motor home can be easily raised, rotated a full 360° and lowered from inside the vehicle by simply turning a crank or rotating knob. A built-in signal amplifier designed to strengthen signals, is controlled by a power switch built into the TV jack assembly.

The signal amplifier is housed inside the antenna with the circuit board connected directly to the antenna elements. Power to operate the amplifier (12-volt DC) is supplied through the download cable which also carries the TV signals to the TV set. The power supply separates the 12-volt DC from the TV signals and provides a place for attaching the TV set and the 12-volt power source.

Raising Antenna - Turn elevating crank clockwise in “UP” direction about 13 turns or until some resistance to turning is noted. Antenna is now in operating position. Turn amplifier power switch “ON” to receive TV signal.

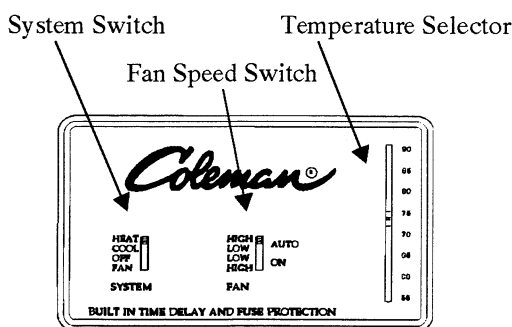



WARNING
Never allow the antenna to touch electrical power lines or any other electrical wires.

Rotating Antenna - Make sure antenna is in the "UP" position. Pull down on rotating knob until it disengages ceiling plate and rotate for best picture and sound on TV set.



Lowering Antenna to Travel Position - Rotate antenna until pointer on rotating knob aligns with pointer on ceiling plate.

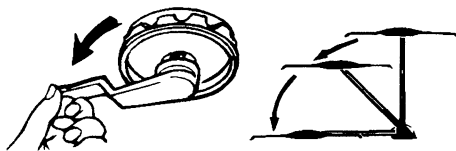

CAUTION
Never leave the antenna partially raised or partially lowered. This can damage the crank mechanism gears. Always raise the antenna straight up or lower it completely into the travel position.

Turn elevating crank (counterclockwise) in "DOWN" direction until resistance is noted. Antenna is now locked in travel position. Turn amplifier power switch "OFF".

Count the number of turns needed to crank the antenna down to the roof of the unit (normally about 13). Mark the final position of the crank handle on the ceiling or the directional knob for

reference. Also mark the number of turns needed. Use the mark and number as a reference whenever you lower the antenna.

CAUTION
Always align directional handle to "DOWN" position before lowering.

SIGNAL AMPLIFIER

The amplifier power switch is located on a TV jack plate in the front overhead cabinet above the driver and passenger seats.

To operate amplifier, turn on power switch.

A red indicator light will glow while the signal amplifier is in use.

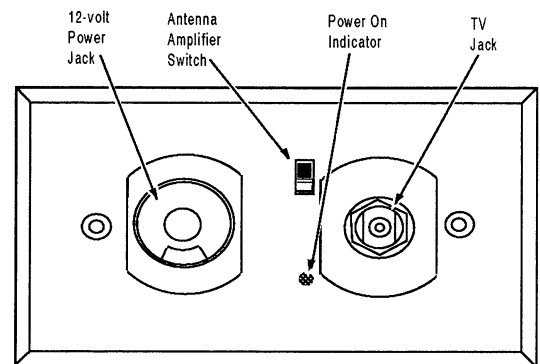

Other TV jack plates are mounted in various locations throughout the coach. Some of these wall plates are not readily visible and may be in one of the following locations.

- In the entertainment center on the outside of the coach.
- In the bedroom area.

Checking Signal Performance

The TV signals available to an RV are entirely dependent on its location in relation to the transmitter. Signals may vary from strong to no usable signal at all. We recommend that the TV system be checked out in an area known to have good TV reception.

To check the antenna amplifier, raise the antenna, select a TV channel and rotate the antenna for best picture. Then turn off the amplifier power switch. If the antenna amplifier is working properly, the TV picture will now be degraded

SECTION 8 APPLIANCES & INTERIOR FEATURES

Sunflyer

(snowy). When you turn the switch back on, the picture should again be sharp.

PHONE AND CABLE TV-HOOK-UPS

Some models are equipped with external connections for telephone and cable television. The connectors are located in the shoreline cord/sewage dump compartment.

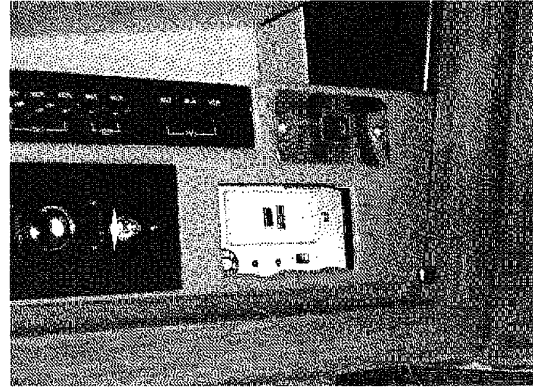
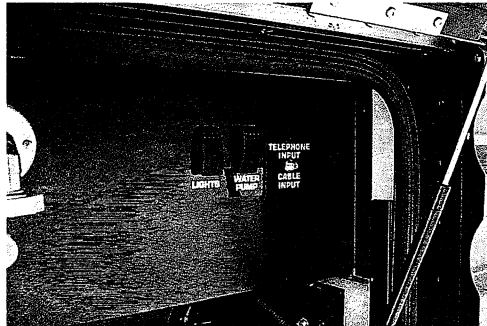

Components

TV1 = Front TV

TV2 = Bedroom TV

VCR = Videocassette Recorder

Signal Inputs:

ANT - Press to connect selected TV or VCR to the roof antenna.

AUX - Press to connect selected TV or VCR to cable TV input.

VCR - Press to connect selected TV to the video-cassette recorder/player.

NOTE: For coaches without the video control center option, be sure the TV antenna amplifier switch is turned OFF while connected to cable.

VIDEO CONTROL CENTER - Optional

The optional video control center allows you to switch the antenna, cable TV or VCR signal to any TV set location in the coach.

This means one person can watch a ball game coming in on the roof antenna on the bedroom TV while another person watches a cable TV program or a video tape on the VCR on the front TV. Also, two people can watch different programs on the two TV's while taping a third program on the VCR.

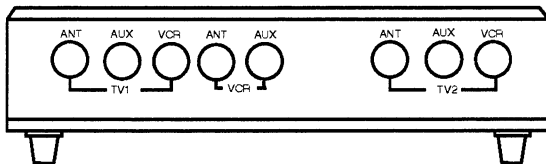

SATELLITE TELEVISION SYSTEM - Optional

The Satellite Television System allows you to receive TV programs directly from satellite to your coach. The programs are transmitted in digital format so the quality is equal to laser disc or CD.

See your **Winegard RV Digital Satellite Antenna System Owner's Manual** for instructions about aiming the satellite antenna dish. The coach must be level before attempting to aim the antenna dish.

See your **Satellite Receiver User's Manual** for instructions about setting up the receiver and remote unit.

We recommend that you **read** both of these manuals **thoroughly** to understand the system completely before attempting any setups or adjustments.

Digital Satellite Operation through the Video Control Center: Press the AUX switch to connect the TV to the DSS system. The satellite system is hooked through the AUX input of the video control center.

DC-AC ELECTRICAL VOLTAGE

INVERTER - Optional

The voltage inverter is located in the overhead video center compartment above the driver or passenger seat. It changes 12 volt DC current into 110 volt AC current to operate your front TV and VCR while traveling or when shoreline hookup is not available.

- The inverter must be switched on to operate.
- Turn the inverter off when not in use to avoid draining the coach or automotive batteries.

EXTERIOR ENTERTAINMENT CENTER

The exterior entertainment center contains a stereo radio/cassette or CD player and convenient TV hook-ups for your outside listening or viewing pleasure.

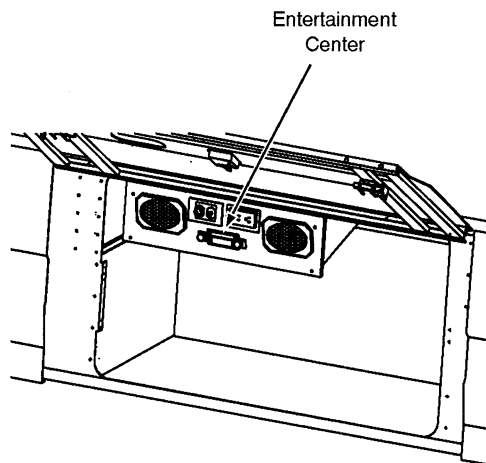

AUDIOVOX® BEDROOM RADIO

The bedroom is equipped with a built-in stereo radio system in the left rear nightstand cabinet. This radio features AM/FM stereo radio with electronic seek/scan tuning, auto reverse cassette player/recorder with music search.

See the Audiovox operator guide in your Operations Manual binder for full operating instructions by the manufacturer.

SLEEPING FACILITIES

WARNING

Do not use sleeping facilities while vehicle is moving.

COUCH BED CONVERSION

To Convert Couch to Bed:

Pull the front edge of the couch seat upward and outward from the wall while gently pushing downward on the backrest until the cushions lie flat. The bed is now ready for use.

To Revert to Couch:

Push the front edge of the seat toward the wall while lifting upward on the backrest until the couch is fully seated against the wall.

DINETTE/BED CONVERSION

To Convert Dinette to Bed:

1. Release the catch on the table leg brace and fold the leg up against the bottom of the table.

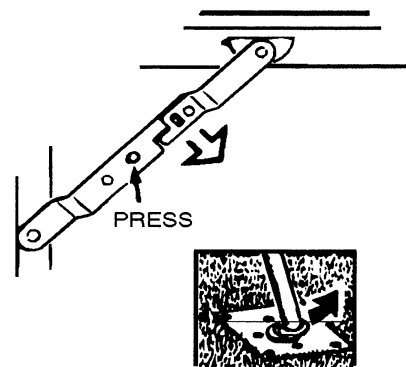

2. Remove the table from the wall support bracket by lifting the end of the table. Then lower the table to rest on the cleats attached to each dinette bench.
3. Arrange dinette cushions to cover bed area.

To Revert to Dinette:

1. Replace the table onto the wall support and lower the table leg.
2. Make sure that the table leg is secured into the floor support bracket and the leg brace is locked.

FRESH WATER TOILET

The fresh water toilet in your motor home is very similar to the household type, except that it is designed to use only a small amount of water per flush. It uses a high velocity jet of water, producing a swirl effect, to efficiently cleanse the bowl. And since each flush uses fresh water, no special chemicals are required other than a deodorizing agent, if necessary.

Thetford Toilet

1. Press the large (left) pedal and hold until bowl is clean. Release pedal slowly. A small amount of water will remain in the bowl.
2. To add more water to the bowl than the normal 2" automatic refill, press the small (right) pedal and hold until desired amount has been added. Release pedal slowly.

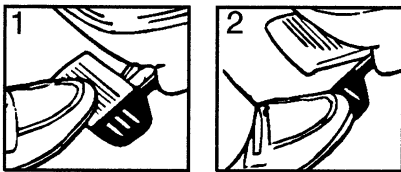

Please refer to the manufacturer's information supplied with the toilet for further operating and maintenance instructions.

SeaLand Toilet

1. To add water to the toilet before using, lift the flush lever until the desired water level is reached. Generally, more water is required only when flushing solids.

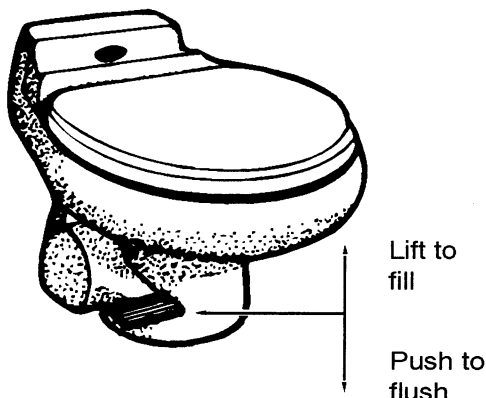

2. To flush the toilet, push the lever all the way down until sewage leaves the toilet and bowl is rinsed clean.
3. Release the flush lever. A small amount of water should remain in the bowl.

Please refer to the manufacturer's information supplied with the toilet for further operating and maintenance instructions.

Important "Don'ts"

- Don't use facial tissue or regular toilet tissue in the RV toilet. These will not disintegrate sufficiently and will often cling to the sides of the holding tank. Toilet tissue made specifically for use in RV toilets and holding tanks is available at most RV supply centers.
- Don't dispose of sanitary napkins or other non-dissolving items in the toilet.
- Don't put automotive antifreeze or caustic chemicals, such as laundry bleach or heavy detergents into the toilet or holding tank. These products may damage plastic or rubber parts in the system.

CLEANING THE TOILET

The toilet should be cleaned regularly for maximum sanitation and operating efficiency. If an odor is apparent from the toilet:

1. Clean the toilet bowl with a mild bathroom cleaner. Do not allow cleaners to set in the bowl for long periods of time to avoid damaging the seals. Do not use caustic or abrasive cleaners because it may damage the plastic surfaces.
2. Dump and rinse holding tank.
3. Add odor control chemical in amount specified after cleaning and every few days during use.
4. Remove the water line from the base of the toilet and clean the screen.
5. If the flush valve becomes stiff after extended use, it may be lubricated with a silicone spray. Turn the water pump off and operate flush pedal to drain water from the toilet bowl. Spray silicone lubricant onto flush valve inside bowl and operate flush pedal a few times to ensure free operation.

See instructions in Section 10 to prepare the toilet for storage in freezing conditions.

POWER ROOF VENT - Bath Area

Your coach is equipped with a powered roof vent in the bath area. A push button switch for the vent fan is located up on the vent. The vent dome can be raised and lowered using the crank handle, or may be powered by a switch on the wall.

CRANK-OUT SIDE WINDOWS

Turn the crank-out knob clockwise to open window; counterclockwise to close. Do not use excessive force on the knob to open or lock into closed position. This could cause permanent damage to the crank mechanism.

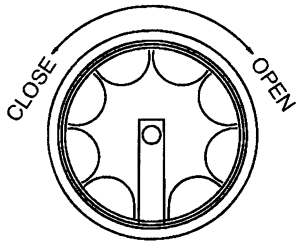

If the window will not open after three or more full turns of the knob, the glass may be stuck to the sealing gasket. Go to the outside of the coach and gently free the glass with your fingers. A periodic light dusting of talcum powder on the gasket should prevent this from recurring.

SLIDER WINDOWS

Lift the latch handle straight out from the window. Grasp the sliding window edge frame and slide the window to the side. Be sure the latch is raised before trying to slide the window closed.

DAY/NIGHT PLEATED WINDOW SHADES

The pleated window shades are dual function shades that can be used for daytime or nighttime privacy.

Sun Filter: The first, lower section is a translucent white shade that can be lowered for privacy without darkening the inside the coach. It can also filter out harsh direct sunlight to help keep the inside of the coach cool in summer or to disperse light for houseplants.

Darkening Shade: The second, upper section is an opaque, darkening shade for nighttime privacy and daytime room darkening purposes. Pull both the first and second sections down together or separately.

Tension Adjustment:

The tension of the pleated shades can be adjusted if they become loose and will not stay up when raised, or they are too tight and are difficult to raise and lower.

To tighten the tension, simply wrap the lower end of the guide cords (on each side of the shade) a few turns around the spools at the lower corners of the shades.

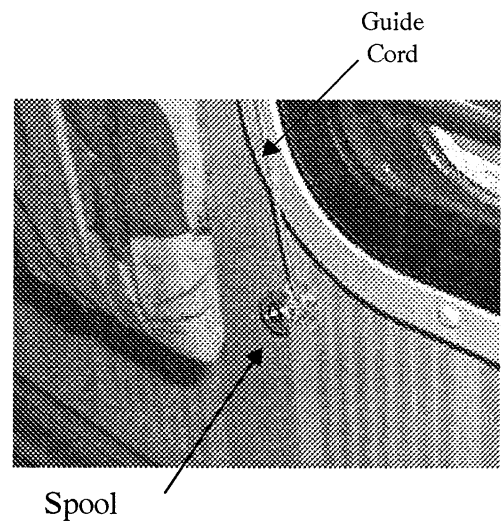

To loosen the tension, unwrap the guide cords from the spools one turn at a time until desired tension is achieved.

QUARTZ WALL CLOCK

To Replace Battery

The clock is held in place with bristle pad material.

Carefully remove the clock from the pad by alternately prying the left and right sides gently outward.

After replacing the battery, simply press the clock firmly back onto the bristle pad.

CAUTION

Sealants must be inspected every 6 months and resealed if necessary.

ROOF

The roof is made of Thermo-Panel materials like the walls and floor. It will support the weight of an average adult should it become necessary to repair the roof or roof mounted components. It is not recommended, however, that very large or heavy objects be carried on the roof while the vehicle is in motion. (See page 4-1 for roof loading specifications.) Always have damage to the roof area repaired immediately. Damaged or detached sealant around the vents, air conditioner, body-to-roof seams, etc., should also receive immediate attention. Delaying these repairs may allow water leakage and result in damage to interior ceiling and body panels, upholstery, etc.

UNDERBODY

Buildup of mud and dirt under the body can cause damaging rust on steel parts and can add needless weight to the vehicle. This, in effect, reduces the amount of cargo you can carry and remain with GVWR and GAWR limits.

Corrosive materials, such as those used for ice and snow removal and dust control, also accumulate on the underside of a vehicle. These materials should be removed by flushing the underbody regularly with water, especially areas where mud and other foreign materials collect.

EXTERIOR

The exterior surface of your motor home has an automotive finish. Frequent washing and thorough cleaning is recommended to prevent damage to the vehicle finish after exposure to damaging salts, calcium chloride, road tar, tree sap, insects and other foreign material. Never wash the vehicle in direct sunlight, while the vehicle surface is hot, or using hot water.

Do not use strong soaps or detergents for

washing the motor home. Always use a mild soap in warm water, a commercially prepared product for cleaning automotive finishes or your local car wash. Be careful when using pressure-type washers to avoid loosening exterior decals or sealants, etc.

After washing the motor home, carefully inspect caulking around window frames and vents and any other joints that may have separated. Re-caulking, if necessary, is quite simple. Appropriate compounds are sold at Winnebago and Itasca dealers, and the materials are quickly and easily applied. Also, inspect weather seals around door, etc., and if necessary have a dealer replace them immediately.

CAUTION

Never use a strong solvent such as lacquer thinner, or harsh abrasives on painted surfaces.

Waxing and Polishing

When water will not bead up and roll off the finish of your freshly washed vehicle, it's time to apply a new coat of hard wax (paste, not liquid) to the finish. Wax not only improves the appearance of the vehicle, but protects the finish against oxidation and corrosive substances.

We recommend using a wax that is compatible with painted and gel-coated fiberglass finishes.

If the finish begins to look dull or discolored, it may need to be cleaned with a polishing or cleaning compound.

NOTE: If you use a polish or a cleaning compound that does not contain a wax preservative, we recommend reapplying a coat of hard wax after cleaning or polishing the finish.

Care of Stripes and Decals

The pressure-sensitive decals on your coach require very little maintenance. They should be treated like any painted surface on your vehicle. Here are a few helpful hints on caring for decals:

- Wash decals with plain soap and water or any retail car wash soap. Always rinse thoroughly.
- Keep high-pressure wash nozzles at least 1 1/2 feet from edge of decals. High pressure water spray may cause edge lifting of decals.
- Test any cleaning solution on a small section of decal before using.
- Do Not use any aromatic solvents such as acetone, MEK, toluene, xylene, etc., on decals. Any solvent including alcohol may soften or smear colors.
- Do Not use lacquer thinner or paint on decals. Do Not overcoat decals with clear paint.
- Do Not let gasoline or other fuels drip and stay on decals for any length of time. Rinse immediately.

COMPARTMENT DOORS

Apply powdered graphite lubricant to compartment door latches periodically as necessary to keep latches operating smoothly.

If rubber door seals should become sticky, making the door hard to open, apply a rubber protectant such as 303™, Armor-All™, Son-of-a-Gun™, etc.

UPHOLSTERY, CARPETING AND DRAPERIES

We recommend a weekly routine of vacuuming all fabrics and carpet throughout the motor home to prevent an accumulation of dirt which can detract from the appearance and shorten the life of carpet and fabrics.

Carpets - See the carpet manufacturer's Carpet Care Guide in your Motor Home Operations manual binder. It includes detailed information on cleaning soils and removing stains from the fine carpet in your coach.

Upholstery

Some fabrics used in this motor home may contain fire retardant and lightfastness additives which can be damaged by use of improper cleaning products. Some water-based household cleaning products are not formulated for use on fabrics and may cause excessive shrinkage or fading. Always test any cleaning product on a

hidden area of fabric before using on visible areas. For best results, fabric cleaning should be referred to a professional carpet and upholstery cleaner.

NOTE: To minimize fading of upholstery, carpets and other interior fabrics caused by excessive sunlight, the drapes, blinds or shades should be closed when the motor home is parked for an extended period of time.

WARNING

When cleaning upholstery and fabric, do not use lacquer thinner, nail polish remover, laundry soaps, or bleach. Never use carbon tetrachloride, gasoline, or naphtha for any cleaning purpose. These materials may cause damage to the material being cleaned and most are highly flammable.

Spots and Stains

Spots or stains should be treated as soon as possible before they "set in" to avoid permanent damage. Always start from the outside of a spot or stain and work inward to avoid spreading it. Use a clean cloth or sponge and turn frequently to an unused area of the cloth or sponge as you clean.

Some stains or soils, such as lipstick, ink, grease or mustard, are extremely difficult or impossible to remove completely and should receive immediate attention. Consult a professional carpet and upholstery cleaner for assistance.

Vinyl Fabrics

Vinyl should be cleaned with a soft, damp cloth, and a mild detergent only. Do not use solvents. Solvents may damage the surface of the vinyl.

Draperies, Curtains and Bedspreads

These items may be woven from a variety of fabrics. We recommend that these be profession-

ally dry cleaned only. A five percent shrinkage may occur when you have these items dry cleaned.

CABINETRY

Wooden items may be cleaned with a soft cloth and a good quality wood finish cleaning product such as Guardsman™ or equivalent.

Vinyl simulated wood (Plus-Wood) panels may be cleaned with a mild, water based cleaner and a soft cloth. Do not use solvents on vinyl wood panels.

NOTE: Many cabinetry and furniture items throughout this motor home are constructed either partially or completely of real hardwoods. Because of natural variations in woodgrain density, slight differences in stain hue may exist between one item and another. This is the distinctive character and beauty of real wood.

Decorative Cabinet Mirrors and Windows

Use a good quality glass cleaner or mild soap and water solution. It is best to use a spray bottle to apply a light mist rather than saturating the surface. **WIPE DRY IMMEDIATELY. DO NOT ALLOW GLASS TO REMAIN WETTED FOR LONGER THAN A FEW SECONDS.** Prolonged moisture can cause the applique coating to lift from the surface of the glass.

Do not use sharp objects to scrape debris such as fly specks etc. Sharp objects can chip or lift the applique coating.

VINYL WALLBOARD

Decorative vinyl covered wallboards may be cleaned with a mild solution of water and isopropyl (rubbing) alcohol or a mild soap solution. Do not use solvents or abrasive cleaning products.

TABLES AND COUNTERTOPS

Work surfaces are covered with a plastic laminate that resists solvents, stains and abrasions. A coat of furniture wax applied to these surfaces on the counters and table will help preserve their beauty and make cleaning easier. Always clean the surface before applying wax.

STAINLESS STEEL SINK

The stainless steel sink can be cleaned with soap or detergent. Rinse thoroughly with warm water and wipe dry to avoid streaks.

Use a mild abrasive for stubborn stains. Work in the direction of the polish lines. To keep the original finish, polish with a wax cleaner and rub with a dry soft cloth.

WARNING

Salts, mustard and mayonnaise may cause pitting. If spilled, clean immediately.

BATHROOM

The tub and shower walls in the bathroom should be cleaned with a mild soap and water solution, or (to obtain maximum luster) use a good quality wax cleaner. Do not use an abrasive cleaner on the shower walls and tub. If the shower has a glass door, it is extremely important that abrasives not be used. Use only a good quality glass cleaner or mild detergent and water solution with a soft cloth to clean glass surfaces.

The bathroom lavatory is also a molded plastic material and should be cleaned with a mild soap and water solution. Abrasive cleaners or harsh detergents should not be used.

For instructions on the care of your fresh water toilet, refer to the information in your Motor Home Operation Manual binder.

DOORS AND WINDOWS

Windows may be periodically cleaned with a good quality glass cleaner or mild soap solution using a soft cloth. Use care when removing ice or frost from the windows. Always use a plastic ice scraper, never one made of metal. Use care when removing ice from the mirrors to protect the reflective surfaces.

Door locks and hinges should be lubricated periodically with powdered graphite to ensure trouble-free operation and to protect against freeze-up.

VEHICLE MAINTENANCE

(See also Safety Precautions, Section 1 of this manual).

CHASSIS SERVICE & MAINTENANCE

Consult the appropriate sections in your chassis operating guide for specific information regarding operating safety, service recommendations and maintenance schedules for the chassis section of your motor home.

ENGINE ACCESS - Chevy or Ford Chassis

FRONT ACCESS PANEL (HOOD)

Insert the tamper-resistant hood key into the hood locks and turn them to the right (clockwise) to unlock the hood.

Swing the hood outward and down. Do not let hood drop.

To close the hood, lift and swing inward. Turn key locks to the left (counterclockwise) to lock hood closed.

With the hood open, the engine oil dipstick, oil fill, radiator fill, power steering reservoir and windshield washer reservoir are accessible.

Some chassis also allow access to the engine air filter element.

ENGINE COVER (Chevy or Ford Chassis)

Removal of the engine cover allows an authorized service technician access to the engine for scheduled service and maintenance.

- Insert the supplied hex wrench into the hole in the lower rear edge of the engine cover.

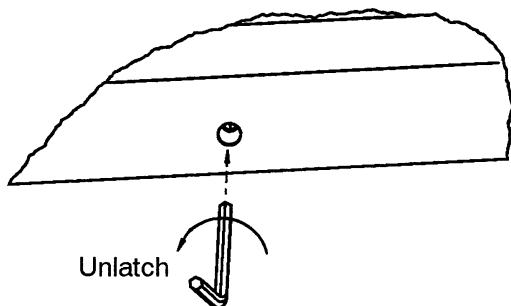

- Turn the hex wrench to the left (counterclockwise) to unlatch.
- Lift the rear end of the cover upward and pull the cover from the opening.
- To return the cover, position the front end of the cover first, then lower the rear end. It is important to be sure the front edge is pushed completely forward to the radiator cover to ensure an air-tight seal.
- Press the rear end of the cover down and turn the hex wrench to the right (clockwise) until the latch pulls the cover downward and stops.

ENGINE ACCESS - Freightliner Diesel Chassis

REAR ENGINE GRILLE

The diesel engine is located behind the large slotted grille in the rear of the vehicle. With the grille open, you can access the following service points:

- Engine Oil Dipstick ("Add" = 2 qts. low)
- Engine Oil Fill Cap
- Power Steering/Park Brake Fluid Reservoir
- Radiator Cap
- Engine Coolant Overflow Bottle
- Transmission Dipstick/Fill Tube
- Air Filter Restriction Indicator

Unlock the grille and swing it open upward. A catch is located on the backwall to hold the grille open.

ENGINE TOP COVER

The engine top cover is located beneath the rear bed. This cover is only removed for replacement of engine parts or if a complete view of the engine is needed for inspection. To do this, remove the mattress from the bed and lift the hinged bed board upward. Support the bed board with a prop rod while accessing engine.

Routine engine inspection can be performed (with protective clothing) under the left rear side of the vehicle, between the luggage compartment and engine exhaust muffler.

FUEL/WATER SEPARATOR

Diesel fuel often contains small quantities of water which can damage the engine if not filtered out. The fuel/water separator traps this water and prevents it from reaching the engine. The harmful water deposits must be drained from the separator canister during normal periodic service and maintenance to keep the fuel filtration system working effectively.

The fuel/water separator is located beneath the sidewall behind the rear wheels on the right (passenger) side of the coach.

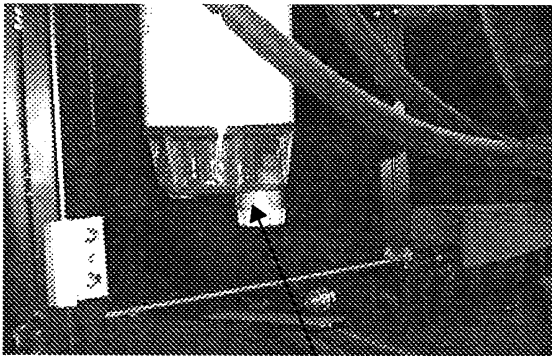

Fuel/Water Drain Valve

Place an appropriate container beneath the outlet and screw the water release valve open several turns. Drain any water deposits from the canister until clean diesel fuel flows from the valve. Close valve by hand. Do not over tighten.

Dispose of the drained liquid in an environmentally responsible manner, such as taking to a waste oil disposal.

ENGINE COOLING SYSTEM

Refer to your chassis operating guide for information and precautions on filling, servicing and checking the fluid level.

CAUTION
When refilling the coolant system of a vehicle equipped with a rear auxiliary automotive heater and motoraid water heater, be sure to allow for additional coolant capacity of the heater and its supply and return hoses.

TIRES

Low air pressure results in tire overloading and abnormal wear and also affects handling and fuel economy. Obtain proper inflation pressures from your chassis operating guide or tire manufacturer.

WARNING

Make sure all replacement tires are of the same size and ply rating as those installed as original equipment.

See the Vehicle Certification Label affixed to the lower inside of the driver's door for tire information.

SUSPENSION ALIGNMENT AND TIRE BALANCE

The front suspension and steering system of this vehicle was factory aligned using highly accurate equipment prior to delivery to the dealership. However, we recommend that alignment be checked and adjusted, if necessary, after you have fully loaded the motor home according to your personal needs. Thereafter, the alignment should be periodically inspected to help prevent uneven tire wear.

Any excessive or abnormal tire wear may indicate worn or misaligned suspension or steering, unbalanced tire or other tire/suspension problem.

Alignment can be affected by worn steering/suspension parts or by incidents which happen during driving, such as hitting a curb, pothole or railroad track, etc. Improper alignment can cause tires to roll at an angle and wear unevenly. It may also cause the vehicle to "pull" to the right or left. Have your dealer inspect your vehicle's suspension and steering components periodically for misalignment or wear.

Out-of-balance tires will not roll smoothly and can lead to annoying vibrations and uneven tread wear such as cupping and flat spots. Tires may need to be balanced if uneven wear is detected or if ride comfort decreases noticeably.

See your chassis operating guide for further information.

SECTION 9 CARE & MAINTENANCE

Sunflyer

WINDSHIELD WASHERS AND WIPERS

See your chassis operating guide for recommendations and precautions regarding washers and wipers.

LIGHTS

All exterior lights should be checked for proper operation each time the vehicle is prepared for a trip. Any bulbs which fail to light should be checked and replaced, when necessary, with a new bulb of the same size. A failure of more than one light, such as both taillights not operating, may indicate a burned out fuse. Check fuse and replace with one of the same rating when necessary. If a fuse is not the cause of the problem, the wiring system should be checked immediately by an authorized service center.

The headlight circuit is protected by an auto reset circuit breaker built into the headlight switch. An overload on the breaker will cause the lights to flicker on and off. Headlight wiring should be checked immediately anytime this condition is apparent. Refer to your chassis operating guide for further information.

AUTOMOTIVE 12-VOLT FUSES AND CIRCUIT BREAKERS

The automotive fuses and breaker are conveniently located on the automotive fuse block below the left side of the dash (ahead of driver's left foot).

The circuit breakers will pop outward if they are tripped. Simply push in to reset.

Always replace plug-in type fuses with those of the same amperage size.

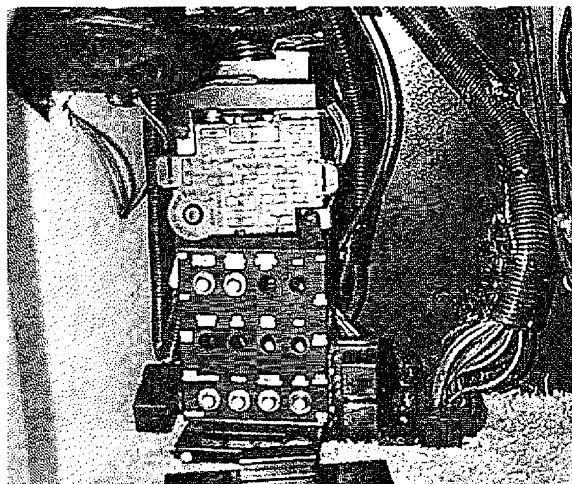
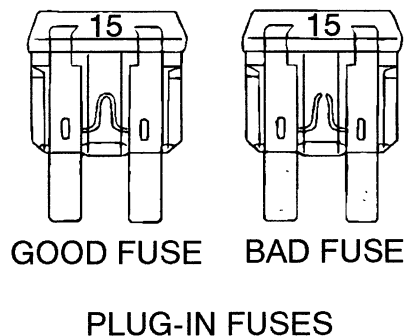

PREPARING VEHICLE FOR STORAGE

Properly preparing your vehicle for storage will lessen the possibility of damage to your vehicle. Prepare the motor home for vacancy just as you would if you were leaving your house for an extended period:

- Remove all perishables from cabinets and refrigerator
- Prop refrigerator door open.
- Turn off LP gas tank.
- Drain water heater, water tank and holding tank.
- Close shades to protect upholstery from sunlight

When storing your vehicle through the winter, or in cold climates, extra preparations need to be made to protect systems that can be damaged by freezing temperatures.

Cold Weather Storage Procedure (Winterizing)

1. Clean and dump holding tanks by following steps A, B, and C
 - A. Add water to the sewage holding tank by holding the toilet flush lever open with the water pump running. Add water to the waste water holding tanks by opening the kitchen, shower and lavatory faucets. Tanks should be about 1/4 to 1/3 full to rinse properly. Driving to a disposal site will normally loosen and rinse any waste material from the sides of the tank.
 - B. Completely drain the sewage and waste water holding tanks at an approved waste disposal site. Drain the sewage tank first so the following waste water can rinse any waste solids from the dump outlet and sewer hose.
 - C. Close dump valves and refit the dust cap onto the drain outlet.
2. Level the motor home and drain the entire plumbing system as described in the following steps.

3. Open all drain valves. (See the water system drain valve chart on page 7-7 for locations on your model.)

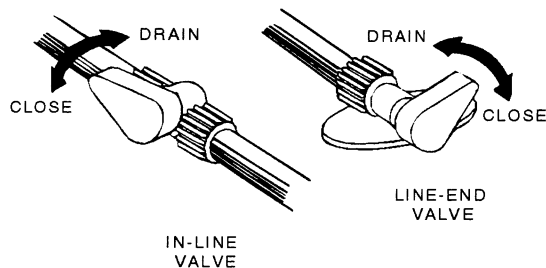

4. Remove and discard the water purifier filter cartridge:



Water Filter Assembly -
Below Galley Sink

- Raise the valve handle and turn the colored ring fully clockwise.
 - Twist the filter cartridge counterclockwise about a quarter-turn and pull it down and out of the filter head.
 - Place a container beneath the filter head and lower the valve handle to drain any water remaining in the filter lines.
5. Install the antifreeze diverter plug:

SECTION 10
STORING YOUR MOTOR HOME

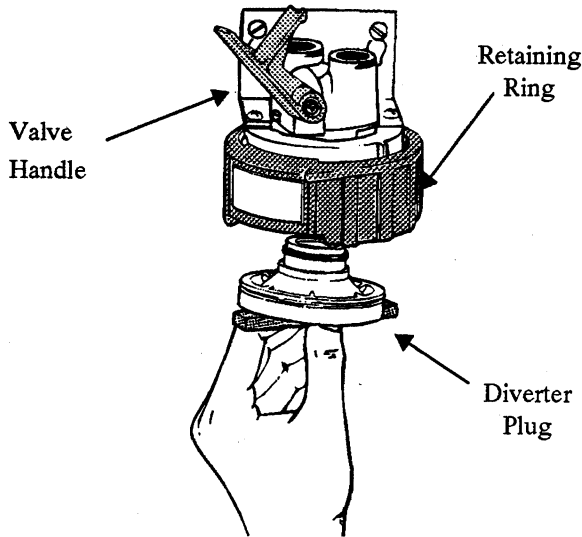

Pressure-Temperature relief valve at the top right portion of the tank to prevent air locking in the tank while draining.

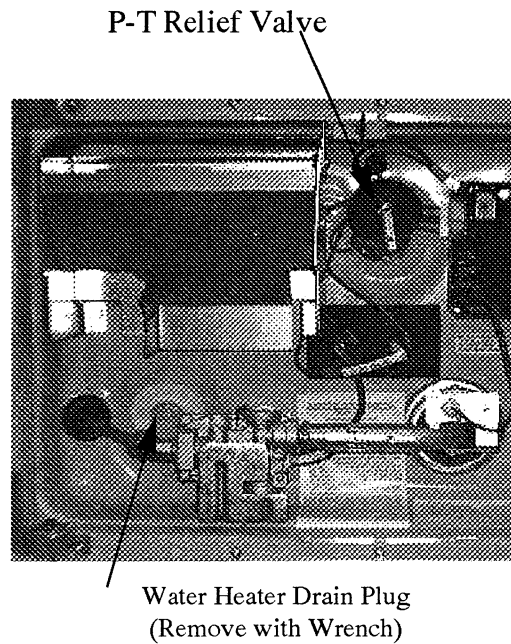

- Raise the valve handle and turn the colored ring fully clockwise.
- Hold the diverter by the support bar as shown and guide it up into the filter head with bar end approximately centered in colored ring cutout.
- Push the diverter up into the head as far as possible and turn it clockwise approximately a quarter-turn.
- Then turn colored ring fully counter-clockwise. The diverter should be locked in position between the head and colored ring.
- Lower valve handle to lock colored ring in place.

6. Turn the Water Pump switch ON to allow it to operate until you are done draining all faucets and toilet.
7. Open all faucets and shower head valves, including exterior shower.
8. Operate the toilet flush lever and hold until water stops flowing in the toilet. Then turn water pump switch OFF.
9. Turn off the water heater power switch before draining the water heater tank to avoid damage to the heating element. Drain the water heater by removing the plug from the base of the water heater tank, accessible from the outside of the coach. (Requires socket and ratchet.) Also open the

10. After water has stopped draining at all faucets and drain valves, connect a "blow-out" plug to the city water connection on the coach. Then use a hand pump or air compressor regulated to 30 psi or less to force air through the system. (A "blow-out" plug can be purchased at any Winnebago or Itasca dealer. P/N 701705-01-000.)

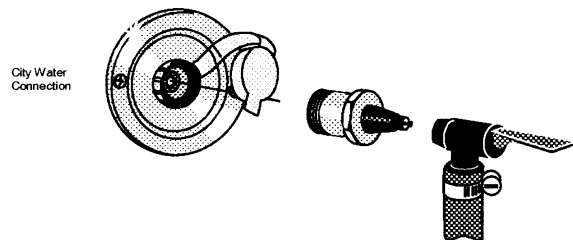

CAUTION
 Limit air pressure to 30 psi to avoid damage to pump or water lines.

NOTE: *DO NOT burst air into the system. This can damage the water pump. It is better to let air in slowly.*

11. Let air flow for five minutes until water is completely drained out of faucets and drain valves. Then close faucets one at a time.
12. Operate and hold toilet flush lever until water is completely drained from toilet.

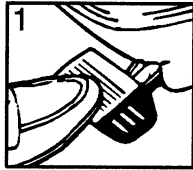

13. Now turn air pressure off and disconnect water purge adapters. Recap the city water connection to avoid contamination by dirt or insects.
14. Close all drain valves and faucets to avoid contamination by dirt or insects. Reinstall water heater drain plug and close P-T relief valve.
15. Pour about one cup of non-toxic RV antifreeze into the kitchen sink drain, bathroom sink drain and shower drain. This prevents any holding tank odors from entering the coach during storage.

WARNING

NEVER use automotive antifreeze/coolant in your RV water system. Auto antifreeze contains ethylene glycol which, if ingested, can cause blindness and can be fatal.

It is not necessary to add antifreeze to the toilet since the flush valve will be closed.

Do not add automotive antifreeze or caustic chemicals such as bleach or laundry detergents into the toilet bowl or holding tanks. Although these products may have a deodorizing effect, they may damage plastic and rubber parts in the system.

NOTE: *As an alternative to totally draining the plumbing system, you may winterize tanks and lines by pumping non-toxic RV antifreeze through the system. This product is available from your dealer and from most RV supply stores. Follow directions on the container to determine the correct amount to use for your coach.*

See "RV Antifreeze Water Line Winterization Systems" on page 10-4 for instructions on filling with RV antifreeze.

If your coach is equipped with the optional water heater by-pass valve, you can fill the hot water lines with antifreeze solution without filling the water heater tank. See page 8-8 for information on the by-pass valve.

CAUTION

Leave by-pass valve handle in NORMAL FLOW position if draining water and blowing out water lines. Place in BYPASS position ONLY when using antifreeze solution in water lines.

16. Place a bucket beneath the sewage drain valve outlet and re-drain the sewage and waste holding tanks of any clean water that entered during "blow-out" procedure.

Close dump valves to prevent valve shafts from rusting and to prevent entry by rodents and insects. Refit the dust cap onto the drain outlet.

Your drainage and fresh water systems are now totally winterized.

17. Have the vehicle chassis completely serviced and lubricated. Be sure radiator antifreeze protection level is sufficient for the lowest anticipated temperatures.
18. Wash and wax the coach.
19. Inspect all seams and seals around doors, windows, vents, and any other joints.

SECTION 10

STORING YOUR MOTOR HOME

Sunflyer

Replace or repair any that are damaged. Sealing materials and compounds can be purchased from your dealer. Badly damaged weather seals may need to be replaced by your dealer.

20. Close all windows and roof vents. Protect all appliance vent openings from contamination by animals or insects (e.g. bird nests, wasp nests, etc.)
21. Lubricate all door hinges and locks.
22. Clean the interior of the coach. Dirt and stains are more easily removed when fresh.
23. Remove all foods and items that may cause odors.
24. Clean and defrost the refrigerator. Leave the door slightly ajar to allow any odors to dissipate. Place an open box of baking soda inside the refrigerator to help absorb odors.
25. Turn the furnace thermostat switch on the bottom of the thermostat to OFF.
26. Turn auxiliary battery (Aux Batt) switch off. If your coach does not have an Aux Batt switch, disconnect all chassis and auxiliary battery cables.
27. Fully charge batteries. Batteries must have at least 80% charge to survive freezing temperatures and long periods of non-use.

NOTE: We do not recommend leaving the shoreline plugged in continuously during storage periods because the batteries can lose electrolytic fluids and become damaged from continuous charging without periodic use. We recommend following regular battery inspection and maintenance, especially in cold weather. See "Battery Maintenance" on page 6-9.

RV ANTIFREEZE WATER LINE WINTERIZATION SYSTEMS

Manual Winterization Valve - Standard

Your coach is equipped with a manually operated water line winterization system for your convenience in winterizing fresh water lines.

The system features a diverter valve and suction tube in-line between the tank and water

pump to draw non-toxic RV water system antifreeze into the water lines. This feature is located near the water pump and drain valves. See page 7-8 for location in your coach.

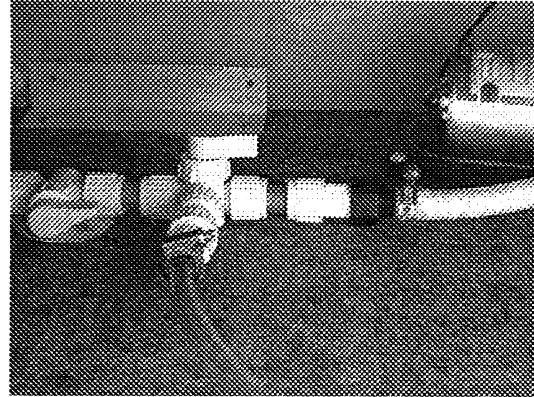

To Fill Lines with RV Water Line Antifreeze

- Turn water heater by-pass valve to BY-PASS position.
- Remove and save the protective cap from the end of the suction tube.
- Insert the end of the tube into a container of RV antifreeze solution.
- Turn the diverter valve handle so that it points toward the suction tube.
- Turn a water pump switch on.
- Open each cold water faucet handle in the coach one at a time until antifreeze solution just begins to flow from the faucet, then close.

When Done Adding RV Antifreeze:

- Turn water pump switch off.
- Turn the diverter valve handle so it points toward the water line to the pump as shown in the photo. This will stop the flow from the suction tube and revert the tank line flow to the pump.
- Replace the protective cap onto the end of the suction tube to keep out insects and debris when not in use.

Automatic Winterization System - Optional

Your coach may be optionally equipped with an electric pump powered automatic water line winterization system for your convenience in winterizing fresh water lines.

The reservoir tank for the RV water system antifreeze is located in the rear cargo compart-

ment on the passenger side of the coach. Remove the large black plug and use a funnel to fill the tank. Capacity is approximately 2 gallons. The tank may require refilling before the system is completely filled.

The winterization system switch panel is located near the floor below the refrigerator.

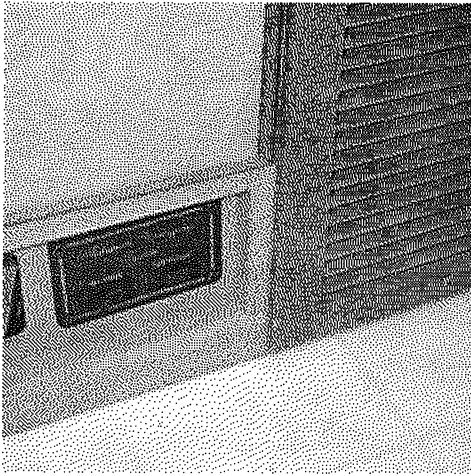

- Press the bypass switch to avoid filling the 6 gallon water heater tank with antifreeze after draining the water heater at the service panel on the outside of the coach. If you should wish to fill the water heater tank with anti-freeze solution, leave this switch off.
- Press the WINTERIZE switch to turn the winterizing pump system on to fill the lines with RV antifreeze solution.

REMOVAL FROM STORAGE

1. Completely air out the motor home.
2. Have the entire LP gas system checked for leaks.
3. Check window operation.
4. Check cabinet and door hinges. Lubricate with penetrating oil, if necessary.
5. Close all faucets and drain valves that are open. If necessary, reconnect toilet water line and close flush valve.
6. Add a few gallons of water to the fresh water tank and check for leaks especially at junctions. Also make sure all hangers and supports are securely in place. Sanitize the water system as outlined under "Disinfecting the Fresh Water System" in Section 7.
7. Check operation of all faucets to be sure faucet washers have not hardened during storage.
8. Check sealing valve in the toilet for proper operation and lubricate with silicone spray.
9. Add water to the holding tank using the toilet flush pedal. Check to be sure dump valve seals tightly.
10. Check around all appliances for obstructions and ensure that all vent openings are clear.
11. Start refrigerator and check for proper cooling.
12. Clean paneling and counter surfaces and apply a thin coat of wax.
13. Replace batteries if necessary and check out electrical system to make sure all lights and electrical components operate.
14. Check tires for proper cold inflation pressure.
15. After washing accumulated winter grime from the vehicle, it is important to carefully inspect the seams and sealants for separation or cracks that may have appeared around the window frames, vents and any other joints. Re-sealing is quite simple and the material is quickly and easily applied. Appropriate compounds are available from your dealer. Also inspect weather seals around doors, etc., and if necessary, have a dealer replace immediately.

A

Accumulator Tank	7-2
Air Conditioner, Automotive	2-13
Air Conditioner, Ducted Roof	8-10
Alarm, LP Gas	1-3
Alignment, Front Axle Tire	4-1
Alignment, Suspension and Tire Balance	9-5
Amplifier, Antenna Signal	8-11
Antenna, CB SWR Adjustment	2-15
Antenna, TV	8-10
Antenna Signal Amplifier	8-11
Antifreeze, RV Winterization Systems	10-4
Automatic Power Transfer Switch (Generator)	6-5
Automatic Winterizing System	10-5
Automotive (Starting) Batteries	6-7
Auto 12V Fuses & Circuit Breakers	6-7, 9-6
Auxiliary Battery Switch	2-14
Aux Start Switch	2-14
Auxiliary (Coach) Batteries	6-7
Auxiliary 110-Volt Generator	6-5 - 6-7

B

Bathroom, Care of	9-3
Batteries, Automotive (Starting)	6-7
Batteries, Auxiliary (Coach)	6-7
Battery Charger, Connecting	3-4
Battery Condition Meter	8-7
Battery Information	6-7
Battery Maintenance	6-9
Battery Switch, Aux	2-14
Beds, Converting for use	8-13
Before Driving your Vehicle	2-1
Before Entering your Vehicle	2-1
Binder, Motor Home Operation Manual	0-1
Black Water Holding Tank Flushing	7-5
Block Heater, Engine (Freightliner)	2-3
Brake, Parking	2-4
By-Pass Valve, Water Heater	8-8

C

Cabinets	9-3
Cable TV Hook-Ups	8-12
Campsite Selection	4-5
Capacities** Fuel Tank'	2-2
Fresh Water Tank '	7-1

Holding Tanks '	7-6
Water Heater'	8-10
Carbon Monoxide Alarm	1-5
Carbon Monoxide Warning	1-4
Carpets, Care of	9-2
Central Vacuum Cleaner - Optional	8-15
CB Antenna, SWR Adjustment	2-15
CB Radio Wiring	2-14
Charger Panel, Solar (Optional)	6-8
Charging Section	6-4
Chassis Operating Guide	0-1
Chassis Service and Maintenance	9-4
Checklist, Pre-Travel	4-3
Child Restraints	2-10
Circuit Breakers, 12-Volt	6-7, 9-6
Circuit Breakers, 110-Volt	6-3
City Water Hook-Up	7-3
Clock, Wall	8-15
Coach Leveling System	2-15
Cold Weather Storage (Winterizing)	10-1
Comfort Controls	2-12
Compact Disc (CD) Changer	2-14
Compartment Doors, Luggage	2-6
Condensation, Humidity and	4-6
Connecting a Battery Charger	3-4
Connecting the Shoreline	6-2
Control Center, Video	8-12
Converter, Electrical Power	6-3
Converter Overload Protector	6-4
Cooling System, Engine	9-5
Couch/Bed Conversion	8-13
Crank-Out Windows	8-15
Cruise Control	2-12

D

Day/Night Pleated Shades	8-15
DC-AC Electrical Inverter	8-13
Decals and Stripes	9-1
Defects, Reporting Safety	0-2
Defroster	2-13
Deluxe Sound System	2-13
Diesel Engine Block Heater	2-3
Diesel Fuel/Water Separator	9-5
Dinette/Bed Conversion	8-13

* Capacity chart is also conveniently located on the back of "To The Owner" page inside front cover of this manual.

INDEX



Disinfection of Fresh Water Tank 7-3
Door Handles and Locks..... 2-5
Doors and Windows, Care of..... 9-3
Doors, Luggage Compartment..... 2-6
Door Locks, Entrance 2-6
Drain Valves, Water 7-6, 7-8
Drainage System 7-5
Draperies, Care of..... 9-2
Drinking and Driving..... 0-2
Driver Seat 2-6
Driving Safety Precautions 1-1
Dual Rear Wheels 3-3
Dumping Holding Tanks 7-5

E

Effects of Prolonged Occupancy 4-6
Electrical Inverter, DC-AC 8-13
Electrical Outlets, 110-volt..... 6-5
Electrical Safety Precautions 1-3
Electrical System, 110-volt AC 6-1
Electrical System, 12-volt DC 6-7
Emergency Crank-In, Slide-Out Room..... 2-19
Emergency Equipment Checklist..... 4-3
Emergency Exits 1-5
Energy Management System, PowerLine..... 6-2
Engine Access..... 9-4
Engine Block Heater, (Freightliner) 2-3
Engine Cooling System 9-5
Engine Exhaust Brake (Freightliner) 2-5
Engine Overheat..... 3-5
Engine Top Cover..... 9-4
Entertainment Center, Exterior 8-13
Entrance Door Lock and Handle..... 2-5
Entrance Steps, Electric Powered 2-6
Equipment, Options and 0-1
Equipping for Travel..... 4-3
Exhaust Brake, Engine (Freightliner) 2-5
Exits, Emergency 1-5
Extending Slide-Out Room..... 2-18
Exterior Body Care 9-1
Exterior Entertainment Center 8-13
Exterior Features..... 0-4
Exterior Shower 7-4
External (City Water) Connector..... 7-3
External Power Cord (Shoreline)..... 6-1

F

Filling the Fuel Tank..... 2-2
Filter, Diesel Fuel/Water..... 9-5
Fire Extinguisher 1-5
Flushing Black Water Holding Tank 7-5
Formaldehyde Warning 1-4

Fresh Water Tank..... 7-1
Disinfection of 7-3
Drain 7-6
Filling 7-1
Fresh Water Toilet 8-14
Front Axle Tire Alignment 4-1
Fuel Pump Shutoff Switch (Ford)..... 2-3
Fuel Selection 2-2
Fuel Selection, Diesel 2-3
Fuel Tank Capacity 2-2
Fuel Tank, Filling 2-2
Fuel Tank, Filling Diesel 2-3
Fuel/Water Separator (Diesel) 9-5
Furnace , LP Gas 8-9

G

Gas Alarm, LP 1-3
Gas Leaks, LP 5-4
General Warnings 1-1
Generator, Auxiliary 110-Volt 6-5, 6-7
Generator Hourmeter 6-6
Ground Fault Circuit Interrupter..... 6-4

H

Hazard Warning Flashers..... 3-1
Heater, Diesel Engine (Freightliner) 2-3
Heater, Automotive..... 2-12
Holding Tank Level Indicators 8-7
Hourmeter, Generator 6-6
Humidity and Condensation 4-6

I

Instrument Panel 2-11
Interior Care 9-2, 9-4
Inverter, DC-AC Electrical 8-13

J

Jet Air Ride Park & Level System 2-16
Jump Starting 3-4

K

Keys 2-6

L

Leveling, Coach 2-15, 4-6
Leveling System, Coach 2-15
Lights 9-6
Loading, Roof 4-2
Loading the Vehicle 4-1
Locks, Entrance Door 2-6
Lounge Chairs..... 2-7
LP Gas Alarm 1-3

-
- LP Gas Furnace 8-9
 - LP Gas Leaks 1-2, 5-4
 - LP Gas Level 8-7
 - LP Gas Pressure Regulator 5-3
 - LP Gas Safety 5-1
 - LP Gas Selection..... 5-1
 - LP Gas Tank, Air in the 5-3
 - LP Gas Tank, Refilling 5-2
 - LP Gas Tank System..... 5-2
 - LP Gas, Travel with 5-3
 - LP Gas, Winter Use of 5-5
 - Luggage Compartment Doors..... 2-6
- M**
- Maximum Occupancy 4-1
 - Microwave Oven..... 8-6
 - Mirrors, Power Electric 2-9
 - Monitor, Rearview TV..... 2-10
 - Monitor Panel 8-6
 - Motor Aid Water Heater..... 8-9
 - Motor Home Operation Manual (Binder)..... 0-1
 - Mountain Driving 4-5
- N**
- Nighttime Driving..... 4-5
- O**
- Occupancy, Effects of Prolonged 4-6
 - Occupancy, Maximum 4-1
 - Operating the Oven 8-6
 - Operation Manual (Binder), Motor Home 0-1
 - Operators Manual 0-1
 - Options and Equipment 0-1
 - Outlets , 110-Volt 6-5
 - Oven Pilot 8-6
 - Overload Protector, Converter 6-4
- P**
- Park & Level System, Jet Air 2-16
 - Parking Brake 2-4
 - Phone Jack Locations..... 8-12
 - Pilot, Lighting Oven 8-7
 - Pleated Shades, Day/Night 8-15
 - Power Converter System 6-3
 - Power Electric Mirrors..... 2-9
 - PowerLine Energy Management System 6-2
 - Power Roof Vent 8-15
 - Power Seat, Driver Six-Way..... 2-7
 - Power Step, Entrance 2-6
 - Pre-Travel Checklist 4-3
 - Preparing Vehicle for Storage 10-1
 - Pressure Regulator, LP Gas 5-3
- Prolonged Occupancy, Effects of 4-6
 - Pump Switch, Water 7-2
- R**
- Radio/Cassette Player, Dash 2-13
 - Radio Switch..... 2-13
 - Radio Wiring, CB 2-14
 - Range and Oven 8-5
 - Range Hood 8-6
 - Rear Engine Access, Diesel 9-5
 - Rearview TV Monitor..... 2-10
 - Recovery Towing..... 3-3
 - Refrigerators 8-1 - 8-5
 - Regulator, LP Gas 5-3
 - Relief Valve, Water Heater..... 8-8
 - Removal from Storage 10-5
 - Reporting Safety Defects 0-2
 - Restraints, Child..... 2-9
 - Retracting Slide-Out Room 2-18
 - Roof Loading..... 4-2
 - Roof Maintenance..... 9-1
 - Roof Vent, Power 8-15
 - RV Antifreeze Winterization Systems..... 10-4
- S**
- Safe Use of LP Gas System 5-1
 - Safety Defects, Reporting 0-2
 - Safety Precautions..... 1-1 - 1-6, 3-2
 - Satellite TV System - Optional 8-12
 - Seat, Driver 2-8
 - Seat Belts and Child Restraints..... 2-8, 2-9
 - Seats 2-6, 2-7
 - Selecting Fuel Types, LP 5-1
 - Service Assistance 0-2
 - Severe Weather Information 4-4
 - Sewer Hook-Ups, Using On-Site 7-6
 - Shades, Day/Night Pleated 8-15
 - Shoreline, Connecting the 6-2
 - Shower, Exterior 7-4
 - Shower Hose Vacuum Breaker..... 7-4
 - Shutoff Switch, Fuel Pump (Ford)..... 2-3
 - Signal Amplifier, TV Antenna..... 8-11
 - Sink, Stainless Steel 9-3
 - Sleeping Facilities..... 8-13
 - Slider Windows..... 8-15
 - Slide-Out Living Room 2-17-2-20
 - Emergency Crank-In 2-19
 - Extending 2-18
 - Retracting 2-18
 - Travel Latches..... 2-17
 - Solar Charger Panel (Optional)..... 6-8
 - Solar Panel Wiring..... 6-8
-

INDEX



Sound Systems 2-13
Spare Tire 3-1
Speed Control (Cruise) 2-12
Spots and Stains 9-2
Start Switch, Aux 2-14
Starting and Stopping the Engine 2-2
Step, Electric Power Entrance 2-7
Storage, Preparing Vehicle for 10-1
Storage, Removal from 10-5
Stripes and Decals 9-1
Suspension Alignment and Tire Balance 9-5
Switch, Radio 2-13
SWR Adjustment, CB Antenna 2-15

T

Table and Countertop Surfaces 9-3
Tank , Fresh Water Filling 7-1
Tank Capacities, Water and Holding 7-5
Telephone Hook-Ups 8-12
Thermostat, Electronic - Furnace 8-9
Tire Alignment, Front Axle 4-1
Tire, Spare 3-1
Tire Balance, Suspension Alignment and 9-5
Tire Changing 3-2
Tires 9-5
Toilet, Fresh Water 8-14
Towing, Recovery 3-3
Trailer Towing 4-2
Trailer Wiring Connector 6-10
Travel Latches, Slide-Out Room 2-17
Travel Tips 4-3
Travel with LP Gas 5-3
TV Antenna 8-10
TV & Cable Hook-Ups, 8-12
TV Signal Amplifier 8-11
TV Monitor, Rearview (Backup Monitor) ... 2-10

U

Underbody Care 9-1
Upholstery 9-2
Using On-Site Sewer Hook-Ups 7-6

V

Vehicle Certification Label (VIN) 0-3
Vehicle Maintenance 9-4
Vents, Power Roof 8-15
Video Control Center 8-12
Vinyl Fabrics 9-3
Vinyl Wallboard 9-3
Voltage Inverter, DC-AC Electrical 8-13

W

Wall Clock, Quartz 8-15
Warnings:
Carbon Monoxide 1-4
Driving 1-1
Formaldehyde 1-4
Fuel & LP Gas 1-2
LP Gas Leaks 1-2
LP Gas Alarm 1-3
Electrical 1-3
Loading 1-3
Maintenance 1-4
Warranty 0-2
Water and Holding Tank Levels 8-7
Water Drain Valves 7-6, 7-8
Water Heater, Motor Aid 8-9
Water Heater 8-7
Water Heater By-Pass Valve 8-8
Water Heater Capacity 8-7
Water Line Drain Valves 7-6, 7-8
Water Pump 7-1
Water Pump Switch 7-2, 8-9
Water Purifier System 7-4
Water Tank, Disinfection of 7-3
Water Tank Filling 7-1
Weighing Your Loaded Vehicle 4-1
Wheels, Rear Dual 3-3
Wheel Nuts 3-3
Windows, Cleaning 9-4
Windows, Crank-Out 8-15
Window Shades, Pleated 8-15
Windows, Slider 8-15
Windows, Doors and 9-3
Windows, Emergency Exit 1-5
Windshield Washers and Wipers 9-6
Windshield Wiper/Washer Switch 2-12
Winter Use of LP Gas 5-5
Winterization Systems, RV Antifreeze 10-5
Winterizing 10-1 - 10-5
Wiring, CB Radio 2-14
Wiring, Trailer Connector 6-10

IMPORTANT SERIAL NUMBERS

Motor Home (Coach): Year _____ Model _____ Serial _____

Chassis: Make _____ Serial (VIN) _____

Air Conditioner: Brand _____ Model _____ Serial _____

Furnace: Brand _____ Model _____ Serial _____

Water Heater: Brand _____ Model _____ Serial _____

Power Converter: Brand _____ Model _____ Serial _____

110-Volt Generator: Brand _____ Model _____ Serial _____

Range Brand _____ Model _____ Serial _____

Microwave Oven: Brand _____ Model _____ Serial _____

Refrigerator Brand _____ Model _____ Serial _____

Television: Brand _____ Model _____ Serial _____

Video Cassette Player: Brand _____ Model _____ Serial _____

EMERGENCY INFORMATION

Dealer

Name _____

Address _____

Phone _____

INSURANCE POLICY

Company _____

Policy Number _____

Phone _____

1998

Sunflyer

Operator's Manual



Sunflyer

Built Proudly By Winnebago Industries